

I-Line™ Combo Panelboard

Distribution Panelboards

Catalog
2110CT1301

2013

Class 2110



Contents

Description	Page	Description	Page
Product Description	2	Features and Benefits	6
Standards	2	Accessories and Kits	8
Service	3	Available Ready-to-Install Kits	8
Enclosure Protection	4	Available Factory Installed Options	8
Main Circuit Breaker Panelboards	5	Accessories	9
Main Lugs-only Panelboards	5	General and Application Information	10
Solid Neutral	5	Enclosure Dimensions	11
Branch Circuit Breakers	5	Replacement Parts	19



by Schneider Electric

I-Line™ Combo Panelboard

Product Description



Single I-Line
Combo Panelboard



Duplex I-Line
Combo Panelboard

Product Description

The I-Line™ Combo Panelboard combines an NQ or NF lighting section with an I-Line power distribution section in a single panelboard. This is an industry-exclusive addition to the Schneider Electric Square D™ brand I-Line Power Distribution Panelboard offer, designed for use in both AC and DC systems. It is available in single or duplex configurations, which determine the number of included lighting sections. All main circuit breaker panelboards rated 800 A or less are suitable for use as service entrance.

I-Line Combo panelboards are available as 225–800 A main lugs only and 70–1200 A main circuit breakers. The I-Line Combo panelboards are designed to accept the following circuit breakers: FA, FH, FI, FY, HD, HG, HJ, HL, HR, JD, JG, JJ, JL, JR, LA, LD, LG, LH, LI, LJ, LL, LR, MG, MJ, PG, PJ, PK, PL, Q4, QB, QG, QJ, EDB, EGB, EJB, QO and QOB.

Standards

I-Line Combo panelboards are designed, manufactured, and tested to comply with the following standards:

Standard	Description
UL 50	Standard for electrical equipment enclosures
UL 67	Standard for panelboards
CSA C22.2, Nos. 29 and 94-1989	Standard for panelboards, including enclosed panelboards
NFPA 70	National Electrical Code (NEC)
CSA C22.1	Canadian Electrical Code (CEC)
NEMA PB 1	Standard for panelboards
W-P 115C Type 1 Class 1	Specification for circuit breaker panelboards
2000 IBC	US standard for seismic requirements
1995 NBCC	Canadian standard for seismic requirements

I-Line™ Combo Panelboard Product Description

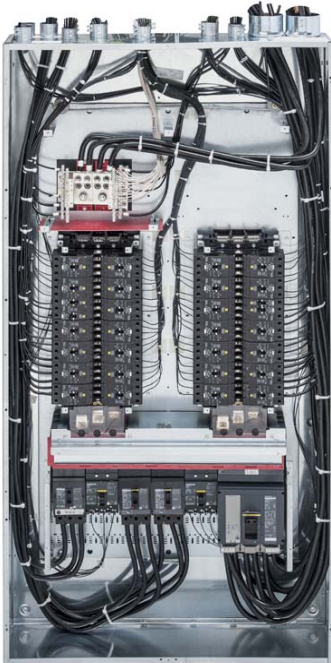

Service

The I-Line Combo distribution panelboards can be used on the following system voltages:

Vac	Phase	Wire
208Y/120	3	4
480Y/277	3	4
240/120	3	4
600Y/347	3	4
220/110	3	4
230/115	3	4
380/115	3	4
400/230	3	4
415/240	3	4
240	3	3

Vdc	Phase	Wire
48(NQ) ¹	—	2

¹ The DC rating of the entire panelboard is limited due to the 48 Vdc rating of QO circuit breakers used in the NQ section of the I-Line Combo panelboard.

Panelboard Configuration	I-Line Mounting Space	Maximum Amperage		Lighting Section Circuit Count		NEMA 1 Dimension in Inches (mm)			
				Section 1	Section 2	Height	Width	Depth	
Single	18 in. (457 mm)	600		30	—	86 (2184)	26 (660)	9.5 (241)	
				42	—	86 (2184)	26 (660)	9.5 (241)	
Single	22.5 in. (572 mm)	600		30	—	73 (1854)	32 (813)	9.5 (241)	
				42	—	91 (2311)	32 (813)	9.5 (241)	
Duplex ¹	22.5 in. (572 mm)	600		42	42	91 (2311)	32 (813)	9.5 (241)	
				54	30	91 (2311)	32 (813)	9.5 (241)	
Duplex	31.5 in. (800 mm)	800	1200	MLO	42	42	86 (2184)	44 (1118)	9.5 (241)
				MCB	54	30	86 (2184)	44 (1118)	9.5 (241)
			30	Optional Mounting Space ²	86 (2184)	44 (1118)	9.5 (241)		
			42	Optional Mounting Space ²	86 (2184)	44 (1118)	9.5 (241)		
			54 ³	Optional Mounting Space ²	86 (2184)	44 (1118)	9.5 (241)		

¹ Only available in the NQ lighting panelboard.

² Optional mounting space is only available on 800 A interiors, not 1200 A.

³ The 54 circuit with an optional mounting space is available for 800 A, but can only be used with 1, 2, or 3 lighting contactors.

I-Line™ Combo Panelboard

Product Description



**NEMA Type 1
Enclosure**



**NEMA Type 3R
Enclosure**

Enclosure Protection

Enclosure	Protects From These Environments:
Type 1	Indoor contact with the enclosed equipment
Type 3R ¹	Outdoor falling rain and sleet, ice
Type 4/4X Stainless ¹	Corrosion, hose-directed water, dust
Type 5 ¹	Indoor settling dust, falling dirt, dripping liquids
Type 12 ¹	Indoor circulating dust, falling dirt, dripping liquids

Type 1 Enclosures	Fronts	Surface and flush trims available as four-piece construction, standard (door not included). An optional four-piece trim with door is also available. Finished with gray-baked enamel electrodeposited over cleaned phosphatized steel (ANSI 49).
	Boxes	Galvanized steel in 26, 32, and 44-inch (660, 813, and 1118 mm) widths. Removable endwalls without knockouts.
Type 3R, 5, and 12 Enclosures		Gasketed door with vault handle and directory card holder
		Three-point latching
		End and side gutter trim
		No knockouts
		Removable drain screw for Type 3R
		Finished with gray-baked enamel electrodeposited over cleaned phosphatized steel (ANSI 49)

¹ Only available in 26 in. (660 mm) and 44 in. (1118 mm) width configurations.



Powerpact P-Frame 1200 A Main
(the maximum size circuit breaker for the I-Line Combo panelboard)



Powerpact L-Frame 250 A Main



Main Circuit Breaker Panelboards

- Accepts up to 1200 A main circuit breaker ²
- Available factory-assembled up to 1200 A or ready-to-install up to 800 A ²
- Cable entry can be top or bottom feed ³
- Suitable for use as service entrance equipment up to 800 A in the US
- Accepts plug-on I-Line main circuit breakers: LA/LH-frame, PowerPact™ L-frame, M-frame, and P-frame
- Available with a short circuit current rating (SCCR) up to 200 kA maximum
- Available with tin plated copper bus, silver plated copper bus, or tin plated aluminum bus ⁴
- Solid neutral is mounted at the top of the panelboard, as standard
- Available with compression lugs for I-Line circuit breakers; consult online *Digest* for details about compression lugs available for each circuit breaker type.

Main Lugs-only Panelboards

- Available factory-assembled or ready-to-install up to 800 A
- Accepts plug-on I-Line main lug kits ⁵
- Available with a short circuit current rating (SCCR) up to 200 kA maximum
- Available with tin plated copper bus, silver plated copper bus, or tin plated aluminum bus ⁴
- Cable entry can be top or bottom feed ³
- Solid neutral is mounted at the top of the panelboard, as standard
- Available with compression lugs for I-Line circuit breakers; consult online *Digest* for details about compression lugs available for each circuit breaker type.

Solid Neutral

- Mounts in main compartment above the lighting sections
- Does not take up interior circuit breaker mounting space
- UL/CSA Listed for use with aluminum or copper conductors
- Copper or aluminum neutral available
- 200% rated neutral available as a factory-assembled option up to 800 A

Branch Circuit Breakers

- NQ lighting sections accept QO and QOB circuit breakers, which are available from 10–150 A
- NF lighting sections accept E-frame circuit breakers, which are available from 15–110 A
- I-Line sections with 18 in. (457 mm), 22.5 in. (572 mm), or 31.5 in. (800 mm) of mounting space will accept thermal magnetic/basic electronic or electronic with ammeter or energy trip unit I-Line circuit breakers ⁶

² 1200 A main circuit breaker is allowed in US and Mexico only.

³ I-Line section is required to reside at the bottom of the panelboard.

⁴ Tin-plated aluminum bussing is only available on 225 A and 250 A configurations.

⁵ Plug-on lug kits include catalog numbers SL400, SL800, and S33931. Please refer to the most current *Digest* to determine which one is required.

⁶ Available with compression lugs for I-Line circuit breakers. Consult online *Digest* for details about compression lugs available for each circuit breaker type.

I-Line™ Combo Panelboard

Features and Benefits

Features and Benefits

Listed below are some of the benefits of the I-Line Combo panelboard.

Ease of Installation

The I-Line Combo panelboard provides a simple, quick installation due to the minimal amount of materials needed and the benefit of only having to install a single panelboard.

Reduced Footprint

By combining a power panel with up to two lighting panels in a single enclosure, the I-Line Combo panelboard saves significant space at any site.

Industry Exclusive Design

The innovative, hard-bussed connection between the NQ or NF lighting sections and the I-Line power section are friction-stir welded to ensure a reliable connection.

Simple to Retrofit

I-Line Combo panelboard enclosures fit into the same footprint on sites where an existing I-Line power panelboard resides, providing easy upgrades of electrical equipment.

Flexible Circuit Breaker Configuration

Due to the I-Line Combo panelboard's ability to house I-Line molded case circuit breakers as well as cost effective miniature circuit breakers, it provides not only a more economical solution but an adaptable solution tailored to each customer.

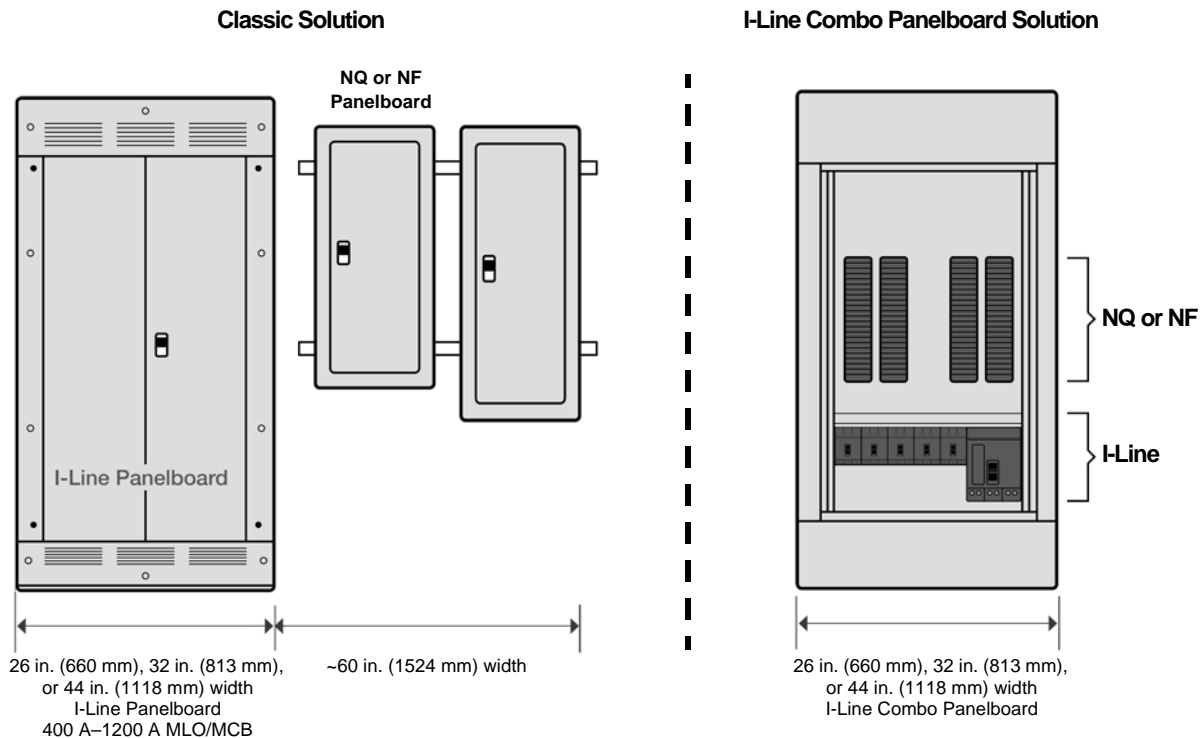

I-Line™ Combo Panelboard Features and Benefits

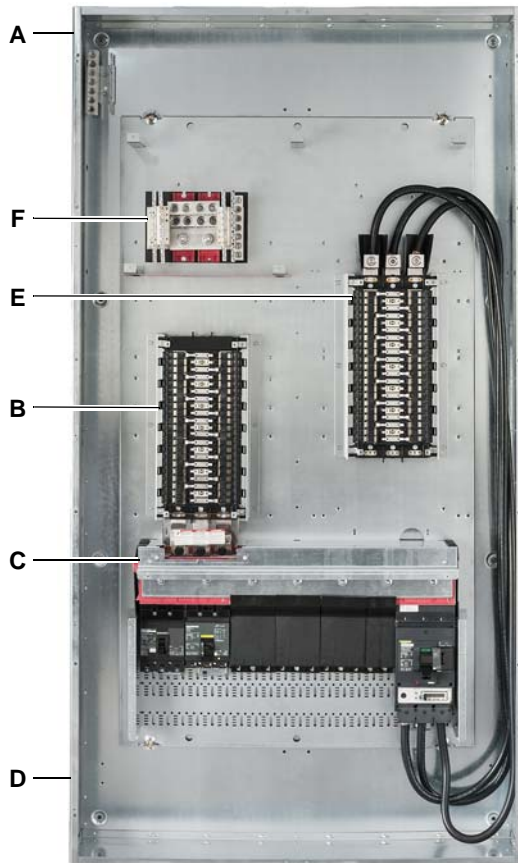

Duplex I-Line Combo Panelboard
with Optional Mounting Space

- A. I-Line Combo panelboards are available as Type 1, 3R, 4/4X, 5, and 12 enclosures in 26 in. (660 mm), 32 in. (813 mm), or 44 in. (1118 mm) box widths. Placing the lighting sections and I-Line power section in the same box reduces the total footprint on a project site. All enclosures offer either high-quality galvanized or stainless steel, providing extra protection for the panelboard's interior components.
- B. Schneider Electric NQ or NF lighting sections are hard bussed to the I-Line power section. With the lighting sections and power section in the same enclosure, cost-conscious customers will benefit from flexible circuit breaker configurations.
- C. The I-Line power section is mounted horizontally and available in 18 in. (457 mm), 22.5 in. (572 mm), or 31.5 in. (800 mm) mounting space configurations. The stacked bus structure offers unrestricted circuit breaker placement options. Due to the circuit breaker's "plug-on" type connection, the jaws on each circuit breaker create a firm grip on the bus bar during high-level short circuit conditions. The only tool needed for installing an I-Line circuit breaker is a screwdriver, making it the industry's quickest and easiest installation.
- D. Wireway in the I-Line Combo panelboard offers ample room for wire bending, utilizing standard installation practices. This enclosure's design is installer friendly.
- E. The I-Line Combo panelboard duplex configuration, with optional mounting space (pictured at left), provides the capability for future site growth. Ready-to-install kits are available as cable-fed field installable options that are mounted in the available space. This allows for individual shut down of the right section instead of discontinuing power to the entire panelboard. The additional mounting space can be utilized for many applications including:

Ready-to-Install Kits

- Dual 18 circuit section assembly
- Single 18 circuit section with contactor mounting assembly
- Additional 42 circuit section assembly
- Contactor mounting kit for up to three contactors

Factory Assembled Options⁷

- Powerlink™ lighting section in 42 or 54 circuit configurations⁸

- F. The solid neutral in the I-Line Combo panelboard is included as standard.

⁷ Options listed above for ready-to-install configurations can be ordered as cable fed factory assembled configurations.

⁸ Powerlink sections will be available only on the left side of the I-Line Combo panelboard.

I-Line™ Combo Panelboard Accessories and Kits

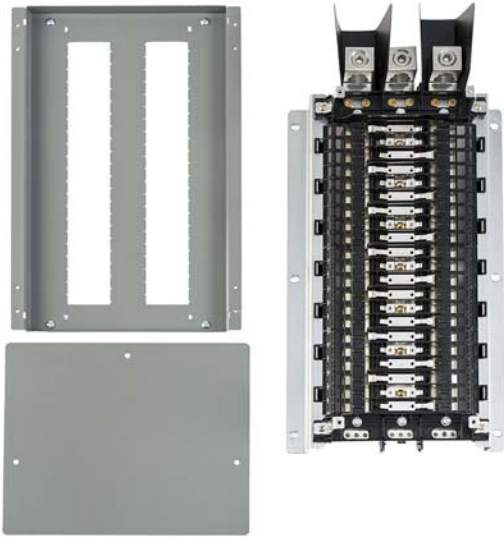

42 Circuit NQ Ready-to-Install Kit

Accessories and Kits

Available Ready-to-Install Kits

To provide future job site growth, ready-to-install 42 circuit NQ or NF lighting sections make it possible to install additional circuits in the field. Ready-to-install dual 18 circuit assemblies are also available as field installable accessories.

Lighting Section Type	Circuit Count	Amperage	Catalog Number
NF (600Y/347 Vac Max)	18 (with contactor kit)	125	NFICRT418C1C
	Dual 18	125	NFICRT418L1C
	42	250	NFICRT442L2C
		400	NFICRT442L4C
		600	NFICRT442L6C
NQ (240/120 Vac Max)	18 (with contactor kit)	100	NQICRT418C1C
	Dual 18	100	NQICRT418L1C
	42	225	NQICRT442L2C
		400	NQICRT442L4C
		600	NQICRT442L6C

Lighting Section Type	Catalog Number
Contactor Adaptor Kit ¹	NQINF18903KIT

¹ See the most updated version of the *Digest* for contactor assemblies.



Ready-to-Install
Lighting Contactor Kit

Available Factory Installed Options

All available options that may be installed on the lighting section mounting pan can be ordered factory assembled. Powerlink lighting sections can only be placed on the left lighting section. One, two, or three lighting contactors can be included per the specifications below:

- For 100 A contactors or less, up to three contactors may be installed on the mounting pan.
- For 150 A to 225 A contactors, up to two contactors may be installed on the mounting pan.

Accessories

Solid Neutral

The solid neutral mounts in either the upper-right or upper-left section of the enclosure and does not take up interior circuit breaker mounting space. Copper or aluminum neutral is available.

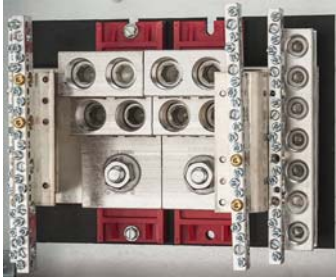

Ground Bars

Equipment ground bars, available in copper or aluminum, mount in the panelboard box, providing convenient termination of equipment-grounding conductors.



Blank fillers

Blank fillers are required to cover unused mounting space in I-Line panelboards. Filler extensions are also available to provide clear visibility of the circuit breaker LCD screen, if ammeter, or energy trip units on PowerPact circuit breakers are selected.

Optional Communication Capabilities

The I-Line Combo panelboard has optional communication capabilities with any PowerPact standard, ammeter or energy Micrologic™ trip unit. This option, which requires the addition of a 14 in. (356 mm) wide extension, provides the I-Line Combo panelboard with ample space for communications equipment and easy customer access to the compartment. The box extension can be placed on either the left or right side of the panelboard for additional flexibility.

PowerPact with Micrologic Molded Case Circuit Breakers

Standard, ammeter, or energy Micrologic trip units are available within I-Line Combo panelboard. PowerPact circuit breakers allow for metering down to 15 A and can:

- Measure power information and energy usage patterns
- Monitor events and deviations from normal operations
- Provide predictive maintenance indicators
- Access data locally on the circuit breaker LCD screen

Optional access to data through front display modules and Modbus™ communications are also available.



I-Line™ Combo Panelboard

General and Application Information

General and Application Information

The information below includes the available circuit breakers offered in the I-Line Combo panelboard. For more detailed information concerning circuit breaker ratings, terminal data, and lug information, see Section 9 of the current Schneider Electric *Digest*, available through the following link: <http://products.schneider-electric.us/products-services/online-digest/>.



Table 1: QO Circuit Breaker Family (15 A–150 A)

Branch Prefix	Availability			Interrupting Rating
	1-Pole	2-Pole	3-Pole	
QO/QOB	10–70 A	10–125 A	10–100 A	10,000 A
QO-VH/QOB-VH	15–30 A	15–150 A	15–150 A	22,000 A
QH/QHB	15–30 A	15–30 A	15–30 A	65,000 A



Table 2: E-Frame Circuit Breaker Family (15 A–110 A)

Branch Prefix	Availability			Interrupting Rating ¹	
	1-Pole	2-Pole	3-Pole	480/277 Vac	800Y/347 Vac
EDB	15–70 A	15–110 A	15–110 A	18,000 A	14,000
EGB	15–70 A	15–110 A	15–110 A	35,000 A	18,000
EJB	15–70 A	15–110 A	15–110 A	65,000 A	25,000

¹ Series ratings are also available.



Table 3: I-Line Circuit Breaker Family (15 A–1200 A)^{1, 2}

Circuit Breaker Type	Max. Circuit Breaker Amperage	Main Circuit Breaker or Main Lug
Plug-on main circuit breaker	400	LA/LH frame
	600	L frame
	800	M frame
	800	P frame
	1200	P frame
Plug-on main lug	400	SL400
	800	SL800, S33931 ³
Branch circuit breaker	100	F frame
	150	H frame
	225	Q frame
	250	J frame
	600	L frame
	800	M frame
	1200	P frame

¹ Interrupting ratings for I-Line circuit breakers can be found in the most current edition of the *Digest*.

² Main lug configurations are available as 15 A and above; main circuit breaker configurations are available as 100 A and above.

³ S33931 can be used as a main or branch circuit breaker on 800 A interiors or as a branch only on 1200 A interiors.



H-, J-, L-, M- and P-frame PowerPact I-Line circuit breakers will be available in the I-Line Combo panelboard. F-frame and Q-frame I-Line circuit breakers are available, as well. (F-frame not pictured.)

Enclosure Dimensions

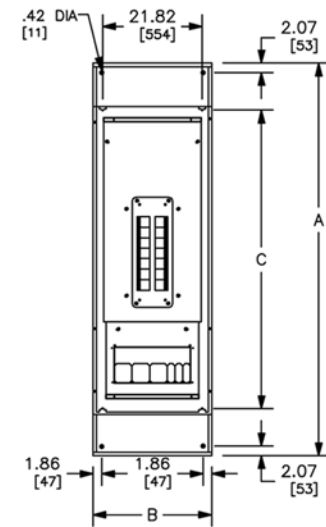

TYPICAL BOX WITH INTERIOR

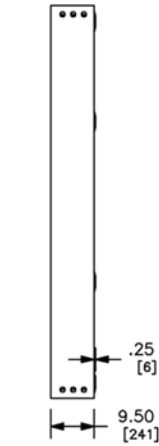

TYPICAL BOX
SIDE VIEW

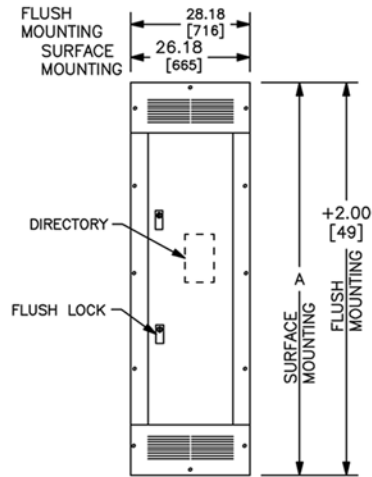

TYPICAL 4 PIECE
TRIM WITH DOOR

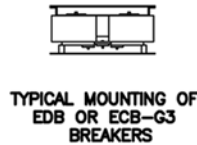
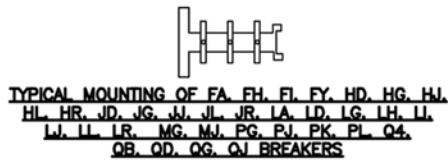

TYPICAL MOUNTING OF
EDB OR ECB-G3
BREAKERS

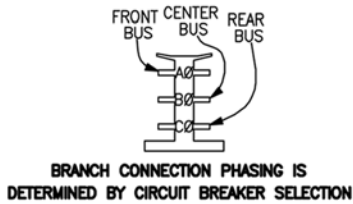

BRANCH CONNECTION PHASING IS
DETERMINED BY CIRCUIT BREAKER SELECTION



TYPICAL MOUNTING OF
QO OR QOB BREAKERS

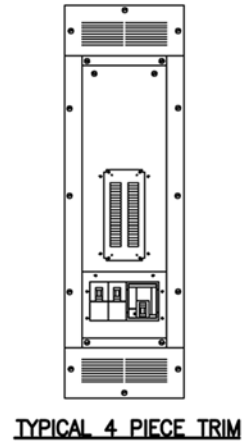

TYPICAL 4 PIECE TRIM

REFER TO DP CATALOG CLASS 2110 FOR
ADDITIONAL INFORMATION

I-LINE COMBO PANELBOARDS MEET
THE APPLICABLE REQUIREMENTS OF
UL AND CSA.

BOX: CODE GAUGE STEEL WITH REMOVABLE
BLANK ENDWALLS.

FRONT: CODE GAUGE STEEL, GRAY BAKED
ENAMEL FINISH ELECTRODEPOSITED
OVER CLEANED PHOSPHATIZED STEEL.

LOCK: (COVERS WITH DOORS) HAVE (2)
FLUSH LOCKS WITH NSR-251 KEY.

FOR NEMA TYPE 3R ENCLOSURE,
PLEASE REFER TO PBA850.

DUAL DIMENSIONS: INCHES
MILLIMETERS

MAXIMUM MLO OR BACK FEED MAIN AMPERE RATING	INCHES OF I-LINE MOUNTING SPACE	NUMBER OF LIGHTING SECTION CIRCUITS	A		B		C			
			IN	MM	IN	MM	IN	MM		
600A	18	30	86.00	2184	26.00	660	65.40	1585		
600A, W/9" BOTTOM EXTENSION			95.00	2413	26.00	660	65.40	1585		
600A, W/9" TOP EXTENSION			95.00	2413	26.00	660	65.40	1585		
600A, W/14" WIDE EXTENSION			86.00	2184	40.00	1016	65.40	1585		
600A			42	42	86.00	2184	26.00	660	65.40	1585
600A, W/9" BOTTOM EXTENSION					95.00	2413	26.00	660	65.40	1585
600A, W/9" TOP EXTENSION		95.00			2413	26.00	660	65.40	1585	
600A, W/14" WIDE EXTENSION		86.00			2184	40.00	1016	65.40	1585	

DWG# PBA801

I-Line™ Combo Panelboard Enclosure Dimensions

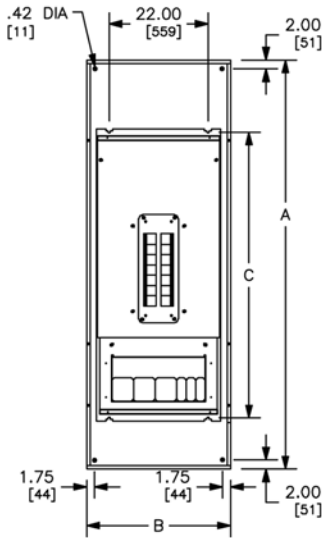

TYPICAL BOX WITH INTERIOR



TYPICAL BOX SIDE VIEW

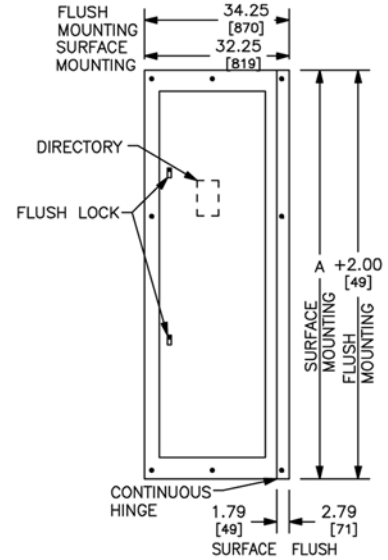

TYPICAL HINGED TRIM

TYPICAL MOUNTING OF FA, FH, FI, FY, HD, HG, HJ, HL, HR, JD, JG, JJ, JL, JR, LA, LD, LG, LH, LI, LJ, LL, LR, MG, MJ, PG, PJ, PK, PL, Q4, QB, QD, QG, QJ BREAKERS

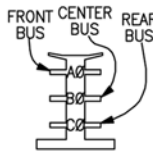

BRANCH CONNECTION PHASING IS DETERMINED BY CIRCUIT BREAKER SELECTION

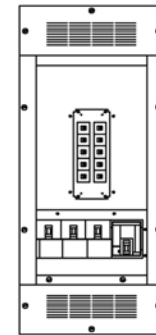
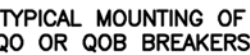

TYPICAL 4 PIECE TRIM

DUAL DIMENSIONS: INCHES MILLIMETERS

REFER TO DP CATALOG CLASS 2110 FOR ADDITIONAL INFORMATION

I-LINE COMBO PANELBOARDS MEET THE APPLICABLE REQUIREMENTS OF UL AND CSA.

BOX: CODE GAUGE STEEL WITH REMOVABLE BLANK ENDWALLS.

FRONT: CODE GAUGE STEEL. GRAY BAKED ENAMEL FINISH ELECTRODEPOSITED OVER CLEANED PHOSPHATIZED STEEL.

LOCK: (COVERS WITH DOORS) 73.00/[1854] - 91.00/[2311] HIGH FRONTS HAVE (2) FLUSH LOCKS WITH NSR-251 KEY.

MAXIMUM MLO OR BACK FEED MAIN AMPERE RATING	INCHES OF I-LINE MOUNTING SPACE	NUMBER OF LIGHTING SECTION CIRCUITS	A		B		C		
			IN	MM	IN	MM	IN	MM	
600A	22.5	30	73.00	1854	32.00	813	47.10	1196	
600A, W/9" BOTTOM EXTENSION			82.00	2083	32.00	813	47.10	1196	
600A, W/9" TOP EXTENSION			82.00	2083	32.00	813	47.10	1196	
600A, W/14" WIDE EXTENSION			73.00	1854	46.00	1168	47.10	1196	
600A			42	91.00	2311	32.00	813	65.10	1654
600A, W/9" BOTTOM EXTENSION				100.00	2540	32.00	813	65.10	1654
600A, W/9" TOP EXTENSION		100.00		2540	32.00	813	65.10	1654	
600A, W/14" WIDE EXTENSION		91.00		2311	46.00	1168	65.10	1654	
600A		54		91.00	2311	32.00	813	65.10	1654
600A, W/9" BOTTOM EXTENSION				100.00	2540	32.00	813	65.10	1654
600A, W/9" TOP EXTENSION			100.00	2540	32.00	813	65.10	1654	
600A, W/14" WIDE EXTENSION			91.00	2311	46.00	1168	65.10	1654	

DWG# PBA802

I-Line™ Combo Panelboard Enclosure Dimensions

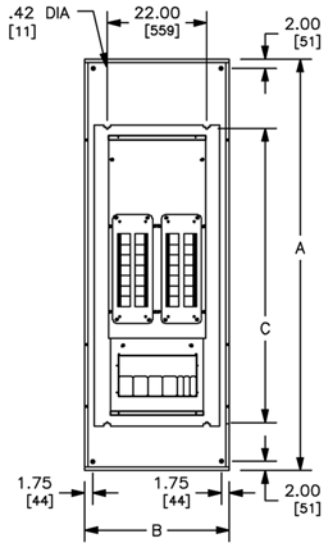

TYPICAL BOX WITH INTERIOR

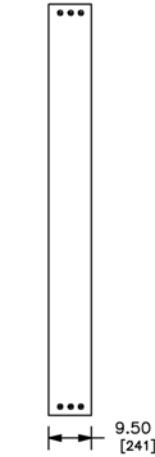

TYPICAL BOX SIDE VIEW

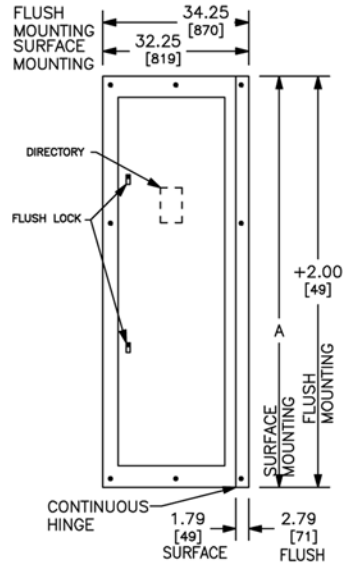

TYPICAL HINGED TRIM

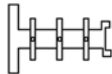

TYPICAL MOUNTING OF FA, FH, FI, FY, HD, HG, HJ, HL, HR, JD, JG, JJ, JL, JR, LA, LD, LG, LH, LJ, LJ, LL, LR, MG, MJ, PG, PJ, PK, PL, Q4, QB, QD, QG, QJ BREAKERS

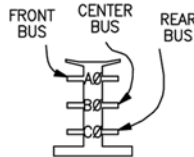

BRANCH CONNECTION PHASING IS DETERMINED BY CIRCUIT BREAKER SELECTION



TYPICAL MOUNTING OF QO OR QOB BREAKERS

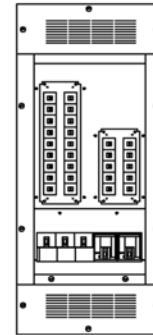

TYPICAL 4 PIECE TRIM

REFER TO DP CATALOG CLASS 2110 FOR ADDITIONAL INFORMATION

I-LINE COMBO PANELBOARDS MEET THE APPLICABLE REQUIREMENTS OF UL AND CSA.

BOX: CODE GAUGE STEEL WITH REMOVABLE BLANK ENDWALLS.

FRONT: CODE GAUGE STEEL, GRAY BAKED ENAMEL FINISH ELECTRODEPOSITED OVER CLEANED PHOSPHATIZED STEEL.

LOCK: (COVERS WITH DOORS) 73.00/[1854] - 91.00/[2311] HIGH FRONTS HAVE (2) FLUSH LOCKS WITH NSR-251 KEY.

DUAL DIMENSIONS: INCHES MILLIMETERS

MAXIMUM MLO OR BACK FEED MAIN AMPERE RATING	INCHES OF I-LINE MOUNTING SPACE	NUMBER OF LIGHTING SECTION CIRCUITS		A		B		C	
		LEFT	RIGHT	IN	MM	IN	MM	IN	MM
600A	22.5	42	42	91.00	2311	32.00	813	65.10	1654
600A, W/9" BOTTOM EXTENSION				100.00	2540	32.00	813	65.10	1654
600A, W/9" TOP EXTENSION				100.00	2540	32.00	813	65.10	1654
600A, W/14" WIDE EXTENSION		91.00	2311	46.00	1168	65.10	1654		
600A		54	30	91.00	2311	32.00	813	65.10	1654
600A, W/9" BOTTOM EXTENSION				100.00	2540	32.00	813	65.10	1654
600A, W/9" TOP EXTENSION	100.00			2540	32.00	813	65.10	1654	
600A, W/14" WIDE EXTENSION	91.00	2311	46.00	1168	65.10	1654			

DWG# PBA803

I-Line™ Combo Panelboard Enclosure Dimensions

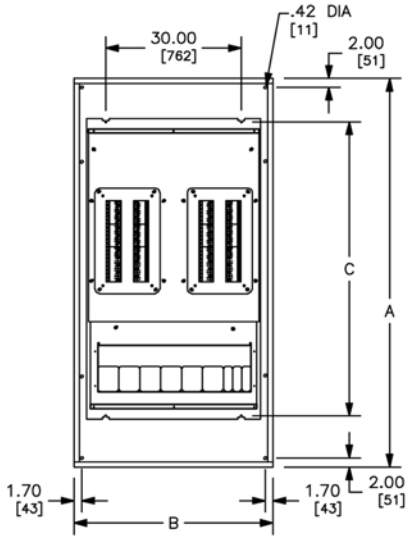

TYPICAL BOX WITH INTERIOR



TYPICAL BOX SIDE VIEW

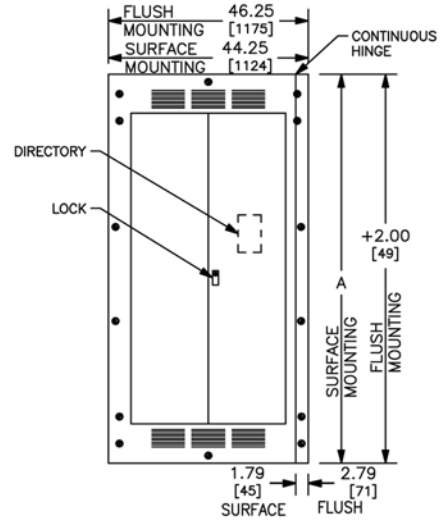

TYPICAL HINGED TRIM

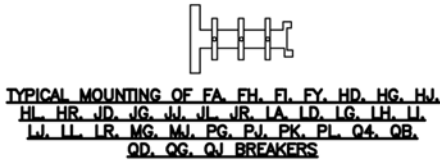

TYPICAL MOUNTING OF EDB OR ECB-G3 BREAKERS

TYPICAL MOUNTING OF QO OR QOB BREAKERS

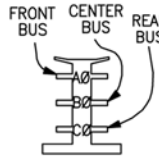

BRANCH CONNECTION PHASING IS DETERMINED BY CIRCUIT BREAKER SELECTION

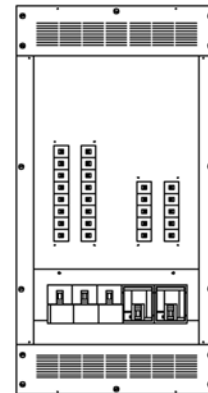

TYPICAL 4 PIECE TRIM

DUAL DIMENSIONS: INCHES MILLIMETERS

REFER TO DP CATALOG CLASS 2110 FOR ADDITIONAL INFORMATION

I-LINE COMBO PANELBOARDS MEET THE APPLICABLE REQUIREMENTS OF UL AND CSA.

BOX: CODE GAUGE STEEL WITH REMOVABLE BLANK ENDWALLS.

FRONT: CODE GAUGE STEEL. GRAY BAKED ENAMEL FINISH ELECTRODEPOSITED OVER CLEANED PHOSPHATIZED STEEL.

LOCK: (COVERS WITH DOORS) HAVE 3 POINT ESCUTCHEON FLUSH LOCK WITH NSR-251 KEY.

FOR NEMA TYPE 3R ENCLOSURE, PLEASE REFER TO PBA853

MAXIMUM MLO OR BACK FEED MAIN AMPERE RATING	INCHES OF I-LINE MOUNTING SPACE	NUMBER OF LIGHTING SECTION CIRCUITS		A		B		C	
		LEFT	RIGHT	IN	MM	IN	MM	IN	MM
800A	31.5	42	42	86.00	2184	44.00	1118	65.10	1654
800A, W/6" BOTTOM EXTENSION				92.00	2337	44.00	1118	65.10	1654
800A, W/6" TOP EXTENSION				92.00	2337	44.00	1118	65.10	1654
800A, W/12" BOTTOM EXTENSION				98.00	2489	44.00	1118	65.10	1654
800A, W/12" TOP EXTENSION				98.00	2489	44.00	1118	65.10	1654
800A, W/14" WIDE EXTENSION				86.00	2184	58.00	1473	65.10	1654
800A		54	30	86.00	2184	44.00	1118	65.10	1654
800A, W/6" BOTTOM EXTENSION				92.00	2337	44.00	1118	65.10	1654
800A, W/6" TOP EXTENSION				92.00	2337	44.00	1118	65.10	1654
800A, W/12" BOTTOM EXTENSION				98.00	2489	44.00	1118	65.10	1654
800A, W/12" TOP EXTENSION				98.00	2489	44.00	1118	65.10	1654
800A, W/14" WIDE EXTENSION				86.00	2184	58.00	1473	65.10	1654

NOTE: UTILIZATION OF 600KCMIL REQUIRES IN USE OF A 6" BOTTOM EXTENSION

DWG# PBA804

I-Line™ Combo Panelboard Enclosure Dimensions

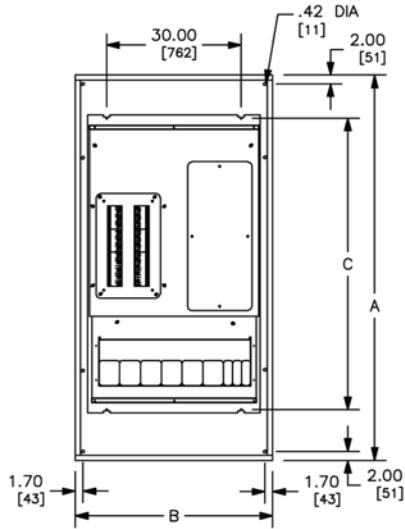

TYPICAL BOX WITH INTERIOR

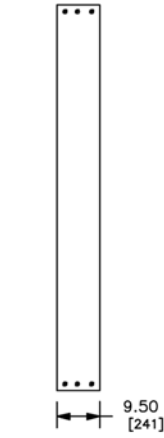

TYPICAL BOX SIDE VIEW

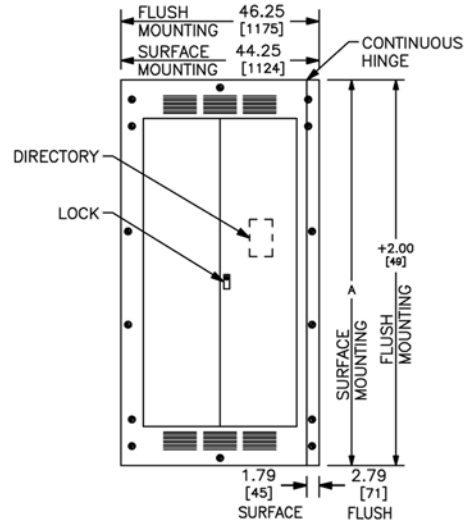

TYPICAL HINGED TRIM

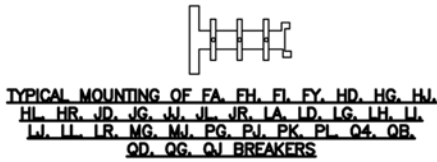

TYPICAL MOUNTING OF FA, FH, FI, FY, HD, HG, HJ, HL, HR, JD, JG, JW, JL, JR, LA, LD, LG, LH, LI, LJ, LL, LR, MG, MJ, PG, PJ, PK, PL, Q4, QB, QD, QG, QJ BREAKERS



TYPICAL MOUNTING OF EDB OR ECB-G3 BREAKERS



TYPICAL MOUNTING OF QO OR QOB BREAKERS

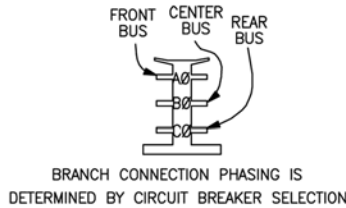

BRANCH CONNECTION PHASING IS DETERMINED BY CIRCUIT BREAKER SELECTION

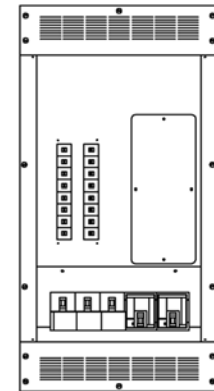

TYPICAL 4 PIECE TRIM

REFER TO DP CATALOG CLASS 2110 FOR ADDITIONAL INFORMATION

I-LINE COMBO PANELBOARDS MEET THE APPLICABLE REQUIREMENTS OF UL AND CSA.

BOX: CODE GAUGE STEEL WITH REMOVABLE BLANK ENDWALLS.

FRONT: CODE GAUGE STEEL, GRAY BAKED ENAMEL FINISH ELECTRODEPOSITED OVER CLEANED PHOSPHATIZED STEEL.

LOCK: (COVERS WITH DOORS) HAVE 3 POINT ESCUTCHEON FLUSH LOCK WITH NSR-251 KEY.

FOR NEMA TYPE 3R ENCLOSURE, PLEASE REFER TO PBA854

DUAL DIMENSIONS: INCHES MILLIMETERS

MAXIMUM MLO OR BACK FEED MAIN AMPERE RATING	INCHES OF I-LINE MOUNTING SPACE	NUMBER OF LIGHTING SECTION CIRCUITS		A		B		C	
		LEFT	RIGHT	IN	MM	IN	MM	IN	MM
800A	31.5	42	OPTIONAL MOUNTING SPACE	86.00	2184	44.00	1118	65.10	1654
800A, W/6" BOTTOM EXTENSION				92.00	2337	44.00	1118	65.10	1654
800A, W/6" TOP EXTENSION				92.00	2337	44.00	1118	65.10	1654
800A, W/12" BOTTOM EXTENSION				98.00	2489	44.00	1118	65.10	1654
800A, W/12" TOP EXTENSION				98.00	2489	44.00	1118	65.10	1654
800A, W/14" WIDE EXTENSION				86.00	2184	58.00	1473	65.10	1654

NOTE: UTILIZATION OF 600KCMIL REQUIRES IN USE OF A 6" BOTTOM EXTENSION

DWG# PBA805

I-Line™ Combo Panelboard Enclosure Dimensions

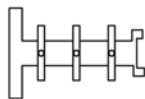
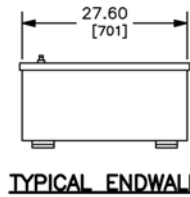
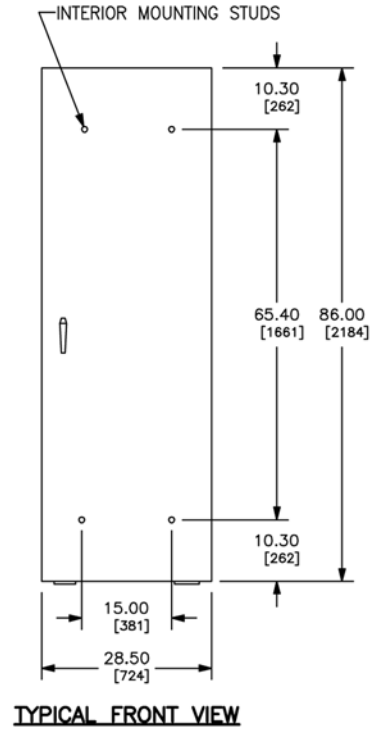
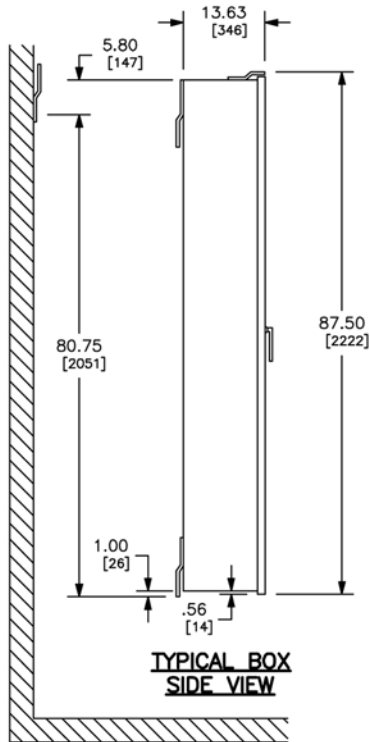

**TYPICAL MOUNTING OF FA, FH, FI, FY, HD, HG, HJ,
HL, HR, JD, JG, JJ, JL, JR, LA, LD, LG, LH, LI,
LJ, LL, LR, MG, MJ, PG, PJ, PK, PL, Q4,
QB, QD, QG, QJ BREAKERS**

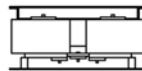

**TYPICAL MOUNTING OF
EDB OR ECB-G3
BREAKERS**

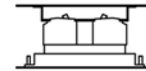

**TYPICAL MOUNTING OF
QO OR QOB BREAKERS**

I-LINE COMBO PANELBOARDS MEET THE APPLICABLE REQUIREMENTS OF UL AND CSA.

BOX: GRAY BAKED ENAMEL FINISH ELECTRODEPOSITED OVER CLEANED PHOSPHATIZED STEEL. INCLUDES HINGED COVER. MOUNTS TO WALL WITH MOUNTING CHANNEL AND SWINGABLE MOUNTING BRACKET.

LOCK: CHROME-PLATED HANDLE LOCK. NSR-251 KEY CHANGE. NO PROVISIONS FOR PADLOCK.

■ REFER TO DP CATALOG CLASS 2110 FOR ADDITIONAL INFORMATION.

FOR NEMA TYPE 3R/12 ENCLOSURE FOR THE I-LINE COMBO PANELBOARD.

DUAL DIMENSIONS: INCHES
MILLIMETERS

MAXIMUM MLO OR BACK FEED MAIN AMPERE RATING	INCHES OF I-LINE MOUNTING SPACE	NUMBER OF LIGHTING PANEL CIRCUITS
600A	18	30 42

DWG# PBA850

I-Line™ Combo Panelboard Enclosure Dimensions

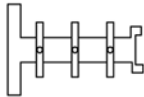
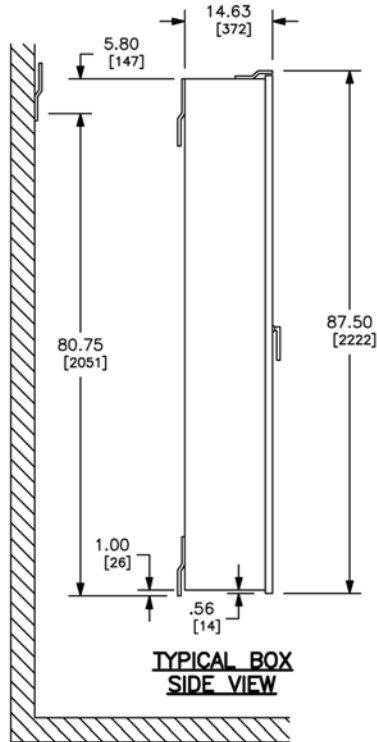

TYPICAL MOUNTING OF FA, FH, FL, FY, HD, HG, HJ, HL, HR, JD, JG, JJ, JL, JR, LA, LD, LG, LH, LJ, LJ, LL, LR, MG, MJ, PG, PJ, PK, PL, Q4, QB, QD, QG, QJ BREAKERS

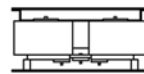
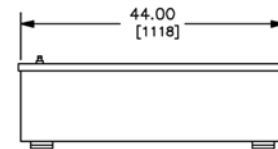
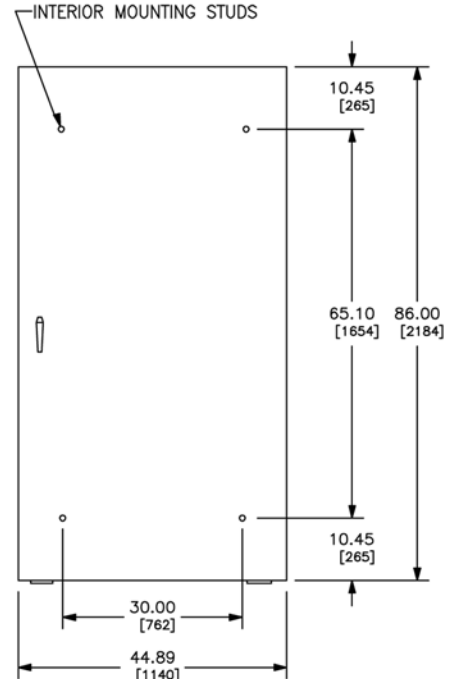

TYPICAL MOUNTING OF EDB OR ECB-G3 BREAKERS

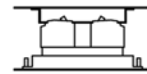

TYPICAL MOUNTING OF QO OR QOB BREAKERS

I-LINE COMBO PANELBOARDS MEET THE APPLICABLE REQUIREMENTS OF UL AND CSA.

BOX: GRAY BAKED ENAMEL FINISH ELECTRODEPOSITED OVER CLEANED PHOSPHATIZED STEEL. INCLUDES HINGED COVER. MOUNTS TO WALL WITH MOUNTING CHANNEL AND SWINGABLE MOUNTING BRACKET.

LOCK: CHROME-PLATED HANDLE LOCK. NSR-251 KEY CHANGE. NO PROVISIONS FOR PADLOCK.

■ REFER TO DP CATALOG CLASS 2110 FOR ADDITIONAL INFORMATION.

FOR NEMA TYPE 3R/12 ENCLOSURE FOR THE I-LINE COMBO PANELBOARD.

DUAL DIMENSIONS: INCHES MILLIMETERS

MAXIMUM AMPERE RATING	I-LINE MOUNTING SPACE	NUMBER OF LIGHTING CIRCUITS	
		LEFT	RIGHT
800	31.5	54	30
		42	42

DWG# PBA853

I-Line™ Combo Panelboard Enclosure Dimensions

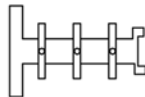
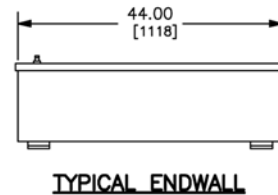
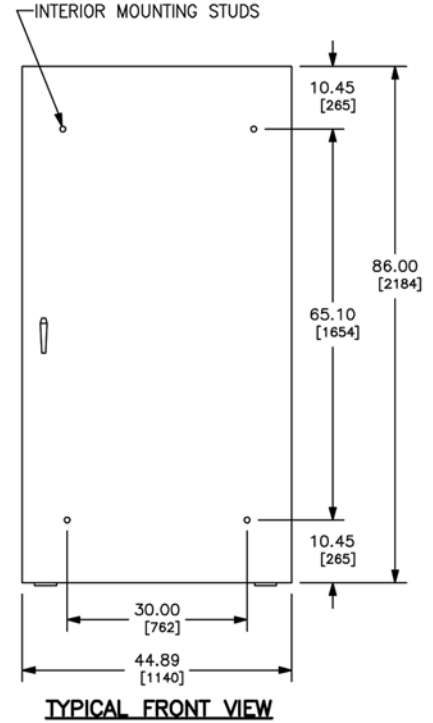
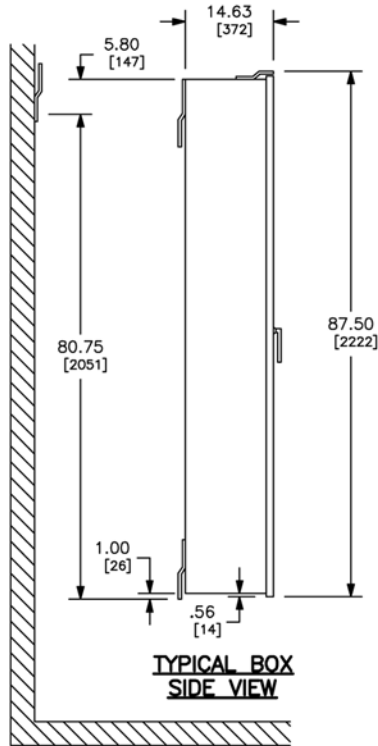

TYPICAL MOUNTING OF FA, FH, FI, FY, HD, HG, HJ, HL, HR, JD, JG, JJ, JL, JR, LA, LD, LG, LH, LI, LJ, LL, LR, MG, MJ, PG, PJ, PK, PL, Q4, QB, QD, QG, QJ BREAKERS

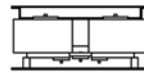

TYPICAL MOUNTING OF EDB OR ECB-G3 BREAKERS

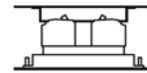

TYPICAL MOUNTING OF QO OR QOB BREAKERS

I-LINE COMBO PANELBOARDS MEET THE APPLICABLE REQUIREMENTS OF UL AND CSA.

BOX: GRAY BAKED ENAMEL FINISH ELECTRODEPOSITED OVER CLEANED PHOSPHATIZED STEEL. INCLUDES HINGED COVER. MOUNTS TO WALL WITH MOUNTING CHANNEL AND SWINGABLE MOUNTING BRACKET.

LOCK: CHROME-PLATED HANDLE LOCK. NSR-251 KEY CHANGE. NO PROVISIONS FOR PADLOCK.

■ REFER TO DP CATALOG CLASS 2110 FOR ADDITIONAL INFORMATION.

FOR NEMA TYPE 3R/12 ENCLOSURE FOR THE I-LINE COMBO PANELBOARD.

DUAL DIMENSIONS: INCHES
MILLIMETERS

MAXIMUM AMPERE RATING	I-LINE MOUNTING SPACE	NUMBER OF LIGHTING CIRCUITS	
		LEFT	RIGHT
800A	31.5	42	OPTIONAL MOUNTING SPACE

DWG# PBA854

Replacement Parts

I-Line Combo Panelboard Replacement Master Deadfront Assembly

Unit Size	Unit Assembly or Catalog Number	Replacement Deadfront Catalog Number
26 in. (660 mm) wide	CP18864N3Q2C	RPLCP18864N3Q2C
	CP18864N3Q2	RPLCP18864N3Q2
	CP18864N4Q2C	RPLCP18864N4Q2C
	CP18864N4Q2	RPLCP18864N4Q2
	CP18864N3F2C	RPLCP18864N3F2C
	CP18864N3F2	RPLCP18864N4F2
	CP18864N4F2C	RPLCP18864N4F2C
	CP18864N4F2	RPLCP18864N4F2
	CP18866N3Q4C	RPLCP18866N3Q4C
	CP18866N4Q4C	RPLCP18866N4Q4C
	CP18866N3F4C	RPLCP18866N3F4C
	CP18866N4F4C	RPLCP18866N4F4C
	32 in. (813 mm) wide	CP23734N3Q2C
CP23734N3Q2		RPLCP23734N3Q2
CP23914N4Q2C		RPLCP23914N4Q2C
CP23914N4Q2		RPLCP23914N4Q2
CP23914N5Q2C		RPLCP23914N5Q2C
CP23914N5Q2		RPLCP23914N5Q2
CP23734N3F2C		RPLCP23734N3F2C
CP23734N3F2		RPLCP23734N3F2
CP23914N4F2C		RPLCP23914N4F2C
CP23914N4F2		RPLCP23914N4F2
CP23914N5F2C		RPLCP23914N5F2C
CP23914N5F2		RPLCP23914N5F2
CP23736N3Q4C		RPLCP23736N3Q4C
CP23916N4Q4C		RPLCP23916N4Q4C
CP23916N5Q4C		RPLCP23916N5Q4C
CP23736N3F4C		RPLCP23736N3F4C
CP23916N4F4C		RPLCP23916N4F4C
CP23916N5F4C		RPLCP23916N5F4C
CP23916N44Q4C	RPCP23916N44Q4C	
CP23916N53Q4C	RPCP23916N53Q4C	
44 in. (1118 mm) wide	CP32866N44Q4C	RPCP32866N44Q4C
	CP32866N53Q4C	RPCP32866N53Q4C
	CP32866N4BQ4C	RPCP32866N4BQ4C
	CP32866N44F4C	RPCP32866N44F4C
	CP32866N53F4C	RPCP32866N53F4C
	CP32866N4BF4C	RPCP32866N4BF4C
	CP32868N44Q6C	RPCP32868N44Q6C
	CP32868N53Q6C	RPCP32868N53Q6C
	CP32868N3BQ6C	RPCP32868N3BQ6C
	CP32868N4BQ6C	RPCP32868N4BQ6C
	CP32868N5BQ6C	RPCP32868N5BQ6C
	CP32868N44F6C	RPCP32868N44F6C
	CP32868N53F6C	RPCP32868N53F6C

Schneider Electric USA, Inc.
1415 S. Roselle Road
Palatine, IL 60067 USA
1-888-778-2733
www.schneider-electric.us

© 2013 Schneider Electric All Rights Reserved
I-Line™, Micrologic™, Modbus™, Powerlink™, PowerPact™, and Square D™ are trademarks
owned by Schneider Electric Industries SAS or its affiliated companies. All other trademarks are
the property of their respective owners.

2110CT1301

08/2013