

# Altivar Process ATV600

Variable Speed Drives for Asynchronous and Synchronous Motors

## EthernetIP Modbus TCP Manual - VW3A3720

04/2016



---

The information provided in this documentation contains general descriptions and/or technical characteristics of the performance of the products contained herein. This documentation is not intended as a substitute for and is not to be used for determining suitability or reliability of these products for specific user applications. It is the duty of any such user or integrator to perform the appropriate and complete risk analysis, evaluation and testing of the products with respect to the relevant specific application or use thereof. Neither Schneider Electric nor any of its affiliates or subsidiaries shall be responsible or liable for misuse of the information contained herein. If you have any suggestions for improvements or amendments or have found errors in this publication, please notify us.

No part of this document may be reproduced in any form or by any means, electronic or mechanical, including photocopying, without express written permission of Schneider Electric.

All pertinent state, regional, and local safety regulations must be observed when installing and using this product. For reasons of safety and to help ensure compliance with documented system data, only the manufacturer should perform repairs to components.

When devices are used for applications with technical safety requirements, the relevant instructions must be followed.

Failure to use Schneider Electric software or approved software with our hardware products may result in injury, harm, or improper operating results.

Failure to observe this information can result in injury or equipment damage.

© 2016 Schneider Electric. All rights reserved.

# Table of Contents



|                  |                                                                       |    |
|------------------|-----------------------------------------------------------------------|----|
|                  | <b>Safety Information</b> .....                                       | 7  |
|                  | <b>About the Book</b> .....                                           | 11 |
| <b>Chapter 1</b> | <b>Presentation</b> .....                                             | 13 |
|                  | Hardware Overview .....                                               | 14 |
|                  | Software Overview .....                                               | 15 |
| <b>Chapter 2</b> | <b>Basics</b> .....                                                   | 17 |
| 2.1              | Introduction .....                                                    | 18 |
|                  | Introduction .....                                                    | 19 |
|                  | Network Layer Supported Functions/Protocols .....                     | 20 |
|                  | TCP and UDP Protocol .....                                            | 21 |
| 2.2              | Modbus TCP Features .....                                             | 23 |
|                  | Modbus TCP Frames .....                                               | 24 |
|                  | Modbus TCP Servers .....                                              | 25 |
|                  | Supported Modbus TCP Functions .....                                  | 26 |
|                  | Application Profile with Modbus TCP .....                             | 27 |
| 2.3              | Ethernet IP Features .....                                            | 28 |
|                  | EtherNet/IP .....                                                     | 29 |
|                  | Cyclical Exchanges (Implicit Exchanges) .....                         | 30 |
|                  | Messaging (Explicit Exchanges) .....                                  | 33 |
|                  | Timeout Monitoring .....                                              | 34 |
| 2.4              | CIP Object .....                                                      | 35 |
|                  | Supported Object Classes .....                                        | 36 |
|                  | Identity Object (01 hex) .....                                        | 37 |
|                  | Message Router Object (02 hex) .....                                  | 40 |
|                  | TCP/IP Interface Object (F5 hex) .....                                | 41 |
|                  | Ethernet Link Object (F6 hex) .....                                   | 44 |
|                  | Assembly Object (04 hex) .....                                        | 46 |
|                  | Connection Manager Object (06 hex) .....                              | 48 |
|                  | Motor Data Object (28 hex) .....                                      | 50 |
|                  | Control Supervisor Object (29 hex) .....                              | 51 |
|                  | AC/DC Drive Object (2A hex) .....                                     | 53 |
|                  | Application Object (70 hex to C7 hex) / Explicit Messaging .....      | 56 |
|                  | Base Energy Object (4E hex) .....                                     | 57 |
|                  | Electrical Energy Object (4F hex) .....                               | 59 |
| <b>Chapter 3</b> | <b>Hardware Setup</b> .....                                           | 61 |
|                  | Hardware Presentation .....                                           | 62 |
|                  | Firmware Version .....                                                | 63 |
|                  | Installation of the Module .....                                      | 64 |
|                  | Electrical Installation .....                                         | 65 |
|                  | Cable Routing Practice .....                                          | 66 |
| <b>Chapter 4</b> | <b>Software Setup</b> .....                                           | 69 |
| 4.1              | Basic Settings .....                                                  | 70 |
|                  | IP Parameter Settings .....                                           | 71 |
|                  | [Device Name] <i>P A n</i> .....                                      | 72 |
|                  | [ETH Option IP Mode] <i>, n 1 0</i> .....                             | 73 |
|                  | [Eth Option IP] <i>, C 1 1 , C 1 2 , C 1 3 , C 1 4</i> .....          | 74 |
|                  | [Eth Option Subnet Mask] <i>, n 1 1 , n 1 2 , n 1 3 , n 1 4</i> ..... | 75 |
|                  | [Eth Option Gate Add] <i>, G 1 1 , G 1 2 , G 1 3 , G 1 4</i> .....    | 76 |
|                  | [Enable FDR] <i>F d V 1</i> .....                                     | 77 |
|                  | [FDR Action] <i>F d A 1</i> .....                                     | 78 |
|                  | [FDR Operating State] <i>F d S 1</i> .....                            | 79 |

|                  |                                                              |            |
|------------------|--------------------------------------------------------------|------------|
|                  | [FDR Error Status] <i>F d r l</i> .....                      | 80         |
|                  | [MAC @] <i>π π C α</i> .....                                 | 81         |
|                  | [ETH opt Rx frames] <i>E r X α</i> .....                     | 82         |
|                  | [ETH opt Tx frames] <i>E t X α</i> .....                     | 83         |
|                  | [ETH opt error frames] <i>E E r α</i> .....                  | 84         |
|                  | [Actual rate] <i>π r d</i> .....                             | 85         |
|                  | [Enable Webserver] <i>E W E</i> .....                        | 86         |
|                  | [Reset OptWeb Passwd] <i>r W P D</i> .....                   | 87         |
|                  | [Com. Module cmd.] <i>C π d ∃</i> .....                      | 88         |
|                  | [Com. Module Ref Freq] <i>L F r ∃</i> .....                  | 89         |
|                  | [Ethernet Timeout] <i>t t α b</i> .....                      | 90         |
| 4.2              | Additional Settings .....                                    | 91         |
|                  | FDR Settings .....                                           | 92         |
|                  | RSTP Settings .....                                          | 93         |
|                  | Configuring I/O Scanning .....                               | 95         |
|                  | DNS Settings .....                                           | 96         |
|                  | SNTP Settings .....                                          | 97         |
|                  | SNMP Settings .....                                          | 98         |
| 4.3              | Fast Device Replacement .....                                | 100        |
|                  | Presentation .....                                           | 101        |
|                  | Startup Detailed Behavior .....                              | 102        |
|                  | FDR Operation Behavior .....                                 | 103        |
|                  | Local Configuration .....                                    | 104        |
|                  | Downloaded Configuration .....                               | 105        |
| 4.4              | Communication Profile .....                                  | 108        |
|                  | Definition of a Profile .....                                | 109        |
|                  | Functional Profiles Supported by the Drive .....             | 110        |
|                  | Functional Description .....                                 | 111        |
|                  | CIA402 Operating State Diagram .....                         | 112        |
|                  | Description of Operating States .....                        | 113        |
|                  | Summary .....                                                | 115        |
|                  | Cmd Register <i>C π d</i> .....                              | 116        |
|                  | Stop Commands .....                                          | 117        |
|                  | Assigning Control Word Bits .....                            | 118        |
|                  | [CIA402 State Reg] <i>E t π</i> .....                        | 119        |
|                  | Starting Sequence .....                                      | 120        |
|                  | Sequence for a Drive Powered by the Power Stage Supply ..... | 121        |
|                  | Sequence for a Drive with Separate Control Stage .....       | 122        |
|                  | Sequence for a Drive with Mains Contactor Control .....      | 124        |
| 4.5              | Embedded Webserver .....                                     | 125        |
|                  | Overview .....                                               | 126        |
|                  | Connection to the Webserver .....                            | 127        |
|                  | My Dashboard .....                                           | 129        |
|                  | Display - Drive .....                                        | 130        |
|                  | Setup - My Preference .....                                  | 131        |
| 4.6              | Fieldbus Integration Using Unity Pro (M580) .....            | 132        |
|                  | Introduction .....                                           | 133        |
|                  | EtherNet/IP Configuration .....                              | 134        |
|                  | Configuration of the Master .....                            | 135        |
|                  | DTM Library .....                                            | 136        |
|                  | DTM Browser .....                                            | 137        |
| <b>Chapter 5</b> | <b>Operations</b> .....                                      | <b>139</b> |
| 5.1              | Operating States .....                                       | 140        |
|                  | Configuring Communication Error Response .....               | 140        |

---

|                  |                                                                                          |            |
|------------------|------------------------------------------------------------------------------------------|------------|
| 5.2              | Operating Modes . . . . .                                                                | 142        |
|                  | Configuring the Control Channel . . . . .                                                | 143        |
|                  | Configuration of the Drive for Operation in I/O Profile . . . . .                        | 144        |
|                  | Configuration of the Drive for Operation with CiA 402 Profile in Combined Mode . . . . . | 145        |
|                  | Configuration of the Drive for Operation with CiA 402 Profile in Separate Mode . . . . . | 146        |
| <b>Chapter 6</b> | <b>Diagnostic and Troubleshooting . . . . .</b>                                          | <b>147</b> |
|                  | Fieldbus Status LEDs . . . . .                                                           | 148        |
|                  | Connection for Fieldbus Mode . . . . .                                                   | 150        |
|                  | Fieldbus Functions Test . . . . .                                                        | 151        |
|                  | Control-Signal Diagnostics . . . . .                                                     | 153        |
| <b>Glossary</b>  | . . . . .                                                                                | <b>155</b> |

---



## Important Information

### NOTICE

Read these instructions carefully, and look at the equipment to become familiar with the device before trying to install, operate, service, or maintain it. The following special messages may appear throughout this documentation or on the equipment to warn of potential hazards or to call attention to information that clarifies or simplifies a procedure.



The addition of this symbol to a “Danger” or “Warning” safety label indicates that an electrical hazard exists which will result in personal injury if the instructions are not followed.



This is the safety alert symbol. It is used to alert you to potential personal injury hazards. Obey all safety messages that follow this symbol to avoid possible injury or death.

### **DANGER**

**DANGER** indicates a hazardous situation which, if not avoided, **will result in** death or serious injury.

### **WARNING**

**WARNING** indicates a hazardous situation which, if not avoided, **could result in** death or serious injury.

### **CAUTION**

**CAUTION** indicates a hazardous situation which, if not avoided, **could result in** minor or moderate injury.

### **NOTICE**

**NOTICE** is used to address practices not related to physical injury.

### PLEASE NOTE

Electrical equipment should be installed, operated, serviced, and maintained only by qualified personnel. No responsibility is assumed by Schneider Electric for any consequences arising out of the use of this material.

A qualified person is one who has skills and knowledge related to the construction and operation of electrical equipment and its installation, and has received safety training to recognize and avoid the hazards involved.

### Qualification Of Personnel

Only appropriately trained persons who are familiar with and understand the contents of this manual and all other pertinent product documentation are authorized to work on and with this product. In addition, these persons must have received safety training to recognize and avoid hazards involved. These persons must have sufficient technical training, knowledge and experience and be able to foresee and detect potential hazards that may be caused by using the product, by changing the settings and by the mechanical, electrical and electronic equipment of the entire system in which the product is used. All persons working on and with the product must be fully familiar with all applicable standards, directives, and accident prevention regulations when performing such work.

## Intended Use

This product is a drive for three-phase synchronous and asynchronous motors and intended for industrial use according to this manual. The product may only be used in compliance with all applicable safety standard and local regulations and directives, the specified requirements and the technical data. The product must be installed outside the hazardous ATEX zone. Prior to using the product, you must perform a risk assessment in view of the planned application. Based on the results, the appropriate safety measures must be implemented. Since the product is used as a component in an entire system, you must ensure the safety of persons by means of the design of this entire system (for example, machine design). Any use other than the use explicitly permitted is prohibited and can result in hazards. Electrical equipment should be installed, operated, serviced, and maintained only by qualified personnel.

## Product Related Information

**Read and understand these instructions before performing any procedure with this drive.**

### **DANGER**

#### **HAZARD OF ELECTRIC SHOCK, EXPLOSION OR ARC FLASH**

- Only appropriately trained persons who are familiar with and understand the contents of this manual and all other pertinent product documentation and who have received safety training to recognize and avoid hazards involved are authorized to work on and with this drive system. Installation, adjustment, repair and maintenance must be performed by qualified personnel.
- The system integrator is responsible for compliance with all local and national electrical code requirements as well as all other applicable regulations with respect to grounding of all equipment.
- Many components of the product, including the printed circuit boards, operate with mains voltage. Do not touch. Use only electrically insulated tools.
- Do not touch unshielded components or terminals with voltage present.
- Motors can generate voltage when the shaft is rotated. Prior to performing any type of work on the drive system, block the motor shaft to prevent rotation.
- AC voltage can couple voltage to unused conductors in the motor cable. Insulate both ends of unused conductors of the motor cable.
- Do not short across the DC bus terminals or the DC bus capacitors or the braking resistor terminals.
- Before performing work on the drive system:
  - Disconnect all power, including external control power that may be present.
  - Place a **Do Not Turn On** label on all power switches.
  - Lock all power switches in the open position.
  - Wait 15 minutes to allow the DC bus capacitors to discharge. The DC bus LED is not an indicator of the absence of DC bus voltage that can exceed 800 Vdc. Measure the voltage on the DC bus between the DC bus terminals (PA+, PC/-) using a properly rated voltmeter to verify that the voltage is <42 Vdc
  - If the DC bus capacitors do not discharge properly, contact your local Schneider Electric representative. Do not repair or operate the product.
- Install and close all covers before applying voltage.

**Failure to follow these instructions will result in death or serious injury.**

Drive systems may perform unexpected movements because of incorrect wiring, incorrect settings, incorrect data or other errors.

### **WARNING**

#### **UNANTICIPATED EQUIPMENT OPERATION**

- Carefully install the wiring in accordance with the EMC requirements.
- Do not operate the product with unknown or unsuitable settings or data.
- Perform a comprehensive commissioning test.

**Failure to follow these instructions can result in death, serious injury, or equipment damage.**

Damaged products or accessories may cause electric shock or unanticipated equipment operation.

## DANGER

### ELECTRIC SHOCK OR UNANTICIPATED EQUIPMENT OPERATION

Do not use damaged products or accessories.

**Failure to follow these instructions will result in death or serious injury.**

Contact your local Schneider Electric sales office if you detect any damage whatsoever.

## WARNING

### LOSS OF CONTROL

- The designer of any control scheme must consider the potential failure modes of control paths and, for critical control functions, provide a means to achieve a safe state during and after a path failure. Examples of critical control functions are emergency stop, overtravel stop, power outage and restart.
- Separate or redundant control paths must be provided for critical control functions.
- System control paths may include communication links. Consideration must be given to the implications of unanticipated transmission delays or failures of the link.
- Observe all accident prevention regulations and local safety guidelines (1).
- Each implementation of the product must be individually and thoroughly tested for proper operation before being placed into service.

**Failure to follow these instructions can result in death, serious injury, or equipment damage.**

(1) For USA: Additional information, refer to NEMA ICS 1.1 (latest edition), Safety Guidelines for the Application, Installation, and Maintenance of Solid State Control and to NEMA ICS 7.1 (latest edition), Safety Standards for Construction and Guide for Selection, Installation and Operation of Adjustable-Speed Drive Systems.

## *NOTICE*

### DESTRUCTION DUE TO INCORRECT MAINS VOLTAGE

Before switching on and configuring the product, verify that it is approved for the mains voltage

**Failure to follow these instructions can result in equipment damage.**

The temperature of the products described in this manual may exceed 80 °C (176 °F) during operation.

## WARNING

### HOT SURFACES

- Ensure that any contact with hot surfaces is avoided.
- Do not allow flammable or heat-sensitive parts in the immediate vicinity of hot surfaces.
- Verify that the product has sufficiently cooled down before handling it.
- Verify that the heat dissipation is sufficient by performing a test run under maximum load conditions.

**Failure to follow these instructions can result in death, serious injury, or equipment damage.**

The product is not approved for use in hazardous areas (explosive atmospheres).

## WARNING

### EXPLOSION HAZARD

Only use this device outside of hazardous areas (explosive atmospheres).

**Failure to follow these instructions can result in death, serious injury, or equipment damage.**

Machines, controllers, and related equipment are usually integrated into networks. Unauthorized persons and malware may gain access to the machine as well as to other devices on the network/fieldbus of the machine and connected networks via insufficiently secure access to software and networks.

---

## **WARNING**

### **UNAUTHORIZED ACCESS TO THE MACHINE VIA SOFTWARE AND NETWORKS**

- In your hazard and risk analysis, consider all hazards that result from access to and operation on the network/fieldbus and develop an appropriate cyber security concept.
- Verify that the hardware infrastructure and the software infrastructure into which the machine is integrated as well as all organizational measures and rules covering access to this infrastructure consider the results of the hazard and risk analysis and are implemented according to best practices and standards covering IT security and cyber security (such as: ISO/IEC 27000 series, Common Criteria for Information Technology Security Evaluation, ISO/ IEC 15408, IEC 62351, ISA/IEC 62443, NIST Cybersecurity Framework, Information Security Forum - Standard of Good Practice for Information Security).
- Verify the effectiveness of your IT security and cyber security systems using appropriate, proven methods.

**Failure to follow these instructions can result in death, serious injury, or equipment damage.**

---

# About the Book

---



## At a Glance

### Document Scope

The purpose of this document is to:

- Show you how to install the Ethernet fieldbus on your drive.
- Show you how to configure drive to use Ethernet for monitoring and control.
- Provide examples of setup using Unity

**NOTE:** Read and understand this document and all related documents (see below) before installing, operating, or maintaining your drive.

### Validity Note

This documentation is valid for the Altivar Process drives.

The technical characteristics of the devices described in this document also appear online. To access this information online:

| Step | Action                                                                                                                                                                                                                                                                                 |
|------|----------------------------------------------------------------------------------------------------------------------------------------------------------------------------------------------------------------------------------------------------------------------------------------|
| 1    | Go to the Schneider Electric home page <a href="http://www.schneider-electric.com">www.schneider-electric.com</a> .                                                                                                                                                                    |
| 2    | In the <b>Search</b> box type the reference of a product or the name of a product range. <ul style="list-style-type: none"><li>• Do not include blank spaces in the reference or product range.</li><li>• To get information on grouping similar modules, use asterisks (*).</li></ul> |
| 3    | If you entered a reference, go to the <b>Product Datasheets</b> search results and click on the reference that interests you.<br>If you entered the name of a product range, go to the <b>Product Ranges</b> search results and click on the product range that interests you.         |
| 4    | If more than one reference appears in the <b>Products</b> search results, click on the reference that interests you.                                                                                                                                                                   |
| 5    | Depending on the size of your screen, you may need to scroll down to see the data sheet.                                                                                                                                                                                               |
| 6    | To save or print a data sheet as a .pdf file, click <b>Download XXX product datasheet</b> .                                                                                                                                                                                            |

The characteristics that are presented in this manual should be the same as those characteristics that appear online. In line with our policy of constant improvement, we may revise content over time to improve clarity and accuracy. If you see a difference between the manual and online information, use the online information as your reference.

## Related Documents

Use your tablet or your PC to quickly access detailed and comprehensive information on all our products on [www.schneider-electric.com](http://www.schneider-electric.com)

The internet site provides the information you need for products and solutions

- The whole catalog for detailed characteristics and selection guides
- The CAD files to help design your installation, available in over 20 different file formats
- All software and firmware to maintain your installation up to date
- A large quantity of White Papers, Environment documents, Application solutions, Specifications... to gain a better understanding of our electrical systems and equipment or automation
- And finally all the User Guides related to your drive, listed below:

| Title of Documentation                                            | Reference Number                                                                                                                                                                                                     |
|-------------------------------------------------------------------|----------------------------------------------------------------------------------------------------------------------------------------------------------------------------------------------------------------------|
| Altivar Process ATV600 Getting Started                            | <a href="#">EAV63253</a> (English), <a href="#">EAV63254</a> (French), <a href="#">EAV63255</a> (German), <a href="#">EAV63256</a> (Spanish), <a href="#">EAV64310</a> (Italian), <a href="#">EAV64298</a> (Chinese) |
| Altivar Process ATV600 Getting Started Annex (SCCR)               | <a href="#">EAV64300</a> (English)                                                                                                                                                                                   |
| Altivar Process ATV630, ATV650 Installation Manual                | <a href="#">EAV64301</a> (English), <a href="#">EAV64302</a> (French), <a href="#">EAV64306</a> (German), <a href="#">EAV64307</a> (Spanish), <a href="#">EAV63257</a> (Italian), <a href="#">EAV64317</a> (Chinese) |
| Altivar Process ATV630, ATV650 Programming Manual                 | <a href="#">EAV64318</a> (English), <a href="#">EAV64320</a> (French), <a href="#">EAV64321</a> (German), <a href="#">EAV64322</a> (Spanish), <a href="#">EAV64323</a> (Italian), <a href="#">EAV64324</a> (Chinese) |
| Altivar Process ATV600 Modbus Serial Link Manual (Embedded)       | <a href="#">EAV64325</a> (English)                                                                                                                                                                                   |
| Altivar Process ATV600 Ethernet Manual (Embedded)                 | <a href="#">EAV64327</a> (English)                                                                                                                                                                                   |
| Altivar Process ATV600 Ethernet IP - Modbus TCP Manual (VW3A3720) | <a href="#">EAV64328</a> (English)                                                                                                                                                                                   |
| Altivar Process ATV600 PROFIBUS DP manual (VW3A3607)              | <a href="#">EAV64329</a> (English)                                                                                                                                                                                   |
| Altivar Process ATV600 DeviceNet manual (VW3A3609)                | <a href="#">EAV64330</a> (English)                                                                                                                                                                                   |
| Altivar Process ATV600 PROFINET manual (VW3A3627)                 | <a href="#">EAV64331</a> (English)                                                                                                                                                                                   |
| Altivar Process ATV600 CANopen Manual (VW3A3608, 618, 628)        | <a href="#">EAV64333</a> (English)                                                                                                                                                                                   |
| Altivar Process ATV600 Communication Parameters                   | <a href="#">EAV64332</a> (English)                                                                                                                                                                                   |
| Altivar Process ATV600 Safety Function manual                     | <a href="#">EAV64334</a> (English)                                                                                                                                                                                   |

You can download these technical publications and other technical information from our website at <http://download.schneider-electric.com>

## Terminology

The technical terms, terminology, and the corresponding descriptions in this manual normally use the terms or definitions in the relevant standards.

In the area of drive systems this includes, but is not limited to, terms such as **error**, **error message**, **failure**, **fault**, **fault reset**, **protection**, **safe state**, **safety function**, **warning**, **warning message**, and so on.

Among others, these standards include:

- IEC 61800 series: Adjustable speed electrical power drive systems
- IEC 61508 Ed.2 series: Functional safety of electrical/electronic/programmable electronic safety-related
- EN 954-1 Safety of machinery - Safety related parts of control systems
- EN ISO 13849-1 & 2 Safety of machinery - Safety related parts of control systems.
- IEC 61158 series: Industrial communication networks - Fieldbus specifications
- IEC 61784 series: Industrial communication networks - Profiles
- IEC 60204-1: Safety of machinery - Electrical equipment of machines – Part 1: General requirements

In addition, the term **zone of operation** is used in conjunction with the description of specific hazards, and is defined as it is for a **hazard zone** or **danger zone** in the EC Machinery Directive (2006/42/EC) and in ISO 12100-1.

Also see the glossary at the end of this manual.

---

# Chapter 1

## Presentation

---

### What Is in This Chapter?

This chapter contains the following topics:

| Topic             | Page |
|-------------------|------|
| Hardware Overview | 14   |
| Software Overview | 15   |

## Hardware Overview

### General

The VW3A3720 is an Ethernet module that can be used in the following two industrial communication protocols:

- Modbus TCP
- EtherNet/IP

In addition, of the communication services provided by each protocol, the Ethernet module provides a set of services at the Ethernet and TCP/IP level. The adapter offers an embedded Web server (in six languages) which offers comfortable displaying and commissioning functions directly from a standard web browser.

The figure shows the location of the dual ports Ethernet module.



## Software Overview

### Simplified TCP/IP Model

The table provides the basic overview to the simplified TCP/IP model

|                    |                        |
|--------------------|------------------------|
| <b>Application</b> | Modbus TCP-EtherNet/IP |
| <b>Transport</b>   | TCP / UDP              |
| <b>Network</b>     | IP                     |
| <b>Link</b>        | Ethernet               |

### Modbus TCP-EtherNet/IP Features Overview

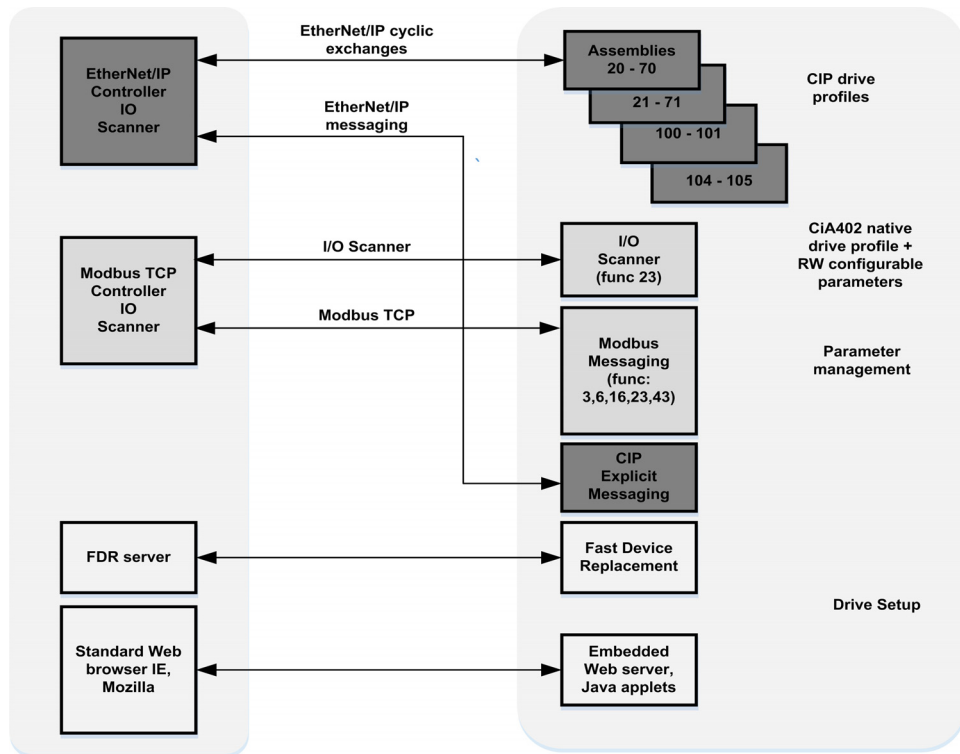



---

# Chapter 2

## Basics

---

### What Is in This Chapter?

This chapter contains the following sections:

| Section | Topic                | Page |
|---------|----------------------|------|
| 2.1     | Introduction         | 18   |
| 2.2     | Modbus TCP Features  | 23   |
| 2.3     | Ethernet IP Features | 28   |
| 2.4     | CIP Object           | 35   |

## Section 2.1

### Introduction

---

#### What Is in This Section?

This section contains the following topics:

| Topic                                       | Page |
|---------------------------------------------|------|
| Introduction                                | 19   |
| Network Layer Supported Functions/Protocols | 20   |
| TCP and UDP Protocol                        | 21   |

## Introduction

### Modbus TCP

The Modbus application layer is standard. Many of the manufacturers are already implementing this protocol. Many have already developed a Modbus TCP/IP connection and numerous products are currently available. With the simplicity of its protocol and the fast Ethernet throughput data rate of 100 Mbit/s, Modbus TCP/IP achieves excellent performance.

### EtherNet/IP

EtherNet/IP is a fieldbus based on TCP and UDP. EtherNet/IP extends Ethernet by an advanced industrial protocol (CIP, Common Industrial Protocol) as an application layer for automation applications in this way, Ethernet suites for industrial control. Products from different manufacturers can be networked without the need for special interface adaptation.

### TCP/IP and Ethernet Features

The product supports the following functions via:

- Manual IP address assignment
- Automatic IP address assignment via BOOTP or DHCP
- Automatic configuration data via FDR
- Commissioning via DTM-based commissioning software
- Diagnostics and configuration via integrated Web server
- Support of LLDP (Link Layer Discovery Protocol)
- Support of RSTP (Rapid Spanning Tree Protocol)
- Support of SNMP (Simple Network Management Protocol)
- Support of SMTP (Simple Mail Transfer Protocol)
- Support of DNS (Domain Name System)
- Support of IPV6 for DPWS (Devices Profile for Web Services)
- Handling of QoS (Quality of Service)

### Web Server

The standard webserver (in six languages) provides access to pages such as:

- My dashboard
- Display
- Diagnostics
- Drive
- Setup

## Network Layer Supported Functions/Protocols

### ARP Protocol

The ARP (Address resolution protocol) is a protocol used to map network addresses (IP) to hardware addresses (MAC).

The protocol operates below the network layer as a part of the OSI link layer, and is used when IP is used over Ethernet. A host, wishing to obtain a physical address, broadcasts an ARP request onto the TCP/IP network. A unique IP address is assigned to the host, and is sent to its hardware address.

### ICPM Protocol

The VW3A3720 Ethernet module manages the ICMP protocol.

- ICMP client: not supported
- ICMP server: the managed requests are the following:

| Type | Description             |
|------|-------------------------|
| 0    | Echo reply (ping)       |
| 3    | Destination unreachable |
| 4    | Sources quench          |
| 5    | Redirect                |
| 6    | Alternate host address  |
| 8    | Echo request (ping)     |
| 9    | Router advertisement    |
| 10   | Router solicitation     |
| 11   | Time exceeded           |
| 12   | Parameter problem       |
| 13   | Time stamp request      |
| 14   | Time stamp reply        |
| 15   | Information request     |
| 16   | Information reply       |
| 17   | Address mask request    |
| 18   | Address mask reply      |

### IP Protocol

The Ethernet adapter implements the IPV4 and IPV6 (for DPWS) protocols.

### SNMP Services

The Ethernet adapter accepts the community name “private” for writing and the community name “public” for Reading.

### MIB

| Objects       | Description                                          | Access     | Default Value                              |
|---------------|------------------------------------------------------|------------|--------------------------------------------|
| SysDescr      | Text description of the product                      | Read only  | Schneider Electric Altivar Ethernet TCP/IP |
| SysObjectID   | Points in the private MIB on the product part number | Read only  | 1.3.6.1.4.1.3833.1.100.4.1                 |
| SysUpTime     | Time elapsed since the last power-up                 | Read only  | Managed by the option                      |
| SysContact    | Information allowing to contact the node manager     | Read/write | " "                                        |
| SysName       | Node administrative name                             | Read/write | "" or FDR device name if configured        |
| SysLocation   | Physical location of the product                     | Read/write | " "                                        |
| SystemService | Indicates the service type offered by the product.   | Read only  | 72                                         |

## TCP and UDP Protocol

### Connections

The Ethernet adapter supports up to 32 concurrent TCP/IP and/or TCP/UDP connection.

### BOOTP and DHCP Protocol

The Ethernet adapter can use BOOTP and DHCP protocols.

The BOOTP frame is the same: only the OP field is different.

The following table describes the DHCP frame format:

|                     |                |                 |               |
|---------------------|----------------|-----------------|---------------|
| OP (1 byte)         | HTYPE (1 byte) | HLEN (1 byte)   | HOPS (1 byte) |
| XID (4 bytes)       |                |                 |               |
| SECS (2 bytes)      |                | FLAGS (2 bytes) |               |
| CIADDR (4 bytes)    |                |                 |               |
| YIADDR (4 bytes)    |                |                 |               |
| SIADDR (4 bytes)    |                |                 |               |
| GIADDR (4 bytes)    |                |                 |               |
| CHADDR (16 bytes)   |                |                 |               |
| SNAME (64 bytes)    |                |                 |               |
| FILE (128 bytes)    |                |                 |               |
| OPTIONS (312 bytes) |                |                 |               |

DHCP frame fields are described as follows:

| Field   | Description                                                                                                   |
|---------|---------------------------------------------------------------------------------------------------------------|
| op      | Message type DHCP request / DHCP reply                                                                        |
| htype   | Address hardware type                                                                                         |
| hlen    | Hardware address length                                                                                       |
| hops    | Used by relay agent                                                                                           |
| xid     | Transaction identifier, random number chosen by the client allowing to associate the request and the response |
| secs    | Time in seconds since the beginning of the transaction                                                        |
| flags   | First bit used for the broadcast reply flag                                                                   |
| ciaddr  | Client IP address, only used if the client can respond to ARP request                                         |
| yiaddr  | Client IP address, "your" IP address proposed by the server                                                   |
| siaddr  | IP address of the server                                                                                      |
| giaddr  | Gateway IP address, used when a relay agent needs to be crossed                                               |
| sname   | Server name                                                                                                   |
| file    | Location of boot file                                                                                         |
| options | Optional parameters with DHCP extensions                                                                      |

## DHCP Message

The DHCP protocol uses 8 different types of message during the IP assigning process.

The following table describes the 8 messages:

| Message  | Description                                                            |
|----------|------------------------------------------------------------------------|
| DISCOVER | The client tries to discover the DHCP server using a broadcast         |
| OFFER    | The server proposes a configuration                                    |
| REQUEST  | The client chooses a DHCP server and declines other offers             |
| ACK      | The chosen server assigns the IP configuration                         |
| NAK      | The server rejects the client request                                  |
| DECLINE  | The client declines the assigned IP configuration                      |
| RELEASE  | The client releases its IP address before the end of the lease         |
| INFORM   | The client asks for network information (it already has an IP address) |

## Operating Modes

The choice between DHCP, BOOTP, and fixed configuration is made through one parameter:

- Fixed: the Ethernet adapter uses the address stored in parameter.
- BOOTP: the Ethernet adapter receives the addresses from BOOTP server.
- DHCP: if the device name [XXX] is valid, the Ethernet adapter receives the addresses from the DHCP server.

---

## Section 2.2

### Modbus TCP Features

---

#### What Is in This Section?

This section contains the following topics:

| Topic                               | Page |
|-------------------------------------|------|
| Modbus TCP Frames                   | 24   |
| Modbus TCP Servers                  | 25   |
| Supported Modbus TCP Functions      | 26   |
| Application Profile with Modbus TCP | 27   |

## Modbus TCP Frames

### TCP Telegrams

Modbus TCP telegrams are not only Modbus standard requests and responses encapsulated in TCP frames.

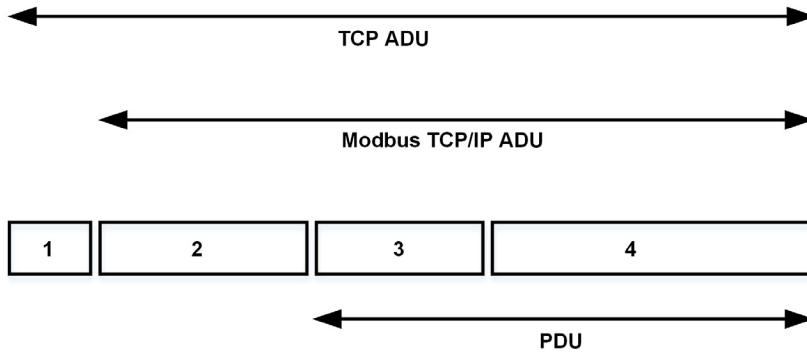

- 1 TCP header
- 2 MBPA: Modbus application protocol header
- 3 ADU: Application data unit
- 4 PDU: Protocol data unit (The Modbus message itself)

### MBAP Header Structure

| Fields                 | Length  | Description                                                                   | Client                              | Server                                           |
|------------------------|---------|-------------------------------------------------------------------------------|-------------------------------------|--------------------------------------------------|
| Transaction identifier | 2 bytes | Identification of a Modbus request / response transaction                     | Initialized by the client           | Recopied by the server from the received request |
| Protocol identifier    | 2 bytes | 0= Modbus protocol                                                            | Initialized by the client           | Recopied by the server from the received request |
| Length                 | 2 bytes | Number of following bytes                                                     | Initialized by the client (request) | Initialized by the server (response)             |
| Unit identifier        | 1 byte  | Identification of a remote slave connected on a serial line or on other buses | Initialized by the client           | Recopied by the server from the received request |

## Modbus TCP Servers

### Overview

| Unit ID | Modbus TCP server    | Accessible parameters                                   |
|---------|----------------------|---------------------------------------------------------|
| 0/248   | Variable speed drive | See the file related to drive communication parameters. |
| 255     | Drive I/O scanner    | See I/O scanner setting ( <a href="#">see page 26</a> ) |

## Supported Modbus TCP Functions

### Modbus TCP Services

The Modbus TCP option supports the following services:

| Function Name                                         | Code  |                  | Description                                                   | Remarks                                    |
|-------------------------------------------------------|-------|------------------|---------------------------------------------------------------|--------------------------------------------|
|                                                       | Dec   | Hex              |                                                               |                                            |
| Read holding registers                                | 03    | 03 hex           | Read N output words                                           | Max PDU length: 63 words                   |
| Write 1 output word (Unit ID 0-248 only)              | 06    | 06 hex           | Write 1 output word                                           |                                            |
| Write multiple registers                              | 16    | 10 hex           | Write N output word                                           | Max PDU length: 63 words                   |
| Read/write multiple registers (Unit ID 0-248 and 255) | 23    | 17 hex           | Read/write multiple registers                                 | Max PDU length: 32 words (W), 32 words (R) |
| (Subfunction)<br>Read device identification           | 43/14 | 2B hex<br>0E hex | Encapsulated interface transport / read device identification | See the table below                        |

### Identification

| Id     | Value              | Comment                      |
|--------|--------------------|------------------------------|
| 00 hex | Schneider electric | Device manufacturer          |
| 01 hex | ATVXXX             | Drive commercial part number |
| 02 hex | 0101               | Drive version                |
| 04 hex | -                  | -                            |
| 05 hex | -                  | -                            |
| 06 hex | Customized Name    | Device name                  |

### I/O Scanning Service

The I/O scanning service is used to exchange periodic I/O data between:

- A controller or PLC (I/O scanner).
- Devices (I/O scanning servers).

This exchange is performed by implicit requests, thus avoiding the need to program the controller (PLC).

The I/O scanner periodically generates the read/write multiple registers (23 = 17 hex) request. The I/O scanning service operates if it has been enabled in the PLC and in the drive. The drive parameters assigned to I/O scanning have been selected by default. This assignment can be modified by configuration.

When the I/O scanning service has been enabled in the drive:

- A TCP connection is assigned to it.
- The parameters assigned in the periodic variables are exchanged cyclically between the Ethernet adapter and the drive.
- The parameters assigned to the periodic output variables are reserved for I/O scanning. They cannot be written by other Modbus services, even if the I/O scanner is not sending its periodic output variables.

### I/O Scanner Setting

The communication scanner is managed through the DTM-based PC software.

| Channel         | Factory Setting |
|-----------------|-----------------|
| Output 1        | <i>C P d</i>    |
| Output 2        | <i>L F r d</i>  |
| Output 3        | 0               |
| Up to output 32 | 0               |
| Input 1         | <i>E t A</i>    |
| Input 2         | <i>r F r d</i>  |
| Input 3         | 0               |
| Up to Input 32  | 0               |

---

## Application Profile with Modbus TCP

### Description

The profiles managed with the drive when it is controlled through Modbus TCP are:

- Native profile (CiA402 - IEC 61800-7),
- I/O profile.

For details, refer to CiA@402 - IEC61800-7 functional profile

## Section 2.3

### Ethernet IP Features

---

#### What Is in This Section?

This section contains the following topics:

| Topic                                   | Page |
|-----------------------------------------|------|
| EtherNet/IP                             | 29   |
| Cyclical Exchanges (Implicit Exchanges) | 30   |
| Messaging (Explicit Exchanges)          | 33   |
| Timeout Monitoring                      | 34   |

## EtherNet/IP

### EtherNet/IP Fieldbus Module Features Overview

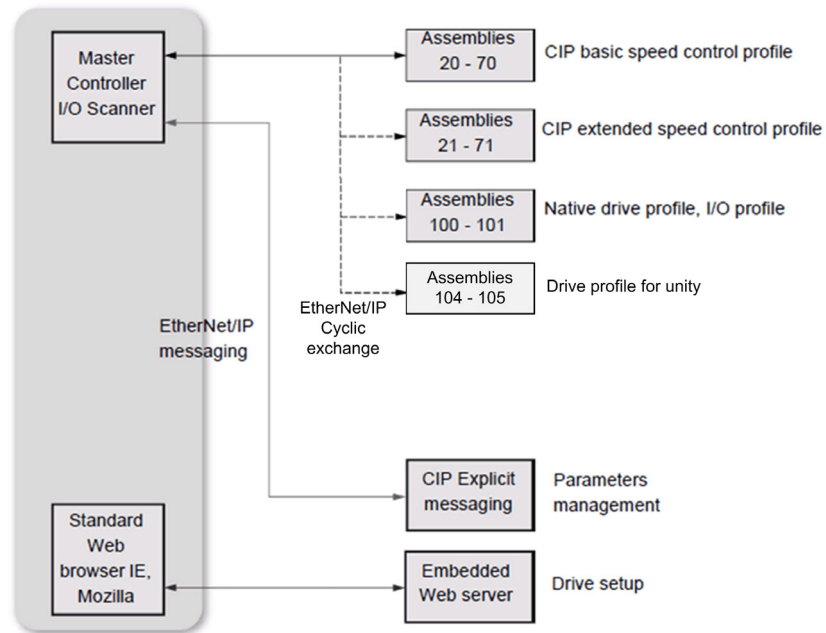

The Ethernet adapter, is compliant with the ODVA drive profile. It supports the following profiles:

- CIP basic speed control
- CIP extended speed control
- Drive native profile (IEC 61800-7 CiA402) and I/O profile only for assembly 100, 101, 104 and 105. In addition to these cyclic exchanges, the adapter also supports explicit messaging.
- CIP energy objects

## Cyclical Exchanges (Implicit Exchanges)

### Overview

This part gives a description of the assembly sets and how to configure them.

### Principle of Control Configuration

By the configuration of the control, it is possible to decide from which channel the drive receives its commands and reference frequency, either permanently or depending on a switching command. Numerous configurations are possible. For more information, refer to the programming manual and communication parameters manual. The following configurations are some of the available possibilities. The selection of the assembly set is made with the DTM.

### Control with Communication Scanner

If the assemblies selected are 100 and 101, the drive is controlled according to its native profile CiA402.- IEC-61800-7.

By configuring the communication scanner, it is possible to assign any relevant parameter of the drive to the 32 input and 32 output variables of the assemblies. This is available through the DTM interface.

### Control According to ODVA AC Drive Profile

The ODVA AC drive profile is activated when one of the following assemblies is selected:

- 20: Basic speed control output, size 2 words / 4 bytes
- 21: Extended speed control output, size 2 words / 4 bytes
- 70: Basic speed control input, size 2 words / 4 bytes
- 71: Extended speed control input, size 2 words / 4 bytes

The Ethernet adapter translates the commands, behavior, and display information from of ODVA profile (on the network) to the CiA402 profile (in the drive).

### CIP Basic Speed Control (Assemblies 20 and 70)

- Assembly 20: CIP basic speed control output

The following table describes the assembly mapping:

| Word Number | Definition             |
|-------------|------------------------|
| 0           | CIP basic command word |
| 1           | Speed reference (rpm)  |

The following table describes the CIP basic command word:

| Bit 7                                                                  | Bit 6    | Bit 5    | Bit 4    | Bit 3    | Bit 2                                                         | Bit 1    | Bit 0                                           |
|------------------------------------------------------------------------|----------|----------|----------|----------|---------------------------------------------------------------|----------|-------------------------------------------------|
| Not used                                                               | Not used | Not used | Not used | Not used | Fault reset <sup>(1)</sup><br>0: No command<br>1: Fault reset | Not used | Run forward <sup>(2)</sup><br>0: Stop<br>1: Run |
| <sup>(1)</sup> Active on rising edge<br><sup>(2)</sup> Active on level |          |          |          |          |                                                               |          |                                                 |

| Bit 15   | Bit 14   | Bit 13   | Bit 12   | Bit 11   | Bit 10   | Bit 9    | Bit 8    |
|----------|----------|----------|----------|----------|----------|----------|----------|
| Not used | Not used | Not used | Not used | Not used | Not used | Not used | Not used |

- Assembly 70: CIP basic speed control input

The following table describes the assembly mapping:

| Word Number | Definition            |
|-------------|-----------------------|
| 0           | CIP basic status word |
| 1           | Actual speed (rpm)    |

The following table describes the CIP basic command word:

| Bit 7    | Bit 6    | Bit 5    | Bit 4    | Bit 3    | Bit 2                               | Bit 1    | Bit 0                                                |
|----------|----------|----------|----------|----------|-------------------------------------|----------|------------------------------------------------------|
| Not used | Not used | Not used | Not used | Not used | Running<br>0: Stopped<br>1: Running | Not used | Operating state<br>fault<br>0: Inactive<br>1: Active |

| Bit 15   | Bit 14   | Bit 13   | Bit 12   | Bit 11   | Bit 10   | Bit 9    | Bit 8    |
|----------|----------|----------|----------|----------|----------|----------|----------|
| Not used | Not used | Not used | Not used | Not used | Not used | Not used | Not used |

### CIP Extended Speed Control (Assemblies 21 and 71)

- Assembly 21: CIP extended speed control output

The following table describes the assembly mapping:

| Word Number | Definition                |
|-------------|---------------------------|
| 0           | CIP extended command word |
| 1           | Speed reference (rpm)     |

The following table describes the CIP extended command word:

| Bit 7    | Bit 6                                                                          | Bit 5                                                                         | Bit 4    | Bit 3    | Bit 2                                                         | Bit 1                                                                                               | Bit 0 |
|----------|--------------------------------------------------------------------------------|-------------------------------------------------------------------------------|----------|----------|---------------------------------------------------------------|-----------------------------------------------------------------------------------------------------|-------|
| Not used | Network<br>setpoint<br>0: Setpoint<br>by terminal<br>1: Setpoint<br>by network | Network<br>command<br>0: Setpoint<br>by terminal<br>1: Setpoint<br>by network | Not used | Not used | Fault reset <sup>(1)</sup><br>0: No command<br>1: Fault reset | Run forward / reverse<br>00: Quick stop<br>01: Run forward<br>10: Run reverse<br>11: Freewheel stop |       |

<sup>(1)</sup> Active on rising edge

| Bit 15   | Bit 14   | Bit 13   | Bit 12   | Bit 11   | Bit 10   | Bit 9    | Bit 8    |
|----------|----------|----------|----------|----------|----------|----------|----------|
| Not used | Not used | Not used | Not used | Not used | Not used | Not used | Not used |

**Network Setpoint and Network Address Management**

The assembly 21 uses the command and reference frequency switching functions of the drive. The Ethernet adapter, when configured with the assembly 21, links the bit 5 and the bit 6 to C312 and C313 respectively.

To operate correctly, command settings of the drive must be as follows or an **[Fieldbus Error] E P F 2** is triggered.

| Menu                                                                          | Parameter                                                                                                                                                                                                                                        | Settings                                                                                                                                                                                                               |
|-------------------------------------------------------------------------------|--------------------------------------------------------------------------------------------------------------------------------------------------------------------------------------------------------------------------------------------------|------------------------------------------------------------------------------------------------------------------------------------------------------------------------------------------------------------------------|
| [Complete settings] <i>C S t -</i><br>/[Command and Reference] <i>C r P -</i> | [Control Mode] <i>C H C F</i><br>[Ref Freq 1 Config] <i>F r 1</i><br>[Ref Freq 2 Config] <i>F r 2</i><br>[Cmd Channel 1] <i>C d 1</i><br>[Cmd Channel 2] <i>C d 2</i><br>[Command Switching] <i>C C S</i><br>[Ref Freq 2 switching] <i>r F C</i> | [Separate] <i>S E P</i><br>[Ref. Freq-Com. Module] <i>n E t</i><br>[AI1] <i>A i 1</i> or [AI2] <i>A i 2</i><br>[Com.Module] <i>n E t</i><br>[Terminals] <i>t E r</i><br>[C312] <i>C 3 1 2</i><br>[C313] <i>C 3 1 3</i> |

- Assembly 71: CIP extended speed control input

The following table describes the assembly mapping:

| Word Number | Definition               |
|-------------|--------------------------|
| 0           | CIP extended status word |
| 1           | Actual speed (rpm)       |

The following table describes the CIP extended status word:

| Bit 7                                                            | Bit 6                                                                          | Bit 5                                                                         | Bit 4                             | Bit 3                                                                                              | Bit 2                                     | Bit 1                                             | Bit 0 |
|------------------------------------------------------------------|--------------------------------------------------------------------------------|-------------------------------------------------------------------------------|-----------------------------------|----------------------------------------------------------------------------------------------------|-------------------------------------------|---------------------------------------------------|-------|
| At reference<br>0: Reference not reached<br>1: Reference reached | Setpoint from network<br>0: Setpoint from terminal<br>1: Setpoint from network | Command from network<br>0: Setpoint from terminal<br>1: Setpoint from network | Ready<br>0: Not ready<br>1: Ready | Run forward / reverse<br>00: Stopped<br>01: Running forward<br>10: Running reverse<br>11: Not used | Warning<br>0: No<br>Warning<br>1: Warning | Operating state fault<br>0: Inactive<br>1: Active |       |

| Bit 15   | Bit 14   | Bit 13   | Bit 12   | Bit 11   | Bit 10                                                                                                                                                                                      | Bit 9 | Bit 8 |
|----------|----------|----------|----------|----------|---------------------------------------------------------------------------------------------------------------------------------------------------------------------------------------------|-------|-------|
| Not used | Not used | Not used | Not used | Not used | Bit 8 to 10 are used for the drive state<br>000: Not used<br>001: Startup<br>010: Not ready<br>011: Ready<br>100: Enabled<br>101: Stopping<br>110: Fault stop<br>111: Operating state fault |       |       |

## Messaging (Explicit Exchanges)

### Introduction

Parameters of the drive can be accessed by R/W as CIP objects.

### Altivar Parameters Path

The drive parameters are grouped in classes:

- Each application class has only one instance.
- Each instance groups 200 parameter.
- Each attribute in an instance relates to a parameter.

The first parameter registered in the first application class (class code: 70 hex = 112) has the logical address 3000.

### Example

The following table describes the examples of logical addresses:

| Logical Address | Hexadecimal              | Decimal   |
|-----------------|--------------------------|-----------|
| 3000            | 70 hex / 01 hex / 01 hex | 112/1/1   |
| 3100            | 70 hex / 01 hex / 65 hex | 112/1/101 |
| 3200            | 71 hex / 01 hex / 01 hex | 113/1/1   |
| 64318           | A2 hex / 01 hex / 77 hex | 418/1/119 |

For details, refer to the communication parameters manual.

## Timeout Monitoring

### Description

An EtherNet/IP time-out is triggered if the adapter does not receive any cyclic messages within a predefined time period. This period is managed by the EtherNet/IP controller (not by the drive) and is configured in its module properties box. The duration of the time-out is defined by the RPI (Request packet intervals) and a multiplier.

---

## Section 2.4

### CIP Object

---

#### What Is in This Section?

This section contains the following topics:

| Topic                                                      | Page |
|------------------------------------------------------------|------|
| Supported Object Classes                                   | 36   |
| Identity Object (01 hex)                                   | 37   |
| Message Router Object (02 hex)                             | 40   |
| TCP/IP Interface Object (F5 hex)                           | 41   |
| Ethernet Link Object (F6 hex)                              | 44   |
| Assembly Object (04 hex)                                   | 46   |
| Connection Manager Object (06 hex)                         | 48   |
| Motor Data Object (28 hex)                                 | 50   |
| Control Supervisor Object (29 hex)                         | 51   |
| AC/DC Drive Object (2A hex)                                | 53   |
| Application Object (70 hex to C7 hex) / Explicit Messaging | 56   |
| Base Energy Object (4E hex)                                | 57   |
| Electrical Energy Object (4F hex)                          | 59   |

## Supported Object Classes

### Introduction

Three categories of object classes can be defined:

- CIP device on EtherNet/IP
- AC/DC drive
- VSD specific

These objects are detailed in the following table:

| Object class       | Class ID | Cat. | No. of instances | Effect on behavior interface                              |
|--------------------|----------|------|------------------|-----------------------------------------------------------|
| Identity           | 01 hex   | 1    | 1                | Supports the reset service.                               |
| Message router     | 02 hex   | 1    | 1                | Explicit message connection.                              |
| Ethernet link      | F6 hex   | 1    | 1                | Counter and status information.                           |
| TCP/IP interface   | F5 hex   | 1    | 1                | TCP/IP configuration.                                     |
| Connection manager | 05 hex   | 1    | 1                | –                                                         |
| Motor data         | 28 hex   | 2    | 1                | Defines data for the motor connected to the device.       |
| Control supervisor | 29 hex   | 2    | 1                | Manages drive functions, operational states, and control. |
| AC/DC drive        | 2 A hex  | 2    | 1                | Provides drive configuration.                             |
| Assembly           | 04 hex   | 2    | 12               | Defines I/O data format.                                  |
| Application        | –        | 3    | 1                | Vendor-specific object - drive parameters.                |

## Identity Object (01 hex)

### Overview

The identity object provides identification and status information about the drive.

### Class Code

| Hexadecimal | Decimal |
|-------------|---------|
| 01 hex      | 1       |

### Class Attributes

| Attribute ID | Access | Name                         | Data type | Value | Details                     |
|--------------|--------|------------------------------|-----------|-------|-----------------------------|
| 1            | Get    | Revision                     | UNIT      | X     | Revision index of the class |
| 2            | Get    | Max instances                | UNIT      | 1     | 1 defined instance          |
| 3            | Get    | Number of instances          | UNIT      | 1     | –                           |
| 4            | Get    | Optional attribute list      | UNIT      | 1     | –                           |
| 6            | Get    | Max ID of class attributes   | UNIT      | 7     | –                           |
| 7            | Get    | Max ID of instance attribute | UNIT      | 7     | –                           |

### Instance Attributes

| Attribute ID | Access | Name          | Data type                     | Value        | Details                                                            |
|--------------|--------|---------------|-------------------------------|--------------|--------------------------------------------------------------------|
| 1            | Get    | Vendor ID     | UNIT                          | 243          | –                                                                  |
| 2            | Get    | Device type   | UNIT                          | 00 h<br>02 h | AC/DC drive profile (02h)                                          |
| 3            | Get    | Product code  | UNIT                          | 6152         | 1830 hex                                                           |
| 4            | Get    | Revision      | Struct of:<br>USINT<br>USINT  | x            | Major = high byte of (C 15 u)<br>Minor = low byte of (C 15 u)      |
| 5            | Get    | Status        | WORD                          | –            | See definition in the following table                              |
| 6            | Get    | Serial number | UDINT                         | –            | First byte: 18 hex<br>Second...Fourth byte: last 3 bytes of MAC-ID |
| 7            | Get    | Product name  | Struct of:<br>USINT<br>STRING | –            | ATVxxx                                                             |

### Attribute 5–Status

| Bit    | Definition                                           | How                                                                                                       |
|--------|------------------------------------------------------|-----------------------------------------------------------------------------------------------------------|
| 0      | Owned by master (predefined master/slave connection) | No interface                                                                                              |
| 2      | Configured                                           | If any of the product (option + drive) NVS attributes has changed from their default (out of box values). |
| 4 - 7  | Extended device status: See below                    | –                                                                                                         |
| 8      | Minor recoverable Fault                              | No minor recoverable fault.                                                                               |
| 9      | Minor unrecoverable Fault                            | No minor unrecoverable fault.                                                                             |
| 10     | Major recoverable Fault                              | [Fieldbus Com Interrupt] C n F detected error or CIP connection timeout or Ethernet network overload.     |
| 11     | Major unrecoverable Fault                            | , L F detected error, EEPROM failed, OB hardware detected error.                                          |
| Others | Reserved 0                                           | –                                                                                                         |

**Bit 4-7 Definition**

| Bit 4-7               | Definition                                                | How                                      |
|-----------------------|-----------------------------------------------------------|------------------------------------------|
| 0 0 0 0               | Self-testing or unknown                                   | Not used                                 |
| 0 0 0 1               | Firmware update in progress                               | Not used                                 |
| 0 0 1 0               | At least on faulted I/O connection                        | –                                        |
| 0 0 1 1               | No I/O connections established                            | –                                        |
| 0 1 0 0               | Non-volatile configuration bad                            | Non-volatile memory detected error in OB |
| 0 1 0 1               | Major fault - either bit 10 or 11 is true                 | Bit 10 or 11 is true                     |
| 0 1 1 0               | At least one I/O connection in run mode                   | –                                        |
| 0 1 1 1               | At least one I/O connection established, all in idle mode | –                                        |
| 1 0 0 0<br>1 0 0 1    | Reserved, shall be 0                                      | –                                        |
| 1 0 1 0 to<br>1 1 1 1 | Vendor specific                                           | –                                        |

**Supported Class Services**

| Service code | Service name         | Description         |
|--------------|----------------------|---------------------|
| 01 hex       | Get_Attribute_All    | Read all attributes |
| 0E hex       | Get_Attribute_Single | Read one attribute  |

**Supported Instance Services**

| Service code | Service name         | Description                    |
|--------------|----------------------|--------------------------------|
| 01 hex       | Get_Attribute_All    | Read all attributes            |
| 0E hex       | Get_Attribute_Single | Read one attribute             |
| 10 hex       | Set_Attribute_Single | Write one attribute            |
| 05 hex       | Reset                | Perform the reset of the drive |

State Diagram for the Identity Object

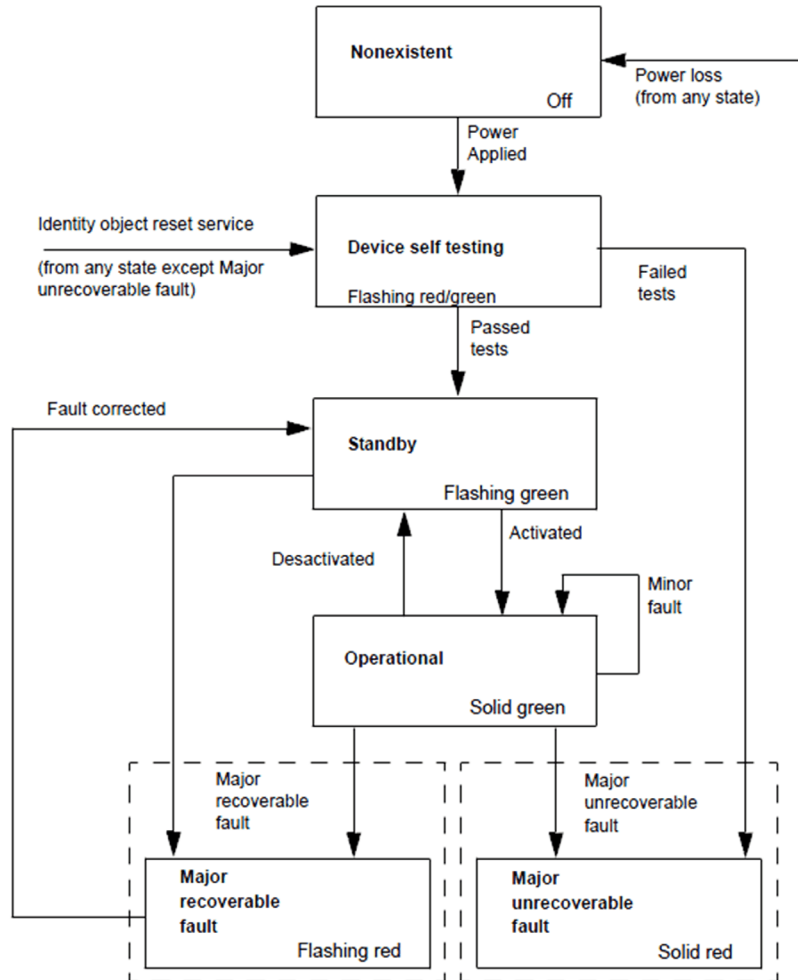

## Message Router Object (02 hex)

### Overview

The message router object is the element through which all the `Explicit messages` objects pass in order to be directed towards the truly destined objects.

### Class Code

| Hexadecimal | Decimal |
|-------------|---------|
| 02 hex      | 2       |

### Class Attributes

| Attribute ID | Access | Name          | Need | Data type | Value | Details                     |
|--------------|--------|---------------|------|-----------|-------|-----------------------------|
| 1            | Get    | Revision      | Opt. | UINT      | X     | Revision index of the class |
| 2            | Get    | Max instances | Opt. | UINT      | 1     | 1 defined instance          |

## TCP/IP Interface Object (F5 hex)

### Supported Class Attributes

| Attribute ID | Access | Name                         | Data type | Value | Detail                      |
|--------------|--------|------------------------------|-----------|-------|-----------------------------|
| 1            | Get    | Revision                     | UINT      | X     | Revision index of the class |
| 2            | Get    | Max instances                | UINT      | 1     | 1 defined instance          |
| 3            | Get    | Number of instances          | UINT      | 1     | –                           |
| 4            | Get    | Optional attribute list      | UINT      | 1     | –                           |
| 5            | Get    | Optional service list        | UINT      | 1     | –                           |
| 6            | Get    | Max ID of class attributes   | UINT      | 7     | –                           |
| 7            | Get    | Max ID of instance attribute | UINT      | 6     | –                           |

### Supported Instance Attributes

| Attribute ID                                                                                                                                                                                                                                                                                                              | Access  | Name                     | Data type                  | Detail                                                                                                                                                                                                                                                                                                                                                                                                                                                                                                                                                               |
|---------------------------------------------------------------------------------------------------------------------------------------------------------------------------------------------------------------------------------------------------------------------------------------------------------------------------|---------|--------------------------|----------------------------|----------------------------------------------------------------------------------------------------------------------------------------------------------------------------------------------------------------------------------------------------------------------------------------------------------------------------------------------------------------------------------------------------------------------------------------------------------------------------------------------------------------------------------------------------------------------|
| 1                                                                                                                                                                                                                                                                                                                         | Get     | Status                   | DWORD                      | 0 = The interface configuration attribute has not been configured<br>1 = The interface configuration attribute contains valid configuration                                                                                                                                                                                                                                                                                                                                                                                                                          |
| 2                                                                                                                                                                                                                                                                                                                         | Get     | Configuration capability | DWORD                      | Bit 0 = 1 (TRUE) shall indicate that the device is capable of obtaining its network configuration via BOOTP<br>Bit 1 = 1 (TRUE) shall indicate that the device is capable of resolving host names by querying a DNS server<br>Bit 2 = 1 (TRUE) shall indicate that the device is capable of obtaining its network configuration via DHCP<br>Bit 3 = 1 (TRUE) shall indicate that the device is capable of sending its host name in the DHCP request<br>Bit 4 = 1 (TRUE) shall indicate that the Interface Configuration attribute is settable.<br>Bit 5-31: reserved |
| 3                                                                                                                                                                                                                                                                                                                         | Get/Set | Configuration control    | DWORD                      | Bits 0-3 start-up configuration<br>0 = The device shall use the interface configuration values previously stored<br>1 = The device shall obtain its interface configuration values via BOOTP<br>2 = The device shall obtain its interface configuration values via DHCP upon start-up <sup>(1)</sup><br>3-15 = Reserved for future use<br>Bit 4 = 1 (TRUE), the device shall resolve host names by querying a DNS server<br>Bit 5-31: reserved                                                                                                                       |
| 4                                                                                                                                                                                                                                                                                                                         | Get     | Physical link object     | STRUCT of<br>UINT<br>EPATH | Path size<br>Path: Logical segments identifying the physical link object<br>Example [20][F6][24][01]: [20] = 8-bit class segment type;<br>[F6] = Ethernet link object class; [24] = 8-bit instance segment type; [01] = instance 1                                                                                                                                                                                                                                                                                                                                   |
| <p><sup>(1)</sup> If set option board parameter OBP:FDRU=0 is also set to implicitly disable the FDR mechanism on the DHCP protocol. This to be compatible with CIP tools that has configured the device to operate in a non-FDR specific environment. You have to manually enable the feature if you wish to use it.</p> |         |                          |                            |                                                                                                                                                                                                                                                                                                                                                                                                                                                                                                                                                                      |

| Attribute ID                                                                                                                                                                                                                                                                                                              | Access  | Name                    | Data type                                                        | Detail                                                                                                                                                                                                                                                   |
|---------------------------------------------------------------------------------------------------------------------------------------------------------------------------------------------------------------------------------------------------------------------------------------------------------------------------|---------|-------------------------|------------------------------------------------------------------|----------------------------------------------------------------------------------------------------------------------------------------------------------------------------------------------------------------------------------------------------------|
| 5                                                                                                                                                                                                                                                                                                                         | Get/Set | Interface configuration | STRUCT of<br>UDINT<br>UDINT<br>UDINT<br>UDINT<br>UDINT<br>String | IP address (0: no address configured)<br>Network mask (0: no network mask configured)<br>Gateway address (0: no address configured)<br>Name server address (0: no address configured)<br>Name server address 2 (0: no address configured)<br>Domain name |
| 6                                                                                                                                                                                                                                                                                                                         | Get/Set | Host name               | String                                                           | Read/write name of the drive                                                                                                                                                                                                                             |
| 8                                                                                                                                                                                                                                                                                                                         | Get/Set | TTL value               | USINT                                                            | TTL value for EtherNet/IP multicast packets                                                                                                                                                                                                              |
| 9                                                                                                                                                                                                                                                                                                                         | Get/Set | Mcast config            | Struct Of.                                                       | IP multicast address configuration                                                                                                                                                                                                                       |
|                                                                                                                                                                                                                                                                                                                           |         | Alloc control           | USINT                                                            | 0 - Use default allocation algorithm to generate multicast addresses<br>1 - Multicast addresses shall be allocated according to the values in Num Mcast and Mcast Start Addr                                                                             |
|                                                                                                                                                                                                                                                                                                                           |         | Reserved                | USINT                                                            | Shall be 0                                                                                                                                                                                                                                               |
|                                                                                                                                                                                                                                                                                                                           |         | Num Mcast               | UINT                                                             | Number of multicast addresses to allocate for EtherNet/IP                                                                                                                                                                                                |
|                                                                                                                                                                                                                                                                                                                           |         | Mcast Start Addr        | UDINT                                                            | Starting multicast address from which to begin allocation                                                                                                                                                                                                |
| <p><sup>(1)</sup> If set option board parameter OBP:FDRU=0 is also set to implicitly disable the FDR mechanism on the DHCP protocol. This to be compatible with CIP tools that has configured the device to operate in a non-FDR specific environment. You have to manually enable the feature if you wish to use it.</p> |         |                         |                                                                  |                                                                                                                                                                                                                                                          |

**Supported Class Services**

| Service code | Service name         | Description         |
|--------------|----------------------|---------------------|
| 01 hex       | Get_Attribute_All    | Read all attributes |
| 0E hex       | Get_Attribute_Single | Read one attribute  |
| 10 hex       | Set_Attribute_Single | Write one attribute |

**Supported Instance Services**

| Service code | Service name         | Description         |
|--------------|----------------------|---------------------|
| 0E hex       | Get_Attribute_Single | Read one attribute  |
| 10 hex       | Set_Attribute_Single | Write one attribute |
| 01 hex       | Get_Attribute_All    | -                   |

### TCP/IP Interface Behavior

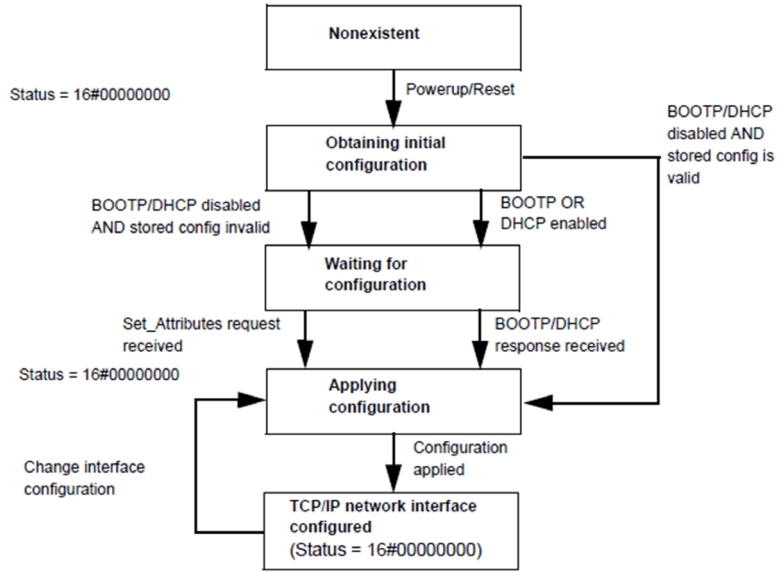

## Ethernet Link Object (F6 hex)

### Class Attributes

| Attribute ID | Access | Name                         | Data type | Value | Details                     |
|--------------|--------|------------------------------|-----------|-------|-----------------------------|
| 1            | Get    | Revision                     | UINT      | X     | Revision index of the class |
| 2            | Get    | Max instances                | UINT      | 1     | One defined instance        |
| 3            | Get    | Number of instances          | UINT      | 1     | –                           |
| 6            | Get    | Max ID of class attributes   | UINT      | 7     | –                           |
| 7            | Get    | Max ID of instance attribute | UINT      | 6     | –                           |

### Supported Instance Attributes

| Attribute ID | Access  | Name               | Data type        | Detail                                                                                                                                                                                                                                                                                                                                                                                                                                                                                                                                                                                                                                                                                                                                                                                                                                                                                                                                                                                                                                                                                                                                                                                                                                                                                                                                                                                                                                               |
|--------------|---------|--------------------|------------------|------------------------------------------------------------------------------------------------------------------------------------------------------------------------------------------------------------------------------------------------------------------------------------------------------------------------------------------------------------------------------------------------------------------------------------------------------------------------------------------------------------------------------------------------------------------------------------------------------------------------------------------------------------------------------------------------------------------------------------------------------------------------------------------------------------------------------------------------------------------------------------------------------------------------------------------------------------------------------------------------------------------------------------------------------------------------------------------------------------------------------------------------------------------------------------------------------------------------------------------------------------------------------------------------------------------------------------------------------------------------------------------------------------------------------------------------------|
| 1            | Get     | Interface speed    | UDINT            | Interface speed currently in use                                                                                                                                                                                                                                                                                                                                                                                                                                                                                                                                                                                                                                                                                                                                                                                                                                                                                                                                                                                                                                                                                                                                                                                                                                                                                                                                                                                                                     |
| 2            | Get     | Interface flags    | DWORD            | <p>Bit 0: Link status indicates whether the Ethernet 802.3 communications interface is connected to an active network. 0 indicates an inactive link; 1 indicates an active link</p> <p>Bit 1: Half/Full duplex indicates the duplex mode currently in use. 0 indicates that the interface is running half duplex; 1 indicates full duplex</p> <p>Bit 2-4: Negotiation status</p> <ul style="list-style-type: none"> <li>● 0: Auto-negotiation in progress</li> <li>● 1: Auto-negotiation and speed detection not successful</li> <li>● 2: Auto negotiation not successful but detected speedduplex was defaulted</li> <li>● 3: Successfully negotiated speed and duplex</li> <li>● 4: Auto-negotiation not attempted. Forced speedand duplex</li> </ul> <p>Bit 5: Manual setting require reset</p> <ul style="list-style-type: none"> <li>● 0: Indicates that the interface can activate changes to link parameters (autonegotiate, duplex mode, interface speed) automatically</li> <li>● 1: Indicates that the device requires a reset service be issued to its identity object in order for the changes to take effect.</li> </ul> <p>Bit 6: Local hardware error</p> <ul style="list-style-type: none"> <li>● 0: Indicates that the interface detects no local hardware error</li> <li>● 1: Indicates that a local hardware error is detected. The meaning of this is product-specific</li> </ul> <p>Bit 7-31: Reserved shall be set to zero</p> |
| 3            | Get     | Physical address   | USINT [6]        | MAC layer address                                                                                                                                                                                                                                                                                                                                                                                                                                                                                                                                                                                                                                                                                                                                                                                                                                                                                                                                                                                                                                                                                                                                                                                                                                                                                                                                                                                                                                    |
| 4            | Get     | Interface counters | –                | –                                                                                                                                                                                                                                                                                                                                                                                                                                                                                                                                                                                                                                                                                                                                                                                                                                                                                                                                                                                                                                                                                                                                                                                                                                                                                                                                                                                                                                                    |
| 5            | Get     | Media counters     | –                | –                                                                                                                                                                                                                                                                                                                                                                                                                                                                                                                                                                                                                                                                                                                                                                                                                                                                                                                                                                                                                                                                                                                                                                                                                                                                                                                                                                                                                                                    |
| 6            | Get/Set | Interface control  | –                | Force auto negotiate, half full and speed                                                                                                                                                                                                                                                                                                                                                                                                                                                                                                                                                                                                                                                                                                                                                                                                                                                                                                                                                                                                                                                                                                                                                                                                                                                                                                                                                                                                            |
| 7            | Get     | Interface type     | USINT            | 2                                                                                                                                                                                                                                                                                                                                                                                                                                                                                                                                                                                                                                                                                                                                                                                                                                                                                                                                                                                                                                                                                                                                                                                                                                                                                                                                                                                                                                                    |
| 10           | Get     | Interface label    | SHORT_STRIN<br>G | RS3: Instance 1: "Left"<br>RS3: Instance 2: "Right"<br>SERVO3: Instance 1: "Top"<br>SERVO3: Instance 2: "Bottom"<br>Service code                                                                                                                                                                                                                                                                                                                                                                                                                                                                                                                                                                                                                                                                                                                                                                                                                                                                                                                                                                                                                                                                                                                                                                                                                                                                                                                     |

**Supported Class Services**

| Service code | Service name         | Description        |
|--------------|----------------------|--------------------|
| 0E hex       | Get_Attribute_Single | Read one attribute |
| 01 hex       | Get_Attribute_All    | –                  |

**Supported Instance Services**

| Service code | Service name         | Description                    |
|--------------|----------------------|--------------------------------|
| 0E hex       | Get_Attribute_Single | Read one attribute             |
| 10 hex       | Set_Attribute_Single | Write one attribute            |
| 01 hex       | Get_Attribute_All    | –                              |
| 4C hex       | Get_And_Clear        | Same than Get_Attribute_Single |

## Assembly Object (04 hex)

### Supported Class Attributes

| Attribute ID | Access | Name                         | Data type | Value | Detail                      |
|--------------|--------|------------------------------|-----------|-------|-----------------------------|
| 1            | Get    | Revision                     | UINT      | X     | Revision index of the class |
| 2            | Get    | Max instances                | UINT      | 1     | One defined instance        |
| 3            | Get    | Number of instances          | UINT      | 1     | -                           |
| 6            | Get    | Max ID of class attributes   | UINT      | 7     | -                           |
| 7            | Get    | Max ID of instance attribute | UINT      | 3     | -                           |

### Supported Instances

| Attribute ID | Access  | Name | Data type     | Value | Details |
|--------------|---------|------|---------------|-------|---------|
| 3            | Get/Set | Data | ARRAY OF BYTE |       |         |
| 4            | Get     | Size | UINT          |       |         |

### Supported Instances for Altivar Process

| Instance | Type            | Name                              |
|----------|-----------------|-----------------------------------|
| 20       | AC drive output | CIP Basic Speed Control Output    |
| 21       | AC drive output | CIP Extended Speed Control Output |
| 70       | AC drive input  | CIP Basic Speed Control Input     |
| 71       | AC drive input  | CIP Extended Speed Control Input  |
| 100      | AC drive output | Native Drive Output               |
| 101      | AC drive input  | Native Drive Input                |

### Supported Class Services

| Service code | Service Name         | Description        |
|--------------|----------------------|--------------------|
| 0E hex       | Get_Attribute_Single | Read one attribute |

### Supported Instance Services

| Service Code | Service Name         | Description         |
|--------------|----------------------|---------------------|
| 0E hex       | Get_Attribute_Single | Read one attribute  |
| 10 hex       | Set_Attribute_Single | Write one attribute |

### Output Instance Data Description

| Instance | Byte | Bit 7              | Bit 6 | Bit 5 | Bit 4 | Bit 3 | Bit 2                                            | Bit 1 | Bit 0                              |
|----------|------|--------------------|-------|-------|-------|-------|--------------------------------------------------|-------|------------------------------------|
| 20       | 0    | X                  | X     | X     | X     | X     | Fault Reset<br>0 = No command<br>1 = Fault Reset | X     | Run Forward<br>0 = Stop<br>1 = Run |
|          | 1    | X                  | X     | X     | X     | X     | X                                                | X     | X                                  |
|          | 2-3  | Speed Actual (rpm) |       |       |       |       |                                                  |       |                                    |

| Instance | Byte  | Bit 7                                          | Bit 6                                                  | Bit 5                                                 | Bit 4                               | Bit 3                                                                                              | Bit 2                                                                                                                                           | Bit 1                                                                                                                                             | Bit 0                     |  |
|----------|-------|------------------------------------------------|--------------------------------------------------------|-------------------------------------------------------|-------------------------------------|----------------------------------------------------------------------------------------------------|-------------------------------------------------------------------------------------------------------------------------------------------------|---------------------------------------------------------------------------------------------------------------------------------------------------|---------------------------|--|
| 21       | 0     | X                                              | Net Reference<br>0 = Local, by terminal<br>1 = Network | NetCommand<br>0 = Local<br>1 = Network                | X                                   | X                                                                                                  | Fault Reset<br>0 = No command<br>1 = Fault Reset                                                                                                | Run Fwd / Reverse:<br>00: Quick stop<br>01: Run forward<br>10: Run reverse<br>11: No action (no freewheel stop as in legacy because asked by CIP) |                           |  |
|          | 1     | X                                              | X                                                      | X                                                     | X                                   | X                                                                                                  | X                                                                                                                                               | X                                                                                                                                                 | X                         |  |
|          | 2-3   | Speed Actual (rpm)                             |                                                        |                                                       |                                     |                                                                                                    |                                                                                                                                                 |                                                                                                                                                   |                           |  |
| 100      | 0-1   | I/O Scanning word 1                            |                                                        |                                                       |                                     |                                                                                                    |                                                                                                                                                 |                                                                                                                                                   |                           |  |
|          | 2-3   | I/O Scanning word 2                            |                                                        |                                                       |                                     |                                                                                                    |                                                                                                                                                 |                                                                                                                                                   |                           |  |
|          | 4-5   | I/O Scanning word 3                            |                                                        |                                                       |                                     |                                                                                                    |                                                                                                                                                 |                                                                                                                                                   |                           |  |
|          | 6-7   | I/O Scanning word 4                            |                                                        |                                                       |                                     |                                                                                                    |                                                                                                                                                 |                                                                                                                                                   |                           |  |
|          | 8-9   | I/O Scanning word 5                            |                                                        |                                                       |                                     |                                                                                                    |                                                                                                                                                 |                                                                                                                                                   |                           |  |
|          | 10-11 | I/O Scanning word 6                            |                                                        |                                                       |                                     |                                                                                                    |                                                                                                                                                 |                                                                                                                                                   |                           |  |
| 70       | 0     | X                                              | X                                                      | X                                                     | X                                   | X                                                                                                  | 0 = Stopped<br>1 = Running                                                                                                                      | X                                                                                                                                                 | 0 = No error<br>1 = Error |  |
|          | 1     | X                                              | X                                                      | X                                                     | X                                   | X                                                                                                  | X                                                                                                                                               | X                                                                                                                                                 | X                         |  |
|          | 2-3   | Speed Actual (rpm)                             |                                                        |                                                       |                                     |                                                                                                    |                                                                                                                                                 |                                                                                                                                                   |                           |  |
| 71       | 0     | At reference<br>0 = Not reached<br>1 = Reached | Ref From Net<br>0 = From terminal<br>1 = From network  | Cmd From Net<br>0 = From terminal<br>1 = From network | Ready<br>0 = Not ready<br>1 = Ready | Running Fwd / reverse<br>00: Stopped<br>01: Running Forward<br>10: Running reverse<br>11: Not used |                                                                                                                                                 | Warning<br>0 = No warning<br>1 = Warning                                                                                                          | Not used                  |  |
|          | 1     | X                                              | X                                                      | X                                                     | X                                   | X                                                                                                  | 000: Not used<br>001: Startup<br>010: Not ready<br>011: Ready<br>100: Enabled<br>101: Stopping<br>110: Fault stop<br>111: Operating state fault |                                                                                                                                                   |                           |  |
|          | 2-3   | Speed Actual (rpm)                             |                                                        |                                                       |                                     |                                                                                                    |                                                                                                                                                 |                                                                                                                                                   |                           |  |
| 101      | 0-1   | Scanner Read word 1                            |                                                        |                                                       |                                     |                                                                                                    |                                                                                                                                                 |                                                                                                                                                   |                           |  |
|          | 2-3   | Scanner Read word 2                            |                                                        |                                                       |                                     |                                                                                                    |                                                                                                                                                 |                                                                                                                                                   |                           |  |
|          | 4-5   | Scanner Read word 3                            |                                                        |                                                       |                                     |                                                                                                    |                                                                                                                                                 |                                                                                                                                                   |                           |  |
|          | 6-7   | Scanner Read word 4                            |                                                        |                                                       |                                     |                                                                                                    |                                                                                                                                                 |                                                                                                                                                   |                           |  |
|          | 8-9   | Scanner Read word 5                            |                                                        |                                                       |                                     |                                                                                                    |                                                                                                                                                 |                                                                                                                                                   |                           |  |
|          | 10-11 | Scanner Read word 6                            |                                                        |                                                       |                                     |                                                                                                    |                                                                                                                                                 |                                                                                                                                                   |                           |  |

## Connection Manager Object (06 hex)

### Class Code

| Hexadecimal | Decimal |
|-------------|---------|
| 06 hex      | 6       |

### Class Attributes

| Attribute ID | Access | Name          | Need | Data type | Value | Details                     |
|--------------|--------|---------------|------|-----------|-------|-----------------------------|
| 1            | Get    | Revision      | Opt. | UINT      | X     | Revision index of the class |
| 2            | Get    | Max instances | Opt. | UINT      | 4     | 3 defined instance          |

### Attributes of Instance 1 - Explicit Message Instance

| Attribute | Access  | Name                               | Need | Data type        | Value           | Details                                                    |
|-----------|---------|------------------------------------|------|------------------|-----------------|------------------------------------------------------------|
| 1         | Get     | State                              | Req. | USINT            | –               | 0: Non-existent<br>3: Established<br>5: Deferred<br>Delete |
| 2         | Get     | Instance_type                      | Req. | USINT            | 0               | Explicit Message                                           |
| 3         | Get     | TransportClass_trigger             | Req. | BYTE             | 83 hex          | Class 3 server                                             |
| 4         | Get     | Produced_connection_id             | Req. | UINT             | 10xxxxxx01<br>1 | xxxxxx = Node<br>address                                   |
| 5         | Get     | Consumed_connection_id             | Req. | UINT             | 10xxxxxx10<br>0 | xxxxxx = Node<br>address                                   |
| 6         | Get     | Initial_comm_characteristics       | Req. | BYTE             | 21 hex          | Explicit<br>messaging via<br>Group 2                       |
| 7         | Get     | Produced_connection_size           | Req. | UINT             | 36              | Produced data<br>maximum size<br>(in bytes)                |
| 8         | Get     | Consumed_connection_size           | Req. | UINT             | 36              | Consumed data<br>maximum size<br>(in bytes)                |
| 9         | Get/Set | Expected_packet_rate               | Req. | UINT             | 2500            | 2.5 sec.<br>(TimeOut)                                      |
| 12        | Get/Set | Watchdog_timeout_action            | Req. | USINT            | 1 or 3          | 1: Auto-Delete<br>3: Deferred<br>Delete (Default)          |
| 13        | Get     | Produced connection<br>path length | Req. | UINT             | 0               | Length of<br>attribute 14 data                             |
| 14        | Get     | Produced connection<br>path        | Req. | Array of<br>UINT | Null            | Not used                                                   |
| 15        | Get     | Consumed connection<br>path length | Req. | UINT             | 0               | Length of<br>attribute 16 data                             |
| 16        | Get     | Consumed connection<br>path        | Req. | Array of<br>UINT | Null            | Not used                                                   |

For details, refer to Ethernet/ specification for more information.

**Supported Class Attributes**

| Attribute ID | Access | Name                          | Data type | Value | Details                                     |
|--------------|--------|-------------------------------|-----------|-------|---------------------------------------------|
| 1            | Get    | Revision                      | UINT      | X     | Revision index of the class                 |
| 2            | Get    | Max Instances                 | UINT      | 1     | 1 defined instance                          |
| 3            | Get    | Number of Instances           | UINT      | 1     | –                                           |
| 4            | Get    | Optional attribute list       | STRUCT of | –     | List of optional attribute numbers          |
| 6            | Get    | Max ID of class attributes    | UINT      | 7     | –                                           |
| 7            | Get    | Max ID of instance attributes | UINT      | –     | Attribute ID number of last class attribute |

**Supported Instance1 (Explicit) Attributes**

| Attribute ID | Access | Name                   | Data type | Details                                                                                                             |
|--------------|--------|------------------------|-----------|---------------------------------------------------------------------------------------------------------------------|
| 1            | Get    | Open Requests          | UINT      | Number of forward open service requests received.                                                                   |
| 2            | Get    | Open Format Rejects    | UINT      | Number of forward open service requests which were rejected due to bad format.                                      |
| 3            | Get    | Open Resources Rejects | UINT      | Number of forward open service requests which were rejected due to lack of resources.                               |
| 4            | Get    | Open Other Rejects     | UINT      | Number of forward open service requests which were rejected for reasons other than bad format or lack of resources. |
| 5            | Get    | Close Requests         | UINT      | Number of forward close service requests received.                                                                  |
| 6            | Get    | Close Format Requests  | UINT      | Number of forward close service requests which were rejected due to bad format.                                     |
| 7            | Get    | Close Other Requests   | UINT      | Number of forward close service requests which were rejected for reasons other than bad format.                     |
| 8            | Get    | Connection Timeouts    | UINT      | Total number of connection timeouts that have occurred in connections controlled by this connection manager.        |

**Supported Class Services**

| Service code | Service name         | Description         |
|--------------|----------------------|---------------------|
| 01 hex       | Get_Attribute_All    | Read all attributes |
| 0E hex       | Get_Attribute_Single | Read one attribute  |

**Supported Instance Services**

| Service code | Service name         | Description                                        |
|--------------|----------------------|----------------------------------------------------|
| 0E hex       | Get_Attribute_Single | Read one attribute                                 |
| 10 hex       | Set_Attribute_Single | Write one attribute                                |
| 4E hex       | Forward_Close        | Closes a connection                                |
| 54 hex       | Forward_Open         | Opens a connection, maximum data size is 511 bytes |

## Motor Data Object (28 hex)

### Supported Class Attributes

| Attribute ID | Access | Name                         | Data type | Value | Details                     |
|--------------|--------|------------------------------|-----------|-------|-----------------------------|
| 1            | Get    | Revision                     | UINT      | X     | Revision index of the class |
| 2            | Get    | Max Instances                | UINT      | 1     | One defined instance        |
| 3            | Get    | Number of Instances          | UINT      | 1     | –                           |
| 6            | Get    | Max ID of class attributes   | UINT      | 7     | –                           |
| 7            | Get    | Max ID of instance attribute | UINT      | 15    | –                           |

### Supported Instance Attributes

| Attribute ID | Access  | Name            | Need | Data type     | ATV | Details                                                                                                                                                         |
|--------------|---------|-----------------|------|---------------|-----|-----------------------------------------------------------------------------------------------------------------------------------------------------------------|
| 1            | Get     | NumAttr         | Opt. | USINT         | No  | –                                                                                                                                                               |
| 2            | Get     | Attributes List | Opt. | USINT (ARRAY) | No  | –                                                                                                                                                               |
| 3            | Get     | MotorType       | Req. | USINT         | Yes | 7                                                                                                                                                               |
| 6            | Get/Set | RatedCurrent    | Req. | UINT          | Yes | Motor nominal current<br>Linked to NCR drive parameter.<br>NCR unit is 0,1 A as attribute 6                                                                     |
| 7            | Get/Set | RatedVoltage    | Req. | UINT          | Yes | Motor nominal voltage<br>Linked to UNS drive parameter<br>UNS unit is 1 V as attribute 7                                                                        |
| 8            | Get/Set | RatedPower      | Opt. | UINT          | No  | –                                                                                                                                                               |
| 9            | Get/Set | RatedFreq       | Opt. | UINT          | Yes | Motor nominal frequency<br>linked to FRS drive parameter<br>FRS unit is 0,1 Hz.<br>The parameter value has to be divided by 10 to be in the unit of attribute 9 |
| 12           | Get/Set | PoleCount       | Opt. | UINT          | No  | –                                                                                                                                                               |
| 15           | Get/Set | BaseSpeed       | Opt. | UINT          | Yes | Motor nominal speed<br>Linked to NSP drive parameter<br>NSP unit is 1 rpm as attribute 15                                                                       |

### Supported Class Services

| Service code | Service name         | Description        |
|--------------|----------------------|--------------------|
| 0E hex       | Get_Attribute_Single | Read one attribute |

### Supported Instance Services

| Service code | Service name         | Description         |
|--------------|----------------------|---------------------|
| 0E hex       | Get_Attribute_Single | Read one attribute  |
| 10 hex       | Set_Attribute_Single | Write one attribute |

## Control Supervisor Object (29 hex)

### Supported Class Attributes

| Attribute ID | Access | Name                         | Data type | Value | Details                     |
|--------------|--------|------------------------------|-----------|-------|-----------------------------|
| 1            | Get    | Revision                     | UINT      | X     | Revision index of the class |
| 2            | Get    | Max Instances                | UINT      | 1     | One defined instance        |
| 3            | Get    | Number of Instances          | UINT      | 1     | -                           |
| 6            | Get    | Max ID of class attributes   | UINT      | 7     | -                           |
| 7            | Get    | Max ID of instance attribute | UINT      | 17    | -                           |

### Supported Instance Attributes for Schneider Electric

| Attribute ID | Access  | Name           | Data type | Details                                                                                                                                       |
|--------------|---------|----------------|-----------|-----------------------------------------------------------------------------------------------------------------------------------------------|
| 3            | Get/Set | Run Fwd        | BOOL      | On edge (0 --> 1)                                                                                                                             |
| 4            | Get/Set | Run Rev        | BOOL      | On edge (0 --> 1)                                                                                                                             |
| 5            | Get/Set | Net Ctrl       | BOOL      | 0: Local control<br>1: Network control (default)                                                                                              |
| 6            | Get     | State          | USINT     | See machine status:<br>0:<br>1: Startup<br>2: Not_Ready<br>3: Ready<br>4: Enabled<br>5: Stopping<br>6: Fault_stop<br>7: Operating state fault |
| 7            | Get     | Running Fwd    | BOOL      | ETA.15 = 0                                                                                                                                    |
| 8            | Get     | Running Rev    | BOOL      | ETA.15 = 1                                                                                                                                    |
| 9            | Get     | Ready          | BOOL      | ETA.1 = 1                                                                                                                                     |
| 10           | Get     | Error detected | BOOL      | ETA.3 = 1                                                                                                                                     |
| 12           | Get/Set | Fault Reset    | BOOL      | CMD.7 = 1.                                                                                                                                    |
| 13           | Get     | Error Code     | USINT     | Parameter <i>E r r d</i>                                                                                                                      |
| 15           | Get     | Ctrl From Net  | BOOL      | 0: Local Control<br>1: Network Control                                                                                                        |
| 16           | Get/Set | DN Error Mode  | USINT     | Action on loss of CIP network.<br>0: Stop + <b>[Fieldbus Com Interrupt] C n F</b> detected error<br>1: Ignored                                |
| 17           | Get/Set | Force error    | BOOL      | Force <b>[Fieldbus Com Interrupt] C n F</b> detected error (On edge)                                                                          |

### Supported Class Services

| Service code | Service name         | Description        |
|--------------|----------------------|--------------------|
| 0E hex       | Get_Attribute_Single | Read one attribute |

### Supported Instance Services

| Service code | Service name         | Description         |
|--------------|----------------------|---------------------|
| 0E hex       | Get_Attribute_Single | Read one attribute  |
| 10 hex       | Set_Attribute_Single | Write one attribute |
| 05 hex       | Reset                | Reset drive         |

Control Supervisor States

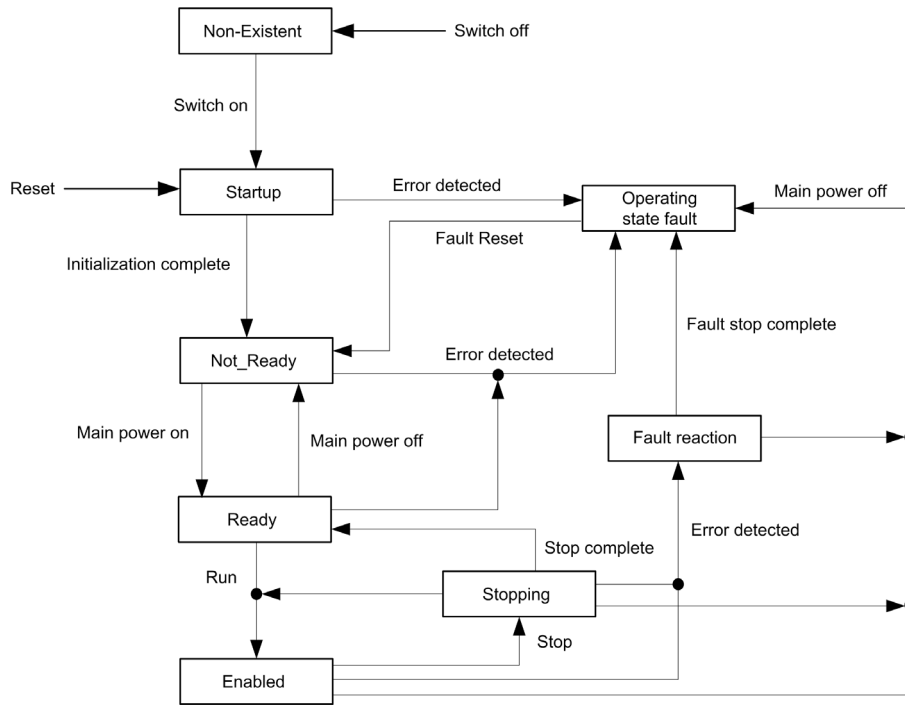

## AC/DC Drive Object (2A hex)

### Supported Class Attributes

| Attribute ID | Access | Name                         | Data type | Value | Details                     |
|--------------|--------|------------------------------|-----------|-------|-----------------------------|
| 1            | Get    | Revision                     | UINT      | X     | Revision index of the class |
| 2            | Get    | Max Instances                | UINT      | 1     | 1 defined instance          |
| 3            | Get    | Number of Instances          | UINT      | 1     | –                           |
| 6            | Get    | Max ID of class attributes   | UINT      | 7     | –                           |
| 7            | Get    | Max ID of instance attribute | UINT      | 21    | –                           |

### Supported Instance

| Attribute ID | Access  | Name            | Need | Data type     | ATV | Comments                                                                                                                                                                                                                                                                  |
|--------------|---------|-----------------|------|---------------|-----|---------------------------------------------------------------------------------------------------------------------------------------------------------------------------------------------------------------------------------------------------------------------------|
| 1            | Get     | NumAttr         | Opt. | USINT         | No  | –                                                                                                                                                                                                                                                                         |
| 2            | Get     | Attributes List | Opt. | USINT (ARRAY) | No  | –                                                                                                                                                                                                                                                                         |
| 3            | Get     | At Reference    | Opt. | BOOL          | Yes | Use the result of the “reference reached” function of the device.<br>No more, no less specific adjustment than what is in the drive function.                                                                                                                             |
| 4            | Get/Set | NetRef          | Req. | BOOL          | Yes | Image of the NetRef signal received from the network.<br>'Get' order returns the value written by 'Set' order.<br>Used to manage the reference channel.                                                                                                                   |
| 6            | Get     | Drive mode      | Req. | USINT         | Yes | Used to get the drive mode.<br>In the standard, the attribute can also be used to set the drive mode, but it is not possible on our products.<br>Value is fixed at 1.<br><b>NOTE:</b> On other drives this value main depends on the Motor control law set in the device. |
| 7            | Get     | Speed Actual    | Req. | INT           | Yes | Used to get the value of the motor Speed.<br>Unit: rpm                                                                                                                                                                                                                    |
| 8            | Get/Set | SpeedRef        | Req. | INT           | Yes | Image of the speed reference signal received from the network.<br>Unit: rpm<br>'Get' order returns the value written by 'Set' order<br>Used to set the speed reference in the drive.                                                                                      |
| 9            | Get     | Current Actual  | Opt. | INT           | Yes | Used to get the value of the current in the motor.<br>Unit: 0.1 Amps                                                                                                                                                                                                      |
| 10           | Get/Set | Current Limit   | Opt. | INT           | Yes | Used to set or get the current value used for the motor thermal protection.<br>Unit: 0,1 Amps.                                                                                                                                                                            |
| 11           | Get     | Torque Actual   | Opt. | INT           | Yes | Used to get the value of the motor torque.<br>Unit: 1 N.m                                                                                                                                                                                                                 |

(1) For the standard, the acceleration, and deceleration time are given to go from 0 to [HighSpdLimit] (attribute 21 of AC/DC drive object). For the drive, the acceleration and deceleration time are given to go from 0 to the motor nominal frequency ((Fr5) parameter).

(2) In the drive, the unit of acceleration and deceleration time depends on INR parameter.

( INR ) = 0: acceleration and deceleration time are in 0,01 s

( INR ) = 1 (factory setting): acceleration and deceleration time are in 0,1 s

( INR ) = 2: acceleration and deceleration time are in 1 s

The minimal requirement is to have this attribute in ms when ( INR ) parameter is in factory setting.

| Attribute ID | Access  | Name                | Need  | Data type | ATV | Comments                                                                                                   |
|--------------|---------|---------------------|-------|-----------|-----|------------------------------------------------------------------------------------------------------------|
| 15           | Get     | Power Actual        | Opt.  | INT       | No  | Used to get the value of the output power. Unit 1 <--> 1/2PowerScale.                                      |
| 18           | Get/Set | AccelTime           | Opt.  | UINT      | Yes | Used to get and set the acceleration time <sup>(1)(2)</sup>                                                |
| 19           | Get/Set | DecelTime           | Opt.  | UINT      | Yes | Used to get and set the deceleration time <sup>(1)(2)</sup>                                                |
| 20           | Get/Set | LowSpdLimit         | Opt.  | UINT      | Yes | Used to get and set the low speed limit. Units: rpm                                                        |
| 21           | Get/Set | HighSpdLimit        | Opt.  | UINT      | Yes | Used to get and set the high speed limit. Units: rpm                                                       |
| 26           | Get/Set | PowerScale          | Opt.  | SINT      | No  | -                                                                                                          |
| 28           | Get/Set | TimeScale           | Opt.  | SINT      | No  | Default value = 0                                                                                          |
| 29           | Get     | RefFromNet          | Opt.  | BOOL      | No  | Used to know if the drive is processing the reference sent by the network that asks the attribute 29 value |
| 46           | Get     | Cumulative Run Time | Brand | UINT      | No  | Cumulative run time                                                                                        |

(1) For the standard, the acceleration, and deceleration time are given to go from 0 to **[HighSpdLimit]** (attribute 21 of AC/DC drive object). For the drive, the acceleration and deceleration time are given to go from 0 to the motor nominal frequency ((*F r 5*) parameter).

(2) In the drive, the unit of acceleration and deceleration time depends on INR parameter.  
 ( *i n r* ) = 0: acceleration and deceleration time are in 0,01 s  
 ( *i n r* ) = 1 (factory setting): acceleration and deceleration time are in 0,1 s  
 ( *i n r* ) = 2: acceleration and deceleration time are in 1 s  
 The minimal requirement is to have this attribute in ms when ( *i n r* ) parameter is in factory setting.

| Attribute ID | Details                                                                                                                                                                                           |
|--------------|---------------------------------------------------------------------------------------------------------------------------------------------------------------------------------------------------|
| 3            | Attribute value = value of bit 10 of ETA drive parameter (TBC)                                                                                                                                    |
| 7            | Motor speed.<br>Linked to ( <i>r F r d</i> ) drive parameter (TBC).<br>( <i>r F r d</i> ) is in 1 rpm as attribute 7                                                                              |
| 8            | Speed reference.<br>Linked to ( <i>L F r d</i> ) drive parameter (TBC).<br>( <i>L F r d</i> ) is in 1 rpm as attribute 8                                                                          |
| 9            | Actual current in the motor.<br>Linked to ( <i>L C r</i> ) drive parameter.( <i>L C r</i> ) is in 0,1 A as attribute 9                                                                            |
| 10           | Current value used for the motor thermal protection.<br>Linked to ( <i>i t H</i> ) drive parameter.<br>( <i>i t H</i> ) is in 0,1 A as attribute 10                                               |
| 11           | Actual torque in the motor.<br>Linked to ( <i>o t r n</i> ) drive parameter (TBC).<br>( <i>o t r n</i> ) is in 0,1 N.m.<br>The value has to be multiplied by 10 to be in the unit of attribute 11 |
| 18           | Acceleration time.<br>Linked to ( <i>A C C</i> ) drive parameter.<br>See note (2) of the specification above                                                                                      |
| 19           | Deceleration time.<br>Linked to ( <i>d E C</i> ) drive parameter.<br>See note (2) of the specification above                                                                                      |
| 20           | Low speed.<br>Linked to ( <i>S n , L</i> ) drive parameter.<br>( <i>S n , L</i> ) is in 1 rpm as attribute 20                                                                                     |
| 21           | High speed.<br>Linked to ( <i>S n H L</i> ) drive parameter.<br>( <i>S n H L</i> ) is in 1 rpm as attribute 21                                                                                    |

**Supported Class Services**

| Service code | Service name         | Description        |
|--------------|----------------------|--------------------|
| 0E hex       | Get_Attribute_Single | Read one attribute |

**Supported Instance Services**

| Service code | Service name         | Description         |
|--------------|----------------------|---------------------|
| 0E hex       | Get_Attribute_Single | Read one attribute  |
| 10 hex       | Set_Attribute_Single | Write one attribute |

## Application Object (70 hex to C7 hex) / Explicit Messaging

### Application Object Behavior

Class = ((AdL - 3000) / 200) + 70 hex

Instance = 1

Attribute = (AdL % 200) + 1

AdL = (class - 70 h) \* 200 + attribute - 1 + 3000

This rule allows the access to address under 20599. The other addresses are not accessible.

The drive parameters are grouped into classes.

- Each application class has only one instance.
- Each instance groups 200 parameters.
- Each attribute in an instance relates to a parameter.

### Supported Class Attributes

| Attribute ID | Access | Name                         | Data type | Value | Details                     |
|--------------|--------|------------------------------|-----------|-------|-----------------------------|
| 1            | Get    | Revision                     | UINT      | X     | Revision index of the class |
| 2            | Get    | Max Instances                | UINT      | 1     | One defined instance        |
| 3            | Get    | Number of Instances          | UINT      | 1     | -                           |
| 6            | Get    | Max ID of class attributes   | UINT      | 7     | -                           |
| 7            | Get    | Max ID of instance attribute | UINT      | X     | -                           |

### Supported Instance Attributes

| Attribute ID | Access  | Name                        | Data type | Details                                   |
|--------------|---------|-----------------------------|-----------|-------------------------------------------|
| 1            | Get/Set | 1st parameter of the block  | UINT      | Value returned by the drive at address xx |
| -            | -       | -                           | -         | Value returned by the drive at address xx |
| X            | Get/Set | Last parameter of the block | UINT      | Value returned by the drive at address xx |

### Supported Class Services

| Service code | Service name         | Description        |
|--------------|----------------------|--------------------|
| 0E hex       | Get_Attribute_Single | Read one attribute |

### Supported Instance Services

| Service code | Service name         | Description         |
|--------------|----------------------|---------------------|
| 0E hex       | Get_Attribute_Single | Read one attribute  |
| 10 hex       | Set_Attribute_Single | Write one attribute |

## Base Energy Object (4E hex)

### Overview

The base energy object acts as an **Energy Supervisor** for CIP Energy implementations. It is responsible for providing a time base for energy values, provides energy mode services, and can provide aggregation services for aggregating energy values up through the various levels of an industrial facility. It also provides a standard format for reporting energy metering results.

### Class Code

| Hexadecimal | Decimal |
|-------------|---------|
| 4E hex      | 78      |

### Class Attributes

| Attribute ID | Access | Name                | Data type | Value | Details                     |
|--------------|--------|---------------------|-----------|-------|-----------------------------|
| 1            | Get    | Revision            | UINT      | X     | Revision index of the class |
| 2            | Get    | Max instances       | UINT      | 1     | 1 defined instance          |
| 3            | Get    | Number of instances | UINT      | 1     | -                           |

### Instance Attributes

| Attribute ID | Access | Name                            | Data type       | Value | Details                               |
|--------------|--------|---------------------------------|-----------------|-------|---------------------------------------|
| 1            | Get    | Energy/Resource Type            | UINT            | 1     | 1 = Electrical                        |
| 2            | Get    | Base Energy Object Capabilities | UINT            | -     | See definition in the following table |
| 3            | Get    | Energy Accuracy                 | UINT            | -     | See definition in the following table |
| 4            | Get    | Energy Accuracy Basis           | UINT            | -     | See definition in the following table |
| 7            | Get    | Consumed Energy Odometer        | ODOMETER        | -     | The consumed energy value in kWh      |
| 8            | Get    | Generated Energy Odometer       | ODOMETER        | -     | The generated energy value in kWh     |
| 9            | Get    | Net Energy Odometer             | SIGNED_ODOMETER | -     | The generated energy value in kWh     |

The following table provides the Odometer and Signed\_Odometer structure principle:

| Data Type Structure                                     |                            | Description of Data Type Element | Semantics of Value           |
|---------------------------------------------------------|----------------------------|----------------------------------|------------------------------|
| ODOMETER STRUCT of:                                     | SIGNED_ODOMETER STRUCT of: | -                                | -                            |
| UINT                                                    | INT                        | $x10^n$                          | $\pm Unit1 \times 10^n$      |
| UINT                                                    | INT                        | $x10^{n+3}$                      | $\pm Unit1 \times 10^{n+3}$  |
| UINT                                                    | INT                        | $x10^{n+6}$                      | $\pm Unit1 \times 10^{n+6}$  |
| UINT                                                    | INT                        | $x10^{n+9}$                      | $\pm Unit1 \times 10^{n+9}$  |
| UINT                                                    | INT                        | $x10^{n+12}$                     | $\pm Unit1 \times 10^{n+12}$ |
| The valid range of n shall be a SINT between 0 and -15. |                            |                                  |                              |

The following table provides the Odometer type in Kilowatt-hours units and n = -3:

| $x10^{n+12}$                   | $x10^{n+9}$                    | $x10^{n+6}$                    | $x10^{n+3}$          | $x10^n$                       |
|--------------------------------|--------------------------------|--------------------------------|----------------------|-------------------------------|
| Terawatt-hours (kWh x $10^9$ ) | Gigawatt-hours (kWh x $10^6$ ) | Megawatt-hours (kWh x $10^3$ ) | Kilowatt-hours (kWh) | Watt-hours (kWh x $10^{-3}$ ) |

**Attribute 1-Energy/Resource Type**

This attribute specifies the type of energy managed by this Base Energy Object instance. If this attribute value = 1 Electrical, then this instance of the Base Energy Object is associated with a corresponding instance of the Electrical Energy Object pointed to by attribute 12.

**Attribute 2-Base Energy Object Capabilities**

The value indicates how **Energy Odometer** values are generated and/or how **Energy Transfer Rates** are generated or specified.

| Value | Name            | Definition                                                                                 |
|-------|-----------------|--------------------------------------------------------------------------------------------|
| 0     | Energy Measured | Indicates that the instance reports energy values that are directly measured by the device |

**Attribute 3-Energy Accuracy**

This attribute specifies the accuracy of metering energy results. By default, it specifies the accuracy of energy metering results as 100 times the percentage of reading. A value of 500 indicates a device accuracy of 5% of reading.

**Attribute 4-Energy Accuracy Basis**

This optional attribute defines the basis of the Energy Accuracy attribute.

| Value | Name                | Definition                                           |
|-------|---------------------|------------------------------------------------------|
| 0     | Per cent of reading | Error = (Energy Accuracy value / 100) * Delta Energy |

**Attribute 7-Consumed Energy Odometer**

The Consumed Energy Odometer represents a range of 0 kWh to 999,999,999,999.999 kWh.

| Section                      | Description                                                                            |
|------------------------------|----------------------------------------------------------------------------------------|
| Consumed energy value in kWh | Odometer structure: 5x16 bits parameters give a value of consumed energy value in kWh. |

**Attribute 8-Generated Energy Odometer**

The generated energy odometer represents a range of 0 kWh to 999,999,999,999.999 kWh.

| Section                       | Description                                                                             |
|-------------------------------|-----------------------------------------------------------------------------------------|
| Generated energy value in kWh | Odometer structure: 5x16 bits parameters give a value of generated energy value in kWh. |

**Attribute 9-Net Energy Odometer**

The net energy odometer represents a range of -999,999,999,999.999 kWh to 999,999,999,999.999 kWh.

| Section                   | Description                                                                                |
|---------------------------|--------------------------------------------------------------------------------------------|
| Total energy value in kWh | Signed odometer structure: 5x16 bits parameters give a value of total energy value in kWh. |

## Electrical Energy Object (4F hex)

### Overview

This object is used to provide unified electrical energy reporting capability for CIP enabled devices and processes. Energy reporting is typically related to the measurement of various metering results. This object provides for the consistent reporting of electrical energy data. Electrical energy is assigned a separate object to accommodate its alternating and polyphase characteristics, which result in a collection of attributes that are unique among energy sources.

Each instance of the Electrical Energy Object shall be associated with an instance of the Base Energy Object (class code 0x4E). Instance attribute 41, **Associated Base Energy Object Path** is used to define this association.

### Class Code

| Hexadecimal | Decimal |
|-------------|---------|
| 4F hex      | 79      |

### Class Attributes

| Attribute ID | Access | Name                | Data type | Value | Details                     |
|--------------|--------|---------------------|-----------|-------|-----------------------------|
| 1            | Get    | Revision            | UINT      | X     | Revision index of the class |
| 2            | Get    | Max instances       | UINT      | 1     | 1 defined instance          |
| 3            | Get    | Number of instances | UINT      | 1     | –                           |

### Instance Attributes

| Attribute ID | Access | Name                               | Data type         | Value | Details                                                                                                                        |
|--------------|--------|------------------------------------|-------------------|-------|--------------------------------------------------------------------------------------------------------------------------------|
| 1            | Get    | Real Energy Consumed Odometer      | ODOMETE R         | –     | The total real energy consumed in kWh                                                                                          |
| 2            | Get    | Real Energy Generated Odometer     | ODOMETE R         | –     | The total real energy generated in kWh                                                                                         |
| 3            | Get    | Real Energy Net Odometer           | SIGNED_ ODOMETE R | –     | The running total of Real Energy Consumed minus Real Energy Generated in kWh                                                   |
| 9            | Get    | Line Frequency                     | REAL              | –     | Line Frequency (0.1 Hertz)<br>Available on Low harmonic drives                                                                 |
| 13           | Get    | Average Current                    | REAL              | –     | RMS line current of three-phase average (0.1 Amps)<br>Available on Low harmonic drives                                         |
| 19           | Get    | L1-L2 Voltage                      | REAL              | –     | RMS L1 to L2 voltage (0.1 Volts)                                                                                               |
| 20           | Get    | L2-L3 Voltage                      | REAL              | –     | RMS L2 to L3 voltage (0.1 Volts)                                                                                               |
| 21           | Get    | L3-L1 Voltage                      | REAL              | –     | RMS L3 to L1 voltage (0.1 Volts)                                                                                               |
| 22           | Get    | Average L-L Voltage                | REAL              | –     | RMS line to line voltage three-phase average (0.1 Volts)                                                                       |
| 27           | Get    | Total Real Power                   | REAL              | –     | Total real power, signed to show direction (Watts)                                                                             |
| 41           | Get    | Associated Base Energy Object Path | SRUCT of:         | –     | Path to associated Base Energy Object instance                                                                                 |
|              |        | Path Size                          | UNIT              | –     | Size of path (in words)                                                                                                        |
|              |        | Path                               | Padded EPATH      | –     | This is an array of bytes whose contents convey the application path and other information of the request for this transaction |

**Attribute 1-Real Energy Consumed Odometer**

The Real Energy Consumed Odometer represents a range of 0 kWh to 999,999,999,999.999 kWh.

| Section                                 | Description                                                                            |
|-----------------------------------------|----------------------------------------------------------------------------------------|
| Total real energy consumed value in kWh | Odometer structure: 5x16 bits parameters give a value of consumed energy value in kWh. |

**Attribute 2-Real Energy Generated Odometer**

The Real Energy Generated Odometer represents a range of 0 kWh to 999,999,999,999.999 kWh.

| Section                                  | Description                                                                   |
|------------------------------------------|-------------------------------------------------------------------------------|
| Total real energy generated value in kWh | Odometer structure: parameters give a value of generated energy value in kWh. |

**Attribute 3-Real Energy Net Odometer**

The Real Energy Net Odometer represents a range of -999,999,999,999.999 kWh to 999,999,999,999.999 kWh.

| Section                            | Description                                                                                         |
|------------------------------------|-----------------------------------------------------------------------------------------------------|
| Total real energy net value in kWh | Signed odometer structure: 5x16 bits parameters give a value of total real energy net value in kWh. |

**Attribute 27- Total Real Power**

This attribute expresses the time rate of energy transfer as a REAL value, expressed in engineering units of kilowatts (kW). A positive value indicates consumption of energy, while a negative value indicates generation of energy.

**Attribute 41- Associated Base Energy Object Path**

The Base Energy Object (class code 0x4E) acts as an **energy supervisor** for CIP Energy implementations.

---

# Chapter 3

## Hardware Setup

---

### What Is in This Chapter?

This chapter contains the following topics:

| Topic                      | Page |
|----------------------------|------|
| Hardware Presentation      | 62   |
| Firmware Version           | 63   |
| Installation of the Module | 64   |
| Electrical Installation    | 65   |
| Cable Routing Practice     | 66   |

## Hardware Presentation

### Ethernet Dual Port

The figure shows VW3A3720 Ethernet Module equipped with 2 RJ45 connectors:

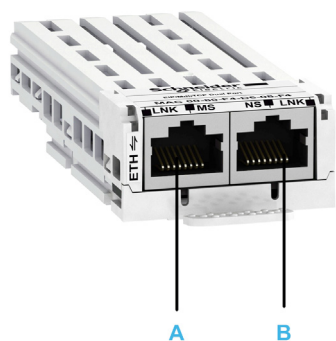

| Item | Description | Comment        |
|------|-------------|----------------|
| A    | Port A      | RJ45 connector |
| B    | Port B      | RJ45 connector |

## Firmware Version

### Compatibility

The VW3A3720 Ethernet module is compatible with ATV600 drives with, at least, V1.5 software version.

## Installation of the Module

### Before Starting

Check that the module catalog number marked on the label is the same as that on the delivery note corresponding to the purchase order.

Remove the fieldbus module from its packaging and check that it has not been damaged in transit.

### Insertion of the Fieldbus Module

The table provides the procedure for insertion of the VW3A3720 Ethernet module in the drive:

| Step | Action                                                                            |
|------|-----------------------------------------------------------------------------------|
| 1    | Ensure that the power is off.                                                     |
| 2    | Locate the fieldbus module slot (A) on the bottom of the control part.            |
| 3    | Add the corresponding sticker on the LED front panel of the drive.                |
| 4    | Insert the module.                                                                |
| 5    | Check that the module is correctly inserted and locked mechanically in the drive. |

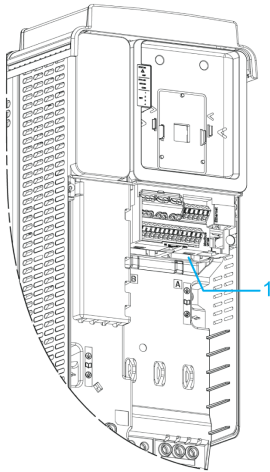

1 Slot A

### Removal of the Fieldbus Module

The table provides the procedure for removal of the VW3A3720 Ethernet module option module from the drive:

| Step | Action                                                 |
|------|--------------------------------------------------------|
| 1    | Ensure that the power is off.                          |
| 2    | Press the strip.                                       |
| 3    | Remove the module while maintaining the strip pressed, |

## Electrical Installation

### Pin Layout

The VW3A3720 Ethernet module is equipped with 2 RJ45 female sockets for the Ethernet connection.

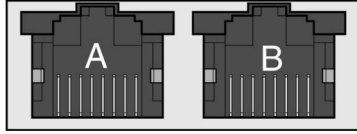

8 7 6 5 4 3 2 1 8 7 6 5 4 3 2 1

The table provides the pin out details of each RJ45 connector:

| Pin | Signal | Meaning                  |
|-----|--------|--------------------------|
| 1   | Tx+    | Ethernet transmit line + |
| 2   | Tx-    | Ethernet transmit line – |
| 3   | Rx+    | Ethernet receive line +  |
| 4   | –      | –                        |
| 5   | –      | –                        |
| 6   | Rx-    | Ethernet receive line –  |
| 7   | –      | –                        |
| 8   | –      | –                        |

### Cable Specification

Cable specifications are as follows:

- Minimum Cat 5e,
- Use equipotential bonding conductors (100 BASE-TX, category 5e or industrial Ethernet fast connect)
- Connector RJ45, no crossover cable
- Shield: both ends grounded
- Twisted-pair cable
- Verify that wiring, cables, and connected interfaces meet the PELV requirements.
- Maximum cable length per segment = 100 m (328 ft) / 6 plugs

**NOTE:** RSTP function is not compatible with half duplex configuration. All devices involved in the RSTP topology shall be RSTP capable and configured.

## Cable Routing Practice

### Installation Topology

The Ethernet adapter enables several wiring solutions:

- Daisy chain and/or Star topology

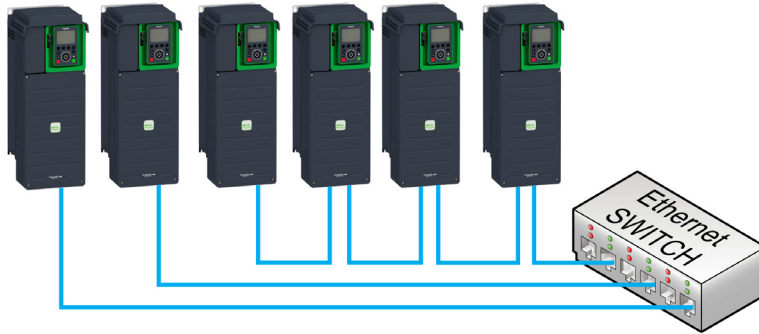

**NOTE:** In daisy chain topology, if one drive is turned off, an **[Fieldbus Com Interrupt] C n F** error is triggered in the other drives connected to the same topology. To keep the integrity of Ethernet daisy chain network when one or more drives are powered off, add an external permanent 24VDC supply to the control block of the drive.

- Redundant ring topology with RSTP (with an RSTP switch)

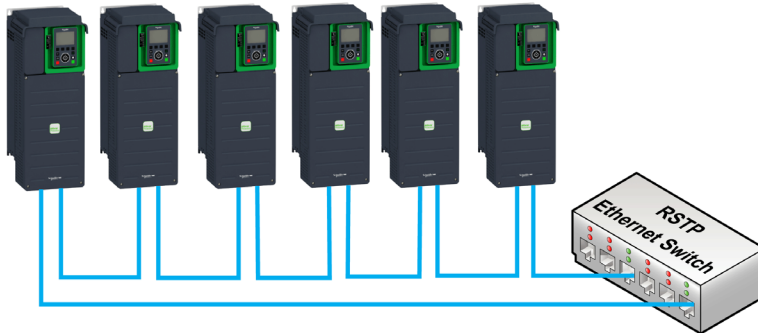

- Redundant ring topology with RSTP (with a RSTP PLC)

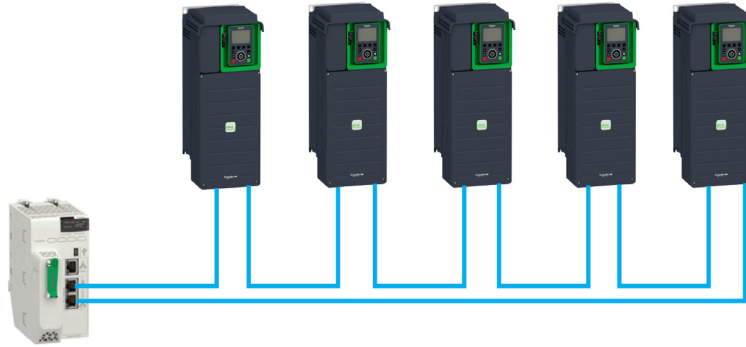

- Redundant star topology with RSTP

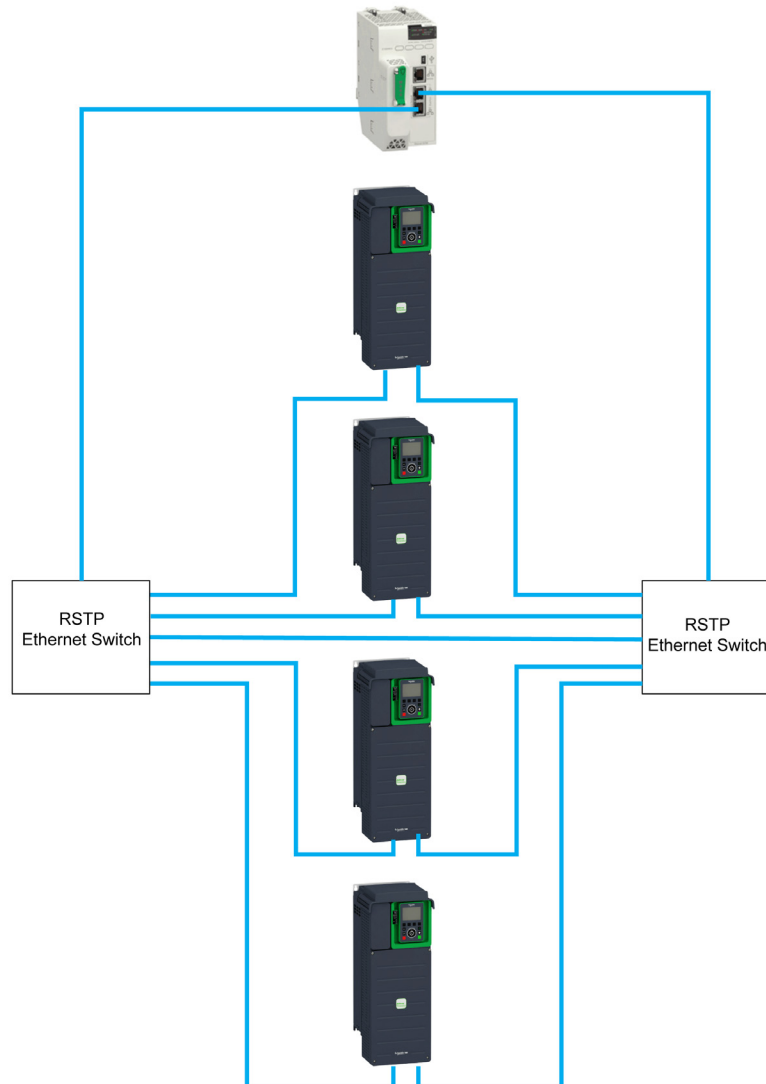

The following figure shows the direct connection between the drive and PC.



---

# Chapter 4

## Software Setup

---

### What Is in This Chapter?

This chapter contains the following sections:

| Section | Topic                                       | Page |
|---------|---------------------------------------------|------|
| 4.1     | Basic Settings                              | 70   |
| 4.2     | Additional Settings                         | 91   |
| 4.3     | Fast Device Replacement                     | 100  |
| 4.4     | Communication Profile                       | 108  |
| 4.5     | Embedded Webserver                          | 125  |
| 4.6     | Fieldbus Integration Using Unity Pro (M580) | 132  |

## Section 4.1

### Basic Settings

#### What Is in This Section?

This section contains the following topics:

| Topic                                                           | Page |
|-----------------------------------------------------------------|------|
| IP Parameter Settings                                           | 71   |
| [Device Name] <i>P R n</i>                                      | 72   |
| [ETH Option IP Mode] <i>, n 1 0</i>                             | 73   |
| [Eth Option IP] <i>, c 1 1 , c 1 2 , c 1 3 , c 1 4</i>          | 74   |
| [Eth Option Subnet Mask] <i>, n 1 1 , n 1 2 , n 1 3 , n 1 4</i> | 75   |
| [Eth Option Gate Add] <i>, G 1 1 , G 1 2 , G 1 3 , G 1 4</i>    | 76   |
| [Enable FDR] <i>F d V 1</i>                                     | 77   |
| [FDR Action] <i>F d R 1</i>                                     | 78   |
| [FDR Operating State] <i>F d S 1</i>                            | 79   |
| [FDR Error Status] <i>F d r 1</i>                               | 80   |
| [MAC @] <i>n R C a</i>                                          | 81   |
| [ETH opt Rx frames] <i>E r X a</i>                              | 82   |
| [ETH opt Tx frames] <i>E t X a</i>                              | 83   |
| [ETH opt error frames] <i>E E r a</i>                           | 84   |
| [Actual rate] <i>R r d</i>                                      | 85   |
| [Enable Webserver] <i>E W E</i>                                 | 86   |
| [Reset OptWeb Passwd] <i>r W P D</i>                            | 87   |
| [Com. Module cmd.] <i>C n d 3</i>                               | 88   |
| [Com. Module Ref Freq] <i>L F r 3</i>                           | 89   |
| [Ethernet Timeout] <i>t t a b</i>                               | 90   |

## IP Parameter Settings

### Assigning IP Parameters

If not using IPV6 functionalities for DWPS, following parameters shall be configured:

- The drive IP address.
- The subnet mask.
- The gateway IP address.

These IP addresses can be entered using the display terminal, the embedded webserver, or the DTM-based PC software.

They can be also provided by:

- A BOOTP server (correspondence between the MAC address and the IP addresses).
- Or a DHCP server (correspondence between device name **[DEVICE NAME] P A n** and the IP addresses).

If an IP address other than 0.0.0.0 has been entered manually, assignment using a server is disabled. Regardless of the type of IP address assignment, if the address is modified, then the IP address is effective the next time the drive is turned on (control voltage if a separate power supply is being used).

### Entering IP Parameters in the Display Terminal

In the **[Communication] C o n -**, **[Comm parameters] C n P -** menu and **[Eth Module Config] E t o -** submenu, enter the following IP addresses:

- **[Eth Option IP]** , C 1 1 , C 1 2 , C 1 3 , C 1 4
- **[ETH Option Subnet Mask]** , n 1 1 , n 1 2 , n 1 3 , n 1 4 ,
- **[Eth Option Gate Add]** , G 1 1 , G 1 2 , G 1 3 , G 1 4 .

If this address is modified, the new IP address entered is displayed.

### Configuring BOOTP

The BOOTP service is used to assign IP addresses based on the MAC address. The MAC address consisting of 6 hexadecimal digits (MM-MM-MM-XX-XX-XX) must be entered in the BOOTP server. The MAC address appears on the fieldbus adapter dedicated menu on the display terminal.

In the **[Communication] C o n -**, **[Comm parameters] C n P -** menu and **[Eth Module Config] E t o -** submenu:

- Leave the IP address **[Eth Option IP]** , C 1 1 , C 1 2 , C 1 3 , C 1 4 at the value **[0.0.0.0] 0 0 0 0**.
- Do not enable the FDR service.

### Configuring DHCP

The DHCP service is used to assign IP addresses and FDR configuration file path based on the device name **[DEVICE NAME] P A n**.

The device name consisting of an alphanumeric string must be entered in both the DHCP server and the drive.

In the **[Communication] C o n -**, **[Comm parameters] C n P -** menu and **[Eth Module Config] E t o -** submenu, enter the **[DEVICE NAME] P A n**

## [Device Name] P R n

### About This Parameter

This parameter is used set the device name.

### Access

This parameter is accessible via [Communication] C o n - , [Comm parameters] C n P - menu and [Eth Module Config] E t o - submenu.

This is a read/write parameter

### Possible Settings

The FDR (Fast Device Replacement) service is based on identification of the device by a **Device Name**. In the case of the Altivar drive, this is represented by the [Device Name] P R n parameter. Verify that all the network devices have different **Device Name**.

**NOTE:** The [Device Name] P R n is common for both Ethernet interfaces.

## [ETH Option IP Mode ] , Π I □

### About This Parameter

This parameter is used to select the IP address assignment method.

### Access

This parameter is accessible via **[Communication] C □ Π -** , **[Comm parameters] C Π P -** menu and **[Eth Module Config] E E □ -** submenu.

This is a read/write parameter

The parameter number is 64450.

### Possible Settings

The table presents the parameter settings:

| Settings | Code    | Value | Description                                                                                                   |
|----------|---------|-------|---------------------------------------------------------------------------------------------------------------|
| [Fixed]  | Π Π η υ | 0     | Manually set the IP address.                                                                                  |
| [BOOTP]  | β ο ο ε | 1     | Automatically gets the IP address from the Bootp or DHCP server using the MAC address.                        |
| [DHCP]   | δ Η C P | 2     | Automatically gets the IP address from the DHCP server using the device name.<br><b>Factory setting:</b> DHCP |

## [Eth Option IP] ,C 11 ,C 12 ,C 13 ,C 14

### About This Parameter

This parameter is used to set the IP address and can be edited only when the IP mode is set to fixed address.

### Access

This parameter is accessible via [Communication] C o n - , [Comm parameters] C n P - menu and [Eth Module Config] E t o - submenu.

This is a read/write parameter

The parameter number for IC11 is 64451

The parameter number for IC12 is 64452

The parameter number for IC13 is 64453

The parameter number for IC14 is 64454

### Possible Settings

The table presents the parameter settings:

| Settings          | Code | Value   | Description                |
|-------------------|------|---------|----------------------------|
| [139.160.069.241] | 139  | 0...255 | First byte of IP address.  |
|                   | 160  | 0...255 | Second byte of IP address. |
|                   | 069  | 0...255 | Third byte of IP address.  |
|                   | 241  | 0...255 | Fourth byte of IP address. |

## [Eth Option Subnet Mask] , 111 , 112 , 113 , 114

### About This Parameter

This parameter is used to set the IP subnet mask and can be edited only when IP mode is set to fixed address.

### Access

This parameter is accessible via **[Communication] C O N -** , **[Comm parameters] C N P -** menu and **[Eth Module Config] E E O -** submenu.

This is a read/write parameter

The parameter number for IM11 is 64455

The parameter number for IM12 is 64456

The parameter number for IM13 is 64457

The parameter number for IM14 is 64458

### Possible Settings

The table presents the parameter settings:

| Settings        | Code  | Value   | Description             |
|-----------------|-------|---------|-------------------------|
| [255.255.254.0] | 2 5 5 | 0...255 | First byte of IP Mask.  |
|                 | 2 5 5 | 0...255 | Second byte of IP Mask. |
|                 | 2 5 4 | 0...255 | Third byte of IP Mask.  |
|                 | 0     | 0...255 | Fourth byte of IP Mask. |

## [Eth Option Gate Add] ,G 11 ,G 12 ,G 13 ,G 14

### About This Parameter

This parameter is used to set the default gateway address and can be edited only IP mode is set to fixed address.

### Access

This parameter is accessible via [Communication] C o n - , [Comm parameters] C n P - menu and [Eth Module Config] E t o - submenu.

This is a read/write parameter

The parameter number for IG11 is 64459

The parameter number for IG12 is 64460

The parameter number for is IG13 64461

The parameter number for is IG14 64462

### Possible Settings

The table presents the parameter settings:

| Settings  | Code | Value   | Description               |
|-----------|------|---------|---------------------------|
| [0.0.0.0] | 0    | 0...255 | First byte of IP gateway. |
|           | 1    | 0...255 | Second byte of IP gateway |
|           | 2    | 0...255 | Third byte of IP gateway  |
|           | 3    | 0...255 | Fourth byte of IP gateway |

## [Enable FDR] F d V I

### About This Parameter

This parameter is used to enable or disable the FDR service.

### Access

This parameter is accessible via **[Communication] C o N -**, **[Comm parameters] C N P -** menu, **[Eth Module Config] E t o -** submenu and **[Fast Device Replacement] F d r -** submenu.

This is a read/write parameter.

The parameter number is 64445

This parameter can be accessed if **[ETH Option IP Mode] , n i D** is set to **[DHCP] d H C P**

### Possible Settings

The table presents the parameter settings:

| Settings | Code  | Value | Description                |
|----------|-------|-------|----------------------------|
| [No]     | n o   | 0     | No: FDR service disabled   |
| [Yes]    | y e s | 1     | Yes: FDR service enabled   |
|          |       |       | <b>Factory setting:</b> No |

## [FDR Action] F d R I

### About This Parameter

This parameter is used to select the FDR action that needs to be performed.

### Access

This parameter is accessible via [Communication] C o m - , [Comm parameters] C n P - menu, [Eth Module Config] E t o - submenu and [Fast Device Replacement] F d r - submenu.

This is a read/write parameter.

The parameter number is 64444

This parameter can be accessed if [ETH Option IP Mode] , n i D is set to [DHCP] d H C P

### Possible Settings

The table presents the parameter settings:

| Settings     | Code    | Value | Description                  |
|--------------|---------|-------|------------------------------|
| [NOT ACTIVE] | , d L E | 0     | Not active: No FDR action    |
| [SAVE]       | S A V E | 1     | Save: FDR save command       |
| [REST]       | r E S T | 2     | Restore: FDR restore command |

**[FDR Operating State] F d S I****About This Parameter**

This parameter is used to display the FDR operating state.

**Access**

This parameter is accessible via **[Communication] C o m -**, **[Comm parameters] C n P -** menu, **[Eth Module Config] E t o -** submenu and **[Fast Device Replacement] F d r -** submenu.

This is a read-only parameter.

The parameter number is 64443

This parameter can be accessed if **[ETH Option IP Mode] , n I D** is set to **[DHCP] d H C P**

**Possible Settings**

The table presents the parameter settings:

| Settings                 | Code    | Value | Description                                  |
|--------------------------|---------|-------|----------------------------------------------|
| [Initialization]         | i n i t | 0     | INIT: Initialization                         |
| [Not Active]             | i d L E | 1     | IDLE: Function not active                    |
| [Operational]            | o P E   | 2     | OPE: Operational                             |
| [Ready]                  | r d Y   | 4     | RDY: Ready                                   |
| [IP Configuration]       | i P C   | 5     | IPC: IP configuration                        |
| [Not Configured]         | u n C F | 7     | UNCF: Function not configured                |
| [Reading Configuration]  | G E T   | 8     | GET: Download the current configuration      |
| [Writing Configuration]  | S E T   | 9     | SET: Save the current configuration          |
| [Applying Configuration] | A P P   | 10    | APP: Applying the configuration to the drive |

**[FDR Error Status] F d r l**

**About This Parameter**

This parameter is used to display the FDR error status.

**Access**

This parameter is accessible via **[Communication] C o m -** , **[Comm parameters] C n P -** menu, **[Eth Module Config] E t o -** submenu and **[Fast Device Replacement] F d r -** submenu.

This is a read-only parameter.

The parameter number is 64442

This parameter can be accessed if **[ETH Option IP Mode] , n I D** is set to **[DHCP] d H C P**

**Possible Settings**

The table presents the parameter settings:

| Settings                     | Code    | Value | Description                                         |
|------------------------------|---------|-------|-----------------------------------------------------|
| [No Error]                   | n o     | 0     | NO: No error                                        |
| [Service Timeout]            | t o u t | 1     | TOUT: Server timeout                                |
| [Server No File]             | S n F   | 2     | SNF: No file on server                              |
| [Server Corrupt File]        | C r P t | 3     | CRPT: Corrupted file on server                      |
| [Server Empty File]          | E P t Y | 4     | EPTY: Empty file on server                          |
| [Drive Invalid File]         | H i n V | 5     | HINV: Invalid file on drive                         |
| [CRC Error]                  | C r C   | 6     | CRC: CRC error                                      |
| [Version Incompatibility]    | V r n   | 7     | VRM: Version incompatibility between drive and file |
| [Drive No File]              | H n F   | 9     | HNF: No file on drive                               |
| [Server Reading Size]        | S i Z E | 10    | SIZE: File size reading error on server             |
| [Drive Opening File]         | o P E n | 11    | OPEN: Drive cannot open the file                    |
| [Drive Reading File]         | r E A d | 12    | READ: Drive cannot read the file                    |
| [Incompatibility]            | S C n t | 13    | SCNT: File incompatibility                          |
| [Drive Invalid Name]         | n i n V | 14    | NINV: Drive name is invalid                         |
| [Server Incorrect File Size] | F S i Z | 15    | FSIZ: Incorrect file size on server                 |
| [Drive Writing File]         | H W F   | 16    | HWF: Drive cannot write the file                    |
| [Server Writing File]        | S W F   | 17    | SWF: Server cannot write the file                   |

**[MAC @] П П С □****About This Parameter**

This parameter displays the MAC address of the device.

**Access**

This parameter is accessible via **[Display] П □ □ -** , **[Communication map] С П П -** menu and **[Ethernet Module Diag] П Е Е -**

This is a read-only parameter

**Possible Settings**

The table presents the parameter settings:

| Settings            | Code                              | Value             | Description |
|---------------------|-----------------------------------|-------------------|-------------|
| [MM-MM-MM-XX-XX-XX] | П П - П П - П П - X X - X X - X X | MM-MM-MM-XX-XX-XX | MAC address |

## [ETH opt Rx frames] E r X 0

### About This Parameter

This parameter displays the Ethernet module received frames counter

### Access

This parameter is accessible via **[Display] П 0 П -** , **[Communication map] C П П -** menu and **[Ethernet Module Diag] П E E -** submenu.

This is a read-only parameter

The parameter numbers is 64466

---

## [ETH opt Tx frames] E E X □

### About This Parameter

This parameter displays the Ethernet adapter transmitted frames counter

### Access

This parameter is accessible via **[Display] П □ □ -** , **[Communication map] □ П П -** menu and **[Ethernet Module Diag] П E E -** submenu.

This is a read-only parameter

The parameter numbers is 64468.

## [ETH opt error frames] E E r o

### About This Parameter

This parameter displays the Ethernet adapter error frames counter

### Access

This parameter is accessible via **[Display] П o n -** , **[Communication map] C П П -** menu and **[Ethernet Module Diag] П E E -** submenu.

This is a read-only parameter

The parameter numbers is 64470

**[Actual rate]** *А р д***About This Parameter**

This parameter displays the Ethernet adapter actual rate.

**Access**

This parameter is accessible via **[Display]** *П о н* - , **[Communication map]** *С П П* - menu and **[Ethernet Module Diag]** *П Е Е* - submenu.

This is a read-only parameter

The parameter numbers is 64413

**Possible Settings**

The table presents the parameter settings:

| Settings     | Code           | Value | Description                                                             |
|--------------|----------------|-------|-------------------------------------------------------------------------|
| [Auto]       | <i>А у т о</i> | Auto  | Data rate is auto detected depending on the first data packet received. |
| [10M. full]  | <i>10 F</i>    | 10 F  | Data rate is set to 10 Mbit/s full                                      |
| [10M. half]  | <i>10 H</i>    | 10 H  | Data rate is set to 10 Mbit/s half                                      |
| [100M. full] | <i>100 F</i>   | 100 F | Data rate is set to 100 Mbit/s full                                     |
| [100M. half] | <i>100 H</i>   | 100 H | Data rate is set to 100 Mbit/s half                                     |
|              |                |       | <b>Factory setting:</b> Auto                                            |

## [Enable Webserver] *E W E*

### About This Parameter

This parameter is used to manage the fieldbus adapter Web services.

### Access

This parameter is accessible via **[My preferences] *Π Υ Ρ*** - menu and **[Webserver] *W B S*** - submenu.

This is a read/write parameter

The parameter numbers is 64264.

### Possible Settings

The table presents the parameter settings:

| Settings | Code         | Value | Description                                         |
|----------|--------------|-------|-----------------------------------------------------|
| [No]     | <i>n o</i>   | 0     | Web services disabled                               |
| [Yes]    | <i>Y E S</i> | 1     | Web services enabled<br><b>Factory setting:</b> Yes |

## [Reset OptWeb Passwd] *r W P 0*

### About This Parameter

This parameter is used to manage the set to factory value the Ethernet webserver settings, including the password.

### Access

This parameter is accessible via **[My preferences] *M Y P*** - menu and **[Webserver] *W B S*** - submenu.

This is a read/write parameter

### Possible Settings

The table presents the parameter settings:

| Settings | Code         | Value | Description                                                                                                                                                                                                                  |
|----------|--------------|-------|------------------------------------------------------------------------------------------------------------------------------------------------------------------------------------------------------------------------------|
| [No]     | <i>n 0</i>   | 0     | Reset of the adapter webserver password not requested                                                                                                                                                                        |
| [Yes]    | <i>y E 5</i> | 1     | Reset of the adapter webserver password requested                                                                                                                                                                            |
|          |              |       | <b>NOTE:</b> <ul style="list-style-type: none"> <li>• The parameter is set to <b>[No]</b> when the operation is done</li> <li>• The webserver must be refreshed in browser to take into account the new password.</li> </ul> |

## [Com. Module cmd.] [ П Д Э ]

### About This Parameter

This parameter displays the command word built with Ethernet module source (same as CMD).

### Access

This parameter is accessible via **[Display] П Д Э -** , **[Communication map] [ П П -** menu and **[Command word image] [ W , -** submenu.

This is a read-only parameter

The parameter numbers is 8513

---

## [Com. Module Ref Freq] *L F r 3*

### About This Parameter

This parameter displays the reference frequency built with Ethernet module source (same as LFr).

### Access

This parameter is accessible via **[Display] *Π ο η*** - , **[Communication map] *Ε Π Π*** - menu and **[Command word image] *Ε W ι*** - submenu.

This is a read-only parameter

The parameter numbers is 8523

## [Ethernet Timeout] *t t o b*

### About This Parameter

This parameter is used to set the Ethernet timeout.

### Access

This parameter is accessible via fieldbus using the Modbus address.

This is a read/write parameter

The parameter number is 64415.

### Possible Settings

The table presents the parameter settings:

| Settings     | Description                    |
|--------------|--------------------------------|
| 0.1...30 sec | <b>Factory setting:</b> 10 sec |

---

## Section 4.2

### Additional Settings

---

#### What Is in This Section?

This section contains the following topics:

| Topic                    | Page |
|--------------------------|------|
| FDR Settings             | 92   |
| RSTP Settings            | 93   |
| Configuring I/O Scanning | 95   |
| DNS Settings             | 96   |
| SNTP Settings            | 97   |
| SNMP Settings            | 98   |

## FDR Settings

### Access

The parameters are accessible via the webserver or the DTM-based PC software

### FDR Configuration

The following figure shows FDR settings via webserver:

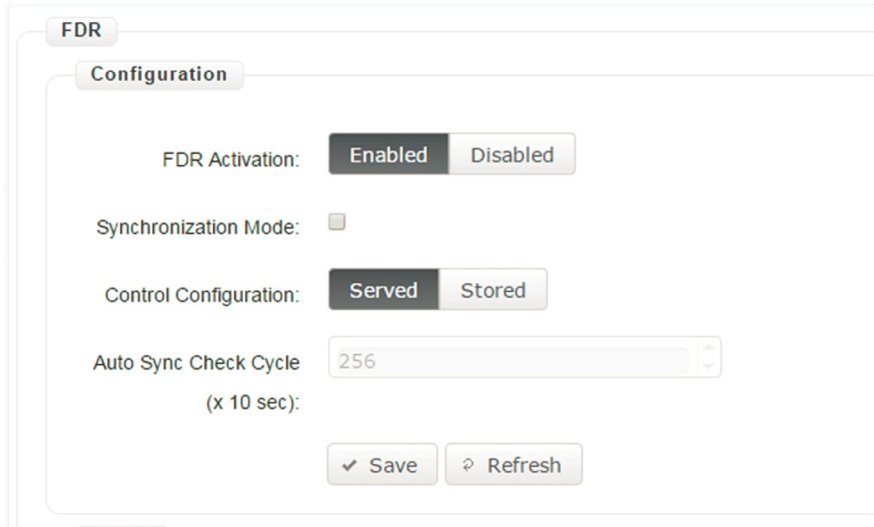

The table presents the **FDR Configuration** settings:

| Parameter                           | Description                                                                                                                                                                                                           | Settings                                                                                                                                                                                      |
|-------------------------------------|-----------------------------------------------------------------------------------------------------------------------------------------------------------------------------------------------------------------------|-----------------------------------------------------------------------------------------------------------------------------------------------------------------------------------------------|
| <b>FDR Activation</b>               | This parameter is used to enable or disable the FDR service<br><b>NOTE:</b> You can enable FDR only if the <b>IP assignment mode</b> selected is DHCP.                                                                | <b>Enabled:</b> FDR service enabled<br><b>Disabled:</b> FDR service disabled.<br><b>Factory setting:</b> Enabled                                                                              |
| <b>Control Configuration</b>        | This parameter is used to select the server or local configuration.                                                                                                                                                   | <b>Served:</b> Transfers the configuration file from server to drive at power-up.<br><b>Stored:</b> uses the configuration stored in the drive at power-up.<br><b>Factory setting:</b> served |
| <b>Automatic Syncho Cycle (Sec)</b> | Allows you to select the interval for periodic synchronization of the drive with the FDR server.<br><b>NOTE:</b> You can configure automatic Synchro cycle only if <b>Synchronization mode</b> check box is selected. | 10...655350 sec<br><b>Factory setting:</b> 2560 sec                                                                                                                                           |

## RSTP Settings

### Access

The parameters are accessible via the DTM-based PC software.

### Bridge Settings

The following figure shows the bridge settings using the DTM:

The screenshot shows the 'Bridge' configuration window. At the top left, there is a dropdown arrow and the text 'Bridge'. Below this, there is a list of settings:

- Enable RSTP**: A checkbox that is checked.
- Status**: A dropdown menu set to 'Enable'.
- Bridge Priority**: A dropdown menu set to '0x8000'.
- Hello Time(s)**: A dropdown menu set to '2Second'.
- Max age time (6-40s)**: A dropdown menu set to '36Second'.

The table presents the **Bridge** configuration

| Parameters                   | Description                                                                                                                                                                                                                                                                                                                                                                                                                                        | Settings                                                                                                                                            |                                                                                                                                                                                           |
|------------------------------|----------------------------------------------------------------------------------------------------------------------------------------------------------------------------------------------------------------------------------------------------------------------------------------------------------------------------------------------------------------------------------------------------------------------------------------------------|-----------------------------------------------------------------------------------------------------------------------------------------------------|-------------------------------------------------------------------------------------------------------------------------------------------------------------------------------------------|
| <b>Enable RSTP</b>           | Allows you to enable or disable the RSTP                                                                                                                                                                                                                                                                                                                                                                                                           | To enable RSTP, select the <b>Enable RSTP</b> check box.                                                                                            |                                                                                                                                                                                           |
| <b>Status</b>                | Allows you to enable or disable the RSTP bridge.                                                                                                                                                                                                                                                                                                                                                                                                   | <b>Enabled:</b> Enables the use of Rapid Spanning-Tree Protocol (RSTP).<br><b>Disabled:</b> Disables the use of Rapid Spanning-Tree Protocol (RSTP) |                                                                                                                                                                                           |
| <b>Bridge Priority</b>       | The bridge priority is used to control which bridge is elected as the root bridge. Bridge with the smallest (lowest) bridge ID is elected as the root bridge. Bridge ID consists of the configurable priority and the MAC address of the bridge. To compare 2 bridge ids, bridge priorities are compared first. If the bridge priorities are equal, then the MAC addresses are compared. The bridge priority can be set only in increments of 4096 | 0<br>4096<br>8192<br>12288<br>16384<br>20480<br>24576<br>28672<br>32768<br>36864<br>40960<br>45056<br>49152<br>53248<br>57344<br>61440              | 0 hex<br>1000 hex<br>2000 hex<br>3000 hex<br>4000 hex<br>5000 hex<br>6000 hex<br>7000 hex<br>8000 hex<br>9000 hex<br>A000 hex<br>B000 hex<br>C000 hex<br>D000 hex<br>E000 hex<br>F000 hex |
| <b>Hello Time(S)</b>         | The hello time parameter corresponds to the time interval at which the root bridge transmits configuration Bridge Protocol Data Units (BPDU)s.                                                                                                                                                                                                                                                                                                     | 1...10 sec                                                                                                                                          |                                                                                                                                                                                           |
| <b>Max age time (6-40 s)</b> | The maximum age time correspond to the maximum expected arrival time of hello BPDUs. If the timer expires, the bridge detects a communication interruption to the root bridge and initiates a topology convergence. The maximum age timer should be longer than the configured hello time.                                                                                                                                                         | 6...40 sec                                                                                                                                          |                                                                                                                                                                                           |

**Ports Configuration**

The following figure shows the port settings:

— Ports

|                    |          |
|--------------------|----------|
| Port 1 priority :  | 128      |
| Port 1 path cost : | 0        |
| Port 1 select :    | EdgePort |
| <hr/>              |          |
| Port 2 priority :  | 128      |
| Port 2 path cost : | 0        |
| Port 2 select :    | EdgePort |

The table provides the **Ports** settings

| Parameters            | Description                                                                                                                                                                                                               | Settings                                                                                                                                                                                                  |
|-----------------------|---------------------------------------------------------------------------------------------------------------------------------------------------------------------------------------------------------------------------|-----------------------------------------------------------------------------------------------------------------------------------------------------------------------------------------------------------|
| <b>Port Priority</b>  | Allows you to define the priority of the interface to the other going to same subnet.                                                                                                                                     | 0...240<br><b>NOTE:</b><br><ul style="list-style-type: none"> <li>• The port priority can be set only in increments of 16</li> <li>• Drive takes the value in account after a product restart.</li> </ul> |
| <b>Port Path Cost</b> | Allows you to define the cost of sending spanning tree traffic through the interface. RSTP uses path cost to determine the topology with the smallest total path cost between each point of the tree and the root bridge. | 0...1,569,325,055<br><b>NOTE:</b> If the port path cost is set to 0 (auto), the path cost is based on the port link speed maximum, for details see the following table.                                   |
| <b>Port Select</b>    | Allows you to select the type of ports. With the port types defined, RSTP can quickly reconfigure a network when a change in network topology is detected.                                                                | <b>RSTP Port</b><br><b>Edge Port</b>                                                                                                                                                                      |

Table provides the value of the path cost based on the port link maximum speed

| Port Link Maximum Speed                | Automatic Path Cost |
|----------------------------------------|---------------------|
| 10 Gb/s (Not supported by the adapter) | 2000                |
| 1 Gb/S (Not supported by the adapter)  | 20000               |
| 100 Mb/s                               | 200000              |
| 10 Mb/s                                | 2000000             |

---

## Configuring I/O Scanning

### Description

The drive I/O scanning service can be enabled or disabled with the DTM-based PC software.

It is not possible to modify the assignment of the I/O scanning periodic variables using the display terminal. To configure I/O scanning, use the DTM-based PC software.

## DNS Settings

### Description

The Domain Name System (DNS) is a distributed naming system for devices connected to the network. It translates domain names to IP addresses for locating the devices easily on the network.

### DNS Configuration

The DNS configuration can be done using the DTM-based PC software. The following figure shows the DNS configuration window:

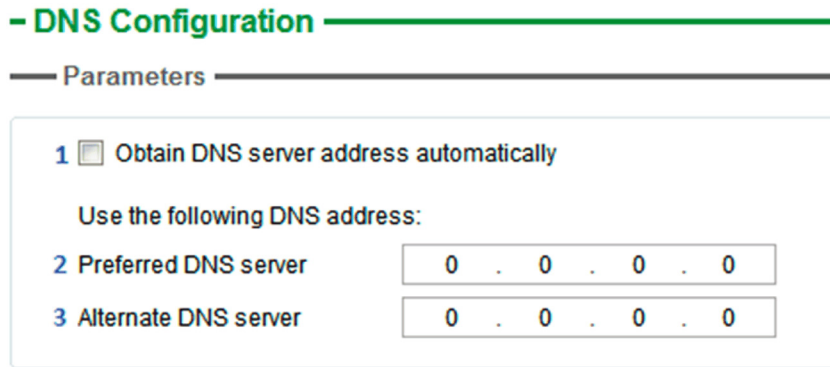

The table presents the **DNS Configuration** settings:

| Item | Description                                                                                                                                                              |
|------|--------------------------------------------------------------------------------------------------------------------------------------------------------------------------|
| 1    | <b>Obtain DNS Server address automatically:</b> When checked, the function is enabled and allows getting automatically the IP address from the DNS server.               |
| 2    | <b>Preferred DNS server:</b> Enter the IP address of the preferred DNS server.                                                                                           |
| 3    | <b>Alternate DNS server:</b> Enter the IP address of the alternate DNS server.<br><b>NOTE:</b> The alternate IP address is used only if the first server is unavailable. |

**NOTE:** The changes must be applied to the module configuration by clicking the  button.

## SNTP Settings

### Description

The Simple Network Time Protocol (SNTP) is networking protocol for clock synchronization of devices connected to the network.

### SNTP Configuration

The SNTP configuration can be done using the DTM-based PC software.

The following figure shows the SNTP Configuration window:

— **SNTP Configuration** —

---

— SNTP Settings —

|   |                     |               |
|---|---------------------|---------------|
| 1 | SNTP                | Enabled       |
| 2 | Server 1 IP Address | 0 . 0 . 0 . 0 |
| 3 | Server 2 IP Address | 0 . 0 . 0 . 0 |
| 4 | Polling Interval    | 1 minute      |

---

— Local Time —

|   |              |                       |
|---|--------------|-----------------------|
| a | Current Date | samedi 1 janvier 2000 |
| b | Current Time | 00:00:00              |

The **SNTP Configuration** window is divided in 2 zones:

- **SNTP Settings**
- **Local Time**

The table presents the **SNTP settings**:

| Item | Description                                                                                                                                                                     |
|------|---------------------------------------------------------------------------------------------------------------------------------------------------------------------------------|
| 1    | <b>Enabled:</b> Enables SNTP service.<br><b>Disabled:</b> Disables SNTP service.                                                                                                |
| 2    | <b>Server 1 IP Address:</b> Enter the IP address of the first preferred SNTP server.                                                                                            |
| 3    | <b>Server 2 IP Address:</b> Enter the IP address of the second preferred SNTP server.<br><b>NOTE:</b> This IP address is used for SNTP only if the first server is unavailable. |
| 4    | <b>Polling Interval:</b> Allows you to select the scanning interval for checking the time change.                                                                               |

The table presents the **Local Time** settings:

| Item | Description                                                |
|------|------------------------------------------------------------|
| a    | <b>Current Date:</b> Allows you to enter the current date  |
| b    | <b>Current Time:</b> Allows you to select the current time |

**NOTE:** The changes must be applied to the module configuration by clicking the  button.

## SNMP Settings

### Description

Simple Network Management Protocol (SNMP) is an internet-standard protocol used to manage devices on IP networks.

It is used for collecting and organizing information about the devices on the network.

### SNMP Configuration

The SNMP configuration can be done using the DTM-based PC software.

The following figure shows the Sntp Configuration window:

The screenshot shows the 'SNMP Configuration' window with the following fields:

- Manager's IP Address:**
  - 1a Manager 1: 0 . 0 . 0 . 0
  - 2a Manager 2: 0 . 0 . 0 . 0
- Agent:**
  - 1b System Name: ATV6xx
  - 2b System Location: My Location
  - 3b System Contact: Schneider Electric
- Community Names:**
  - 1c Get: public
  - 2c Set: private
  - 3c Trap: trap
- Enabled Traps:**
  - 1d  Cold Start Trap
  - 2d  Link Down Trap
  - 3d  Link Up Trap
  - 4d  Authentication Failure Trap

The **SNMP Configuration** window is divided in 4 zones:

- **Manager's IP Address**
- **Agent**
- **Community Names**
- **Enabled Traps**

### Manager's IP Address

SNMP manager is a central system used for monitoring and controlling the SNMP agents.

The table presents **Manager's IP Address** settings:

| Item | Description                                                                                                       |
|------|-------------------------------------------------------------------------------------------------------------------|
| 1a   | <b>Manager 1:</b> SNMP manager is a central system, which is used for monitoring and controlling the SNMP agents. |
| 2a   | <b>Manager 2:</b> Enter the IP address of SNMP manager 2.                                                         |

### Agents

Agents are the devices which are connected to the network. The SNMP manager monitors these devices.

The table presents the **Agents** settings:

| Item | Description                                                                                                          |
|------|----------------------------------------------------------------------------------------------------------------------|
| 1b   | <b>System Name:</b> Enter the system name used by the drive.                                                         |
| 2b   | <b>System Location:</b> Enter the system location of the drive.                                                      |
| 3b   | <b>System Contact:</b> Contact point to get the information about the system. Enter the system contact of the drive. |

## Community Names

Community names are used to identify the commands that can be performed by an SNMP manager on a device.

The table presents the **Community Names** settings:

| Item | Description                                                                  |
|------|------------------------------------------------------------------------------|
| 1c   | <b>Get:</b> Requests send from manager to agent to retrieve data.            |
| 2c   | <b>Set:</b> Requests send from manager to agent to change data.              |
| 3c   | <b>Trap:</b> Requests send from manager to agent to find the available data. |

## Enabled Traps

Traps are used to inform the SNMP manager of specific events occurring on device.

The table presents the **Enabled Traps** settings:

| Item | Description                                                                                        |
|------|----------------------------------------------------------------------------------------------------|
| 1d   | <b>Cold Start:</b> The agent reinitialized its configuration tables.                               |
| 2d   | <b>Link Down Trap:</b> A network interface card (NIC) on agent reinitializes.                      |
| 3d   | <b>Link Up Trap:</b> A network interface card (NIC) on agent stops responding.                     |
| 4d   | <b>Authentication Failure Trap:</b> SNMP agent gets a request from an unrecognized community name. |

## Section 4.3

### Fast Device Replacement

---

#### What Is in This Section?

This section contains the following topics:

| Topic                     | Page |
|---------------------------|------|
| Presentation              | 101  |
| Startup Detailed Behavior | 102  |
| FDR Operation Behavior    | 103  |
| Local Configuration       | 104  |
| Downloaded Configuration  | 105  |

## Presentation

### FDR Service

The FDR (Fast Device Replacement) service is used to simplify the maintenance of drives connected to an Ethernet network. In the event of a drive not working correctly, this service automatically reconfigures its replacement.

The new drive (FDR client) retrieves:

- Its IP addresses and the FDR file path from a DHCP server
- The FDR file from an FTP server if the drive is not configured in local configuration

In practice, the DHCP server and the FTP server are the same device (PAC M580, M340 PLC, or dedicated PCs).

The FDR file contains:

- The Ethernet parameters (configuration of I/O scanning, FDR, and so on)
- The drive parameters (drive, functions, application, and so on)

The FDR service is based on identification of the device by a **Device Name**. In the case of the drive, this is represented by the **[DEVICE NAME] P R n** parameter.

The configuration of the FDR service is accessible via embedded webserver or DTM-based software or Graphic Display Terminal.

**NOTE:** Check that all the network devices have different **Device Name**.

The FDR server controls duplication of **Device Name** (it does not assign an IP address that has already been assigned and is active).

If the same IP address is supplied on 2 devices, the second should trigger an IP address duplication (network management detected error which triggers an **[Fieldbus Error] E P F 2** by default).

If the FDR service has been enabled, the Ethernet adapter attempts to restore its IP addresses on each power-up. Each time the procedure has detected error, the Ethernet adapter reiterates its FDR requests (DHCP).

After assigning the Ethernet adapter IP addresses, if the configuration is not downloaded successfully, the Ethernet adapter triggers a **[FDR2 Error] F d r 2**.

## Startup Detailed Behavior

### Presentation

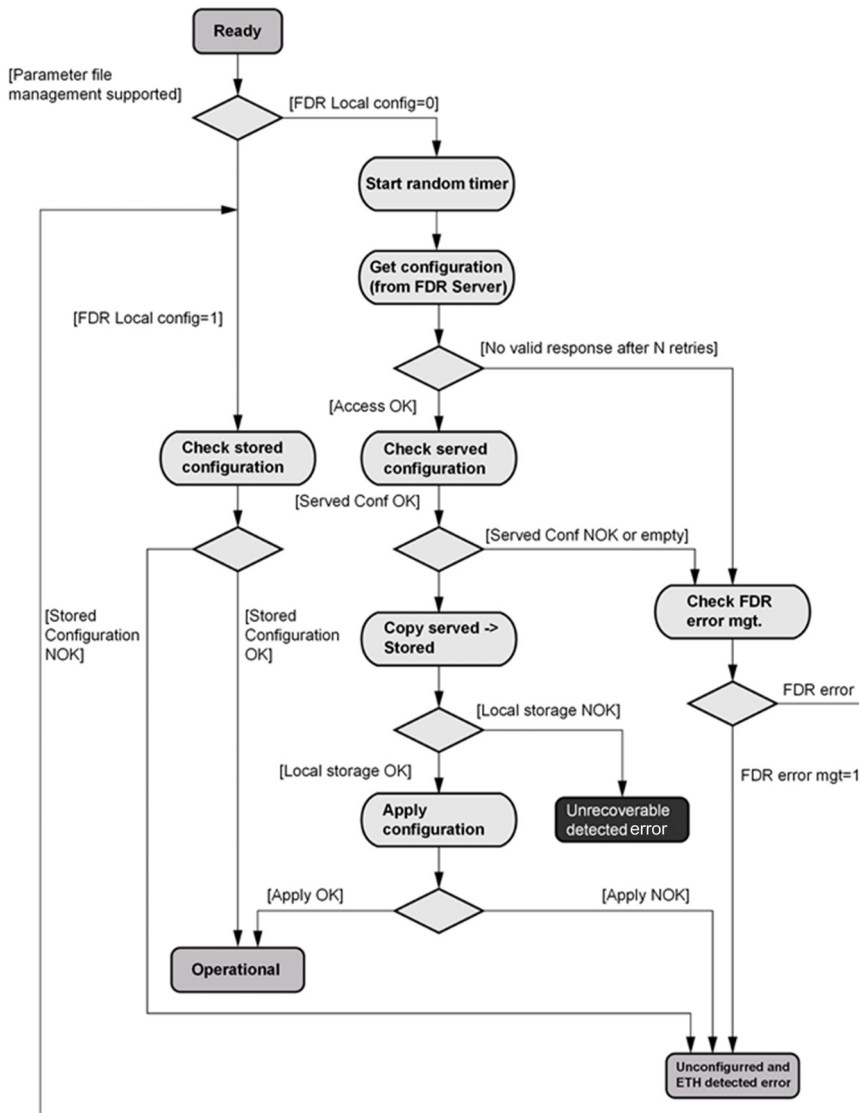

## FDR Operation Behavior

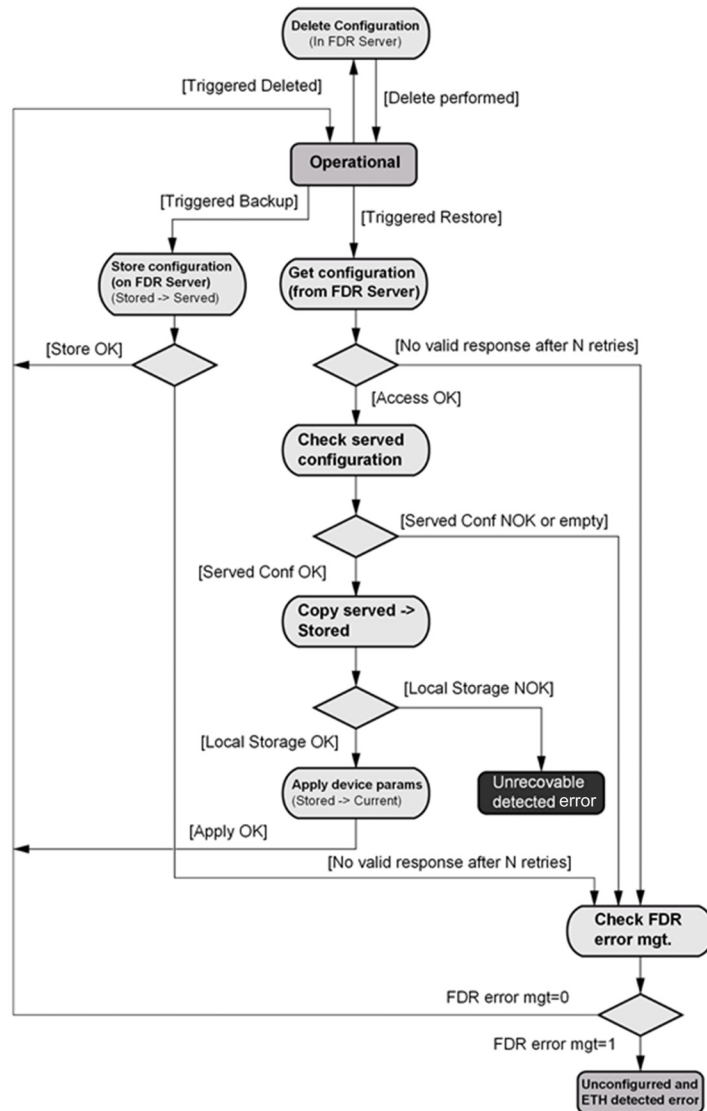

## Local Configuration

### Presentation

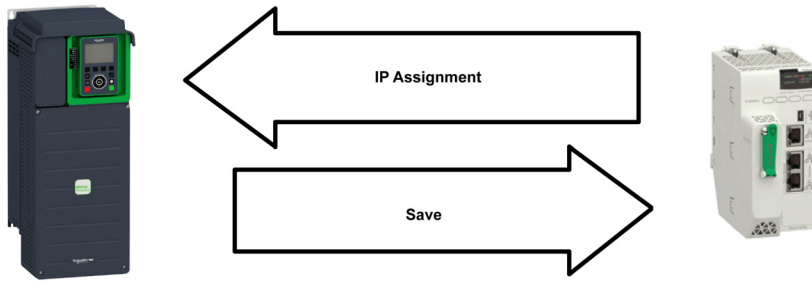

### IP Assignment Save

If the drive parameter configuration is local, the FDR server only assigns the following IP addresses:

- IP address,
- Subnet mask,
- Gateway IP address.

On connection to the network, the drive automatically saves its parameters in the FDR server.

### Drive Connection Procedure

| Step | Action                           | Description                                                                                                                                                                                                                                                                                                                                                                                                                                                                                                                |
|------|----------------------------------|----------------------------------------------------------------------------------------------------------------------------------------------------------------------------------------------------------------------------------------------------------------------------------------------------------------------------------------------------------------------------------------------------------------------------------------------------------------------------------------------------------------------------|
| 1    | Configure the FDR server         | See the PLC manual or the section on software setup using Unity                                                                                                                                                                                                                                                                                                                                                                                                                                                            |
| 2    | Configure the drive              | In the <b>[Communication] C o n -</b> , <b>[Comm parameters] C n P -</b> menu, submenu: <b>[Eth Module Config] E t o -</b><br>Configure <b>[ETH Option IP Mode] i n I D</b><br>Enable the FDR service via webserver or DTM-based software or Graphic Display Terminal.<br>Select local drive configuration with webserver or DTM-based software.<br>Enter the device name, <b>DEVICE NAME</b> , in the <b>[Communication] C o n -</b> , <b>[Comm parameters] C n P -</b> menu, <b>[Eth Module Config] E t o -</b> submenu. |
| 3    | Turn off the drive               | Turn off the drive and then back on again (control voltage supply if a separate power supply is being used), otherwise the device name is not taken into account                                                                                                                                                                                                                                                                                                                                                           |
| 4    | Connect the drive to the network | Connect the drive and the FDR server (PLC) to the Ethernet network                                                                                                                                                                                                                                                                                                                                                                                                                                                         |

## Downloaded Configuration

### Presentation

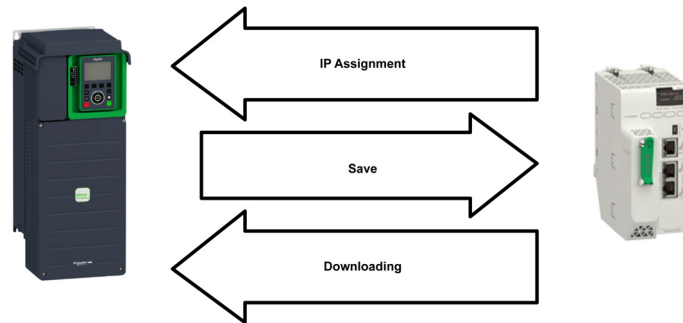

### IP Assignment Save

If the drive parameter configuration has been downloaded, the FDR server assigns the following addresses:

- IP address,
- Subnet mask,
- Gateway IP address,
- FDR server IP address.

### Periodic Saving

Periodic saving of the drive configuration can be configured on the FDR server in either local configuration or downloaded configuration mode

Using the embedded webserver or the DTM-based software:

- Set FDR synchronization to automatic mode
- Set the synchronization cycle time

**NOTE:** Saving too often overburden the fieldbus and adversely affects its performance (factory setting: 2.560 s.).

### Limitations

The FDR service is able to store the current configuration of the drive, but does not provide the possibility to store multi-parameters configurations.

**Drive Parameters (Configuration)**

In the procedure described below, the configuration file is transferred to the FDR server, via the Ethernet network, using a manual save command.

| Step | Action                                            | Description                                                                                                                                                                                                                                                                                                                                                                                                                                                                                                                                                                                                                                                                                                                                                                      |
|------|---------------------------------------------------|----------------------------------------------------------------------------------------------------------------------------------------------------------------------------------------------------------------------------------------------------------------------------------------------------------------------------------------------------------------------------------------------------------------------------------------------------------------------------------------------------------------------------------------------------------------------------------------------------------------------------------------------------------------------------------------------------------------------------------------------------------------------------------|
| 1    | Configure the drive                               | <p>In the <b>[Communication] C o n -</b>, <b>[Comm parameters] C n P -</b> menu, <b>[Eth Module Config] E t o -</b> submenu:</p> <ul style="list-style-type: none"> <li>Leave the IP address <b>[ETH Option IP] , C 1 1 , C 1 2 , C 1 3 , C 1 4</b> at the value <b>[0.0.0.0] 0 0 0 0</b></li> </ul> <p>Using the embedded webserver or the DTM-based software:</p> <ul style="list-style-type: none"> <li>Set FDR synchronization to manual mode.</li> <li>Before the first connection, select local drive configuration. The drive needs first to push the configuration to the server.</li> </ul> <p>Enter the device name, <b>DEVICE NAME</b>, in the <b>[Communication] C o n -</b>, <b>[Comm parameters] C n P -</b> menu, <b>[Eth Module Config] E t o -</b> submenu.</p> |
| 2    | Turn off the drive                                | Turn off the drive and then back on again (control voltage if a separate power supply is being used), otherwise the device name is not taken into account                                                                                                                                                                                                                                                                                                                                                                                                                                                                                                                                                                                                                        |
| 3    | Connect the drive to the fieldbus                 | Connect the drive and the FDR server (PLC) to the Ethernet fieldbus.                                                                                                                                                                                                                                                                                                                                                                                                                                                                                                                                                                                                                                                                                                             |
| 4    | Configure the FDR server (see the PLC manual)     | The server downloads the IP addresses to the Ethernet adapter. Check that the operation has proceeded correctly: you can also check, in the <b>[Communication] C o n -</b> , <b>[Comm parameters] C n P -</b> menu, <b>[Eth Module Config] E t o -</b> submenu. Whether the <b>[Eth Option IP] , C 1 1 , C 1 2 , C 1 3 , C 1 4</b> , <b>[ETH Option Subnet Msk] , n 1 1 , n 1 2 , n 1 3 , n 1 4</b> and <b>[ETH Option Gate Add] , G 1 1 , G 1 2 , G 1 3 , G 1 4</b> parameters have values other than <b>[0.0.0.0] 0 0 0 0</b>                                                                                                                                                                                                                                                  |
| 5    | Supply the FDR server with the configuration file | Using the embedded webserver or the DTM-based software <ul style="list-style-type: none"> <li>Specify that the drive configuration is downloaded from the FDR server on each power-up</li> <li>Send a save command to the FDR server.</li> </ul>                                                                                                                                                                                                                                                                                                                                                                                                                                                                                                                                 |
| 6    | Check that the system is operational              | If the save operation has not been successful, the adapter detects a communication error which, in factory settings mode, triggers a <b>[FDR2 Error] F d r 2</b>                                                                                                                                                                                                                                                                                                                                                                                                                                                                                                                                                                                                                 |

## Replacing a Drive

For replacing a drive, it is necessary to follow the procedure below:

| Step | Action                              | Action                                                                                                                                                                                                                                                                                                                                                                                                                                                                                                                                                                                                                                                                                                                                                                                        |
|------|-------------------------------------|-----------------------------------------------------------------------------------------------------------------------------------------------------------------------------------------------------------------------------------------------------------------------------------------------------------------------------------------------------------------------------------------------------------------------------------------------------------------------------------------------------------------------------------------------------------------------------------------------------------------------------------------------------------------------------------------------------------------------------------------------------------------------------------------------|
| 1    | Configure the drive                 | <p>In the <b>[Communication] C o n -</b>, <b>[Comm parameters] C n P -</b> menu, <b>[Eth Module Config] E t o -</b> submenu:</p> <ul style="list-style-type: none"> <li>• Leave the IP address <b>[Eth Option IP] , C 1 1 , C 1 2 , C 1 3 , C 1 4</b> at the value <b>[0.0.0.0] 0 0 0 0</b></li> </ul> <p>Using the embedded webserver or the DTM-based software:</p> <ul style="list-style-type: none"> <li>• Set FDR synchronization to manual mode.</li> <li>• Before the first connection, select served drive configuration. The drive needs first to transfer the configuration from the server.</li> </ul> <p>Enter the device name, <b>DEVICE NAME</b>, in the <b>[Communication] C o n -</b>, <b>[Comm parameters] C n P -</b> menu, <b>[Eth Module Config] E t o -</b> submenu.</p> |
| 2    | Turn off the drive                  | Turn off the drive and then back on again (control voltage if a separate power supply is being used), otherwise the device name is not taken into account                                                                                                                                                                                                                                                                                                                                                                                                                                                                                                                                                                                                                                     |
| 3    | Connect the drive to the fieldbus   | Connect the drive and the FDR server (PLC) to the Ethernet fieldbus                                                                                                                                                                                                                                                                                                                                                                                                                                                                                                                                                                                                                                                                                                                           |
| 4    | Check that the drive is operational | <p>Check that the operation has proceeded correctly.</p> <p>If downloading has not been possible after a period of 2 min following assignment of the IP addresses, the adapter detects a communication error which, in factory settings mode, triggers an <b>[FDR2 Error] F d r 2</b></p>                                                                                                                                                                                                                                                                                                                                                                                                                                                                                                     |

## Section 4.4

### Communication Profile

#### What Is in This Section?

This section contains the following topics:

| Topic                                                  | Page |
|--------------------------------------------------------|------|
| Definition of a Profile                                | 109  |
| Functional Profiles Supported by the Drive             | 110  |
| Functional Description                                 | 111  |
| CIA402 Operating State Diagram                         | 112  |
| Description of Operating States                        | 113  |
| Summary                                                | 115  |
| Cmd Register <i>C P d</i>                              | 116  |
| Stop Commands                                          | 117  |
| Assigning Control Word Bits                            | 118  |
| [CIA402 State Reg] <i>E L R</i>                        | 119  |
| Starting Sequence                                      | 120  |
| Sequence for a Drive Powered by the Power Stage Supply | 121  |
| Sequence for a Drive with Separate Control Stage       | 122  |
| Sequence for a Drive with Mains Contactor Control      | 124  |

## Definition of a Profile

### Types of Profiles

There are 3 types of profile:

- Communication profiles
- Functional profiles
- Application profiles

### Communication Profile

A communication profile describes the characteristics of a bus or network:

- Cables
- Connectors
- Electrical characteristics
- Access protocol
- Addressing system
- Periodic exchange service
- Messaging service
- ...

A communication profile is unique to a type of fieldbus (such as Modbus, PROFIBUS DP, and so on) and is used by different types of devices.

### Functional Profile

A functional profile describes the behavior of a type of device:

- Functions
- Parameters (such as name, format, unit, type, and so on.)
- Periodic I/O variables
- State chart
- ...

A functional profile is common to all members of a device family (such as variable speed drives, encoders, I/O modules, displays, and so on).

They can feature common or similar parts. The standardized (IEC 61800-7) functional profiles of variable speed drives are:

- CiA402
- PROFIDRIVE
- CIP AC Drive

CiA402 device profile for drives and motion control represents the next stage of this standard development and is now part of the IEC 61800-7 standard.

### Application Profile

Application profile defines the services to be provided by the devices on a machine. For example, CiA DSP 417-2 V 1.01 part 2: CANopen application profile for lift control systems - virtual device definitions.

### Interchangeability

The aim of communication and functional profiles is to achieve interchangeability of the devices connected via the fieldbus.

## Functional Profiles Supported by the Drive

### I/O Profile

Using the I/O profile simplifies PLC programming.

The I/O profile mirrors the use of the terminal strip for control by utilizing 1 bit to control a function.

The I/O profile for the drive can also be used when controlling via a fieldbus. The drive starts up as soon as the `run` command is sent. 15 bits of the control word (bits 1...15) can be assigned to a specific function.

This profile can be developed for simultaneous control of the drive via:

- The terminals
- The Modbus control word
- The CANopen control word
- Ethernet Modbus TCP embedded
- The fieldbus module control word

The I/O profile is supported by the drive itself and therefore in turn by all the communication ports (integrated Modbus, and fieldbus modules).

### CiA402 Profile

The drive only starts up following a command sequence.

The control word is standardized.

5 bits of the control word (bits 11...15) can be assigned to a function.

The CiA402 profile is supported by the drive itself and therefore by all the communication ports (integrated Modbus, CANopen, and fieldbus modules).

The drive supports the `velocity` mode of CiA402 profile.

In the CiA402 profile, there are two modes that are specific to the drive and characterize commands and references value management:

- Separate **[Separate] S E P**
- Not separate **[Not separ.] S , П,**

## Functional Description

### Introduction

Drive operation involves two main functions, which are illustrated in the diagrams below.

### CiA402

The main parameters are shown with their CiA402 name and their CiA402/Drivecom index (the values in brackets are the CANopen addresses of the parameter).

The following figure shows the control diagram for drive operation:

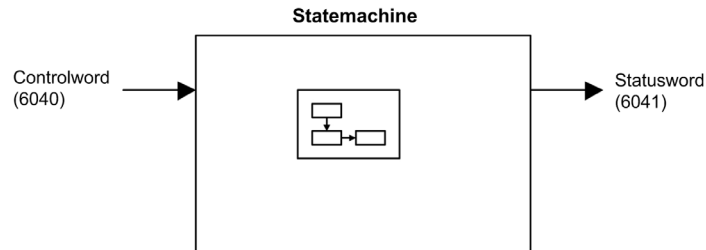

Simplified diagram for speed control in Velocity mode:

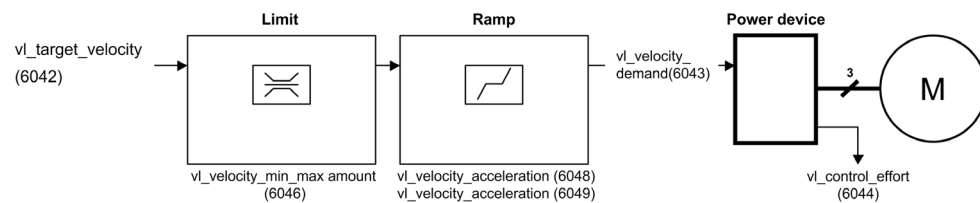

### Altivar Drive

These diagrams translate as follows for the Altivar drive.

The following figure shows the control diagram for drive operation:

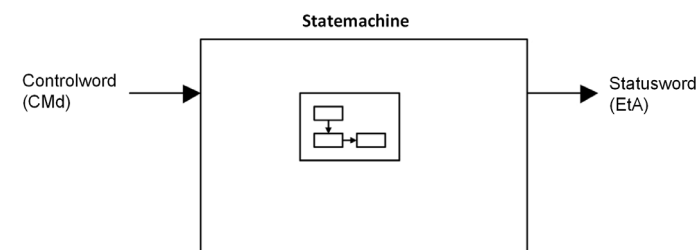

Simplified diagram for speed control in Velocity mode:

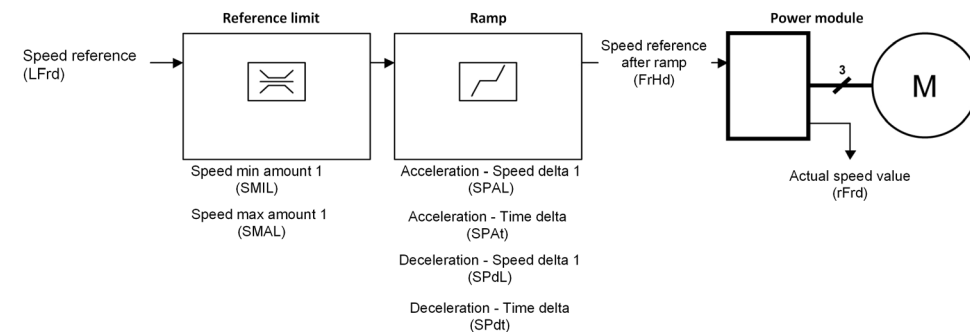

## CIA402 Operating State Diagram

### State Diagram

After switching on and when an operating mode is started, the product goes through a number of operating states.

The state diagram (state machine) shows the relationships between the operating states and the state transitions. The operating states are internally monitored and influenced by monitoring functions.

The following figure shows the CIA402 state diagram:

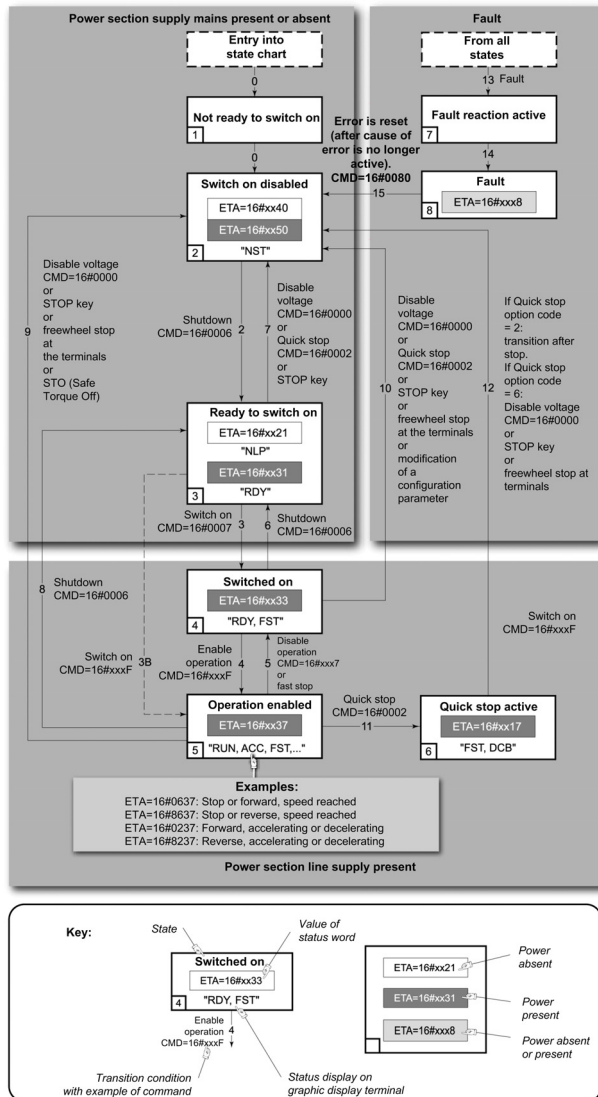

## Description of Operating States

### Drive Operating State

The operating state of the drive changes depending on whether the control word **[Cmd Register] *C n d***, is sent or an event occurs (an error detection, for example).

The drive operating state can be identified by the value of the status word **[CIA402 State Reg] *E E R***.

| Operating State            | Description                                                                                                                                                                                                                                                                                                                                                                                                                                                                                                                                                                                                                                                                                                                                                                                                                                                                                                                                                                                                                                                                                                                                                                                                                                                                                                                                                                                                                                                                                                                     |
|----------------------------|---------------------------------------------------------------------------------------------------------------------------------------------------------------------------------------------------------------------------------------------------------------------------------------------------------------------------------------------------------------------------------------------------------------------------------------------------------------------------------------------------------------------------------------------------------------------------------------------------------------------------------------------------------------------------------------------------------------------------------------------------------------------------------------------------------------------------------------------------------------------------------------------------------------------------------------------------------------------------------------------------------------------------------------------------------------------------------------------------------------------------------------------------------------------------------------------------------------------------------------------------------------------------------------------------------------------------------------------------------------------------------------------------------------------------------------------------------------------------------------------------------------------------------|
| 1 - Not ready to switch on | Initialization starts. This is a transient state invisible to the communication network.                                                                                                                                                                                                                                                                                                                                                                                                                                                                                                                                                                                                                                                                                                                                                                                                                                                                                                                                                                                                                                                                                                                                                                                                                                                                                                                                                                                                                                        |
| 2 - Switch on disabled     | The power stage is not ready to switch on.<br>The drive is locked, no power is supplied to the motor.<br>For a separate control stage, it is not necessary to supply the power.<br>For a separate control stage with mains contactor, the contactor is not closed.<br>The configuration and adjustment parameters can be modified.                                                                                                                                                                                                                                                                                                                                                                                                                                                                                                                                                                                                                                                                                                                                                                                                                                                                                                                                                                                                                                                                                                                                                                                              |
| 3 - Ready to switch on     | The power stage is ready to switch on and awaiting power stage supply mains.<br>For a separate control stage, it is not necessary to supply the power stage, but the system expects it in order to change to state 4 - Switched on.<br>For a separate control stage with mains contactor, the contactor is not closed.<br>The drive is locked, no power is supplied to the motor.<br>The configuration and adjustment parameters can be modified.                                                                                                                                                                                                                                                                                                                                                                                                                                                                                                                                                                                                                                                                                                                                                                                                                                                                                                                                                                                                                                                                               |
| 4 - Switched on            | Power stage is switched on.<br>For a separate control stage, the power stage must be supplied.<br>For a separate control stage with mains contactor, the contactor is closed.<br>The drive is locked, no power is supplied to the motor.<br>The power stage of the drive is ready to operate, but voltage has not yet been applied to the output.<br>The adjustment parameters can be modified.<br>If a configuration parameter is modified, the drive returns to the state 2 - Switch on disabled.                                                                                                                                                                                                                                                                                                                                                                                                                                                                                                                                                                                                                                                                                                                                                                                                                                                                                                                                                                                                                             |
| 5 - Operation enabled      | Power stage is enabled. The drive is in running state<br>For a separate control stage, the power stage must be supplied.<br>For a separate control stage with mains contactor, the contactor is closed.<br>The drive is unlocked, power is supplied to the motor.<br>The drive functions are activated and voltage is applied to the motor terminals.<br>If the reference value is zero or the <b>Halt</b> command is applied, no power is supplied to the motor and no torque is applied. To perform <b>[Auto tuning] <i>t u n</i></b> , the drive must be in state 5 - Operation enabled.<br>The adjustment parameters can be modified.<br>The configuration parameters cannot be modified.<br><br><b>NOTE:</b> The command 4 - Enable operation must be taken into consideration only if the channel is valid. In particular, if the channel is involved in the command and the reference value, transition 4 is possible only after the reference value has been received once.<br><br>The reaction of the drive to a <b>Disable operation</b> command depends on the value of the <b>[SwitchOnDisable Stp] <i>d o t d</i></b> parameter: <ul style="list-style-type: none"> <li>• If the <b>[SwitchOnDisable Stp] <i>d o t d</i></b> parameter is set to 0, the drive changes to operating state 4 - Switched on and stops in freewheel stop.</li> <li>• If the <b>[SwitchOnDisable Stp] <i>d o t d</i></b> parameter is set to 1, the drive stops on ramp and then changes to operating state 4 - Switched on.</li> </ul> |

| Operating State           | Description                                                                                                                                                                                                                                                                                                                                                                                                                                                                                                                                                                                                                                                                                                                                                                                                                                                                                                                                                                                                                        |
|---------------------------|------------------------------------------------------------------------------------------------------------------------------------------------------------------------------------------------------------------------------------------------------------------------------------------------------------------------------------------------------------------------------------------------------------------------------------------------------------------------------------------------------------------------------------------------------------------------------------------------------------------------------------------------------------------------------------------------------------------------------------------------------------------------------------------------------------------------------------------------------------------------------------------------------------------------------------------------------------------------------------------------------------------------------------|
| 6 - Quick stop active     | <p>The drive performs a fast stop and remains locked in the operating state 6-Quick stop active. Before restarting the motor, it is required to go to the operating state 2-switch on disabled.</p> <p>During fast stop, the drive is unlocked and power is supplied to the motor. The configuration parameters cannot be modified.</p> <p>The condition for transition 12 to state 2 - Switch on disabled depends on the value of the parameter Quick stop mode (QStd):</p> <p>If the Quick stop mode parameter has the value FST2, the drive stops according to the fast stop ramp and then changes to state 2 - Switch on disabled.</p> <p>If the Quick stop mode parameter has the value FST6, the drive stops according to the fast stop ramp and then remains in state 6 - Quick stop active until:</p> <ul style="list-style-type: none"> <li>● A Disable voltage command is received or</li> <li>● The <b>STOP</b> key is pressed or</li> <li>● A freewheel stop command via the digital input of the terminal.</li> </ul> |
| 7 - Fault reaction active | <p>Transient state during which the drive performs an action corresponding to the selected error response.</p>                                                                                                                                                                                                                                                                                                                                                                                                                                                                                                                                                                                                                                                                                                                                                                                                                                                                                                                     |
| 8 - Fault                 | <p>Error response terminated. Power stage is disabled.</p> <p>The drive is locked, no power is supplied to the motor.</p>                                                                                                                                                                                                                                                                                                                                                                                                                                                                                                                                                                                                                                                                                                                                                                                                                                                                                                          |

## Summary

### Device Status Summary

| Operating State            | Power Stage Supply for Separate Control Stage | Power Supplied to Motor                 | Modification of Configuration Parameters              |
|----------------------------|-----------------------------------------------|-----------------------------------------|-------------------------------------------------------|
| 1 - Not ready to switch on | Not required                                  | No                                      | Yes                                                   |
| 2 - Switch on disabled     | Not required                                  | No                                      | Yes                                                   |
| 3 - Ready to switch on     | Not required                                  | No                                      | Yes                                                   |
| 4 - Switched on            | Required                                      | No                                      | Yes, return to 2 - Switch on disabled operating state |
| 5 - Operation enabled      | Required                                      | Yes                                     | No                                                    |
| 6 - Quick stop active      | Required                                      | Yes, during fast stop                   | No                                                    |
| 7 - Fault reaction active  | Depends on error response configuration       | Depends on error response configuration | -                                                     |
| 8 - Fault                  | Not required                                  | No                                      | Yes                                                   |

## Cmd Register [ 7 ]

### Bit Mapping of the Control Word

| Bit 7                                                                         | Bit 6         | Bit 5         | Bit 4         | Bit 3            | Bit 2                 | Bit 1                            | Bit 0                   |
|-------------------------------------------------------------------------------|---------------|---------------|---------------|------------------|-----------------------|----------------------------------|-------------------------|
| Fault reset                                                                   | Reserved (=0) | Reserved (=0) | Reserved (=0) | Enable operation | Quick stop            | Enable voltage                   | Switch on               |
| 0 to 1 transition = Error is reset (after cause of error is no longer active) |               |               |               | 1 = Run command  | 0 = Quick stop active | Authorization to supply AC power | Mains contactor control |

| Bit 15                           | Bit 14                           | Bit 13                           | Bit 12                           | Bit 11                                                     | Bit 10        | Bit 9         | Bit 8 |
|----------------------------------|----------------------------------|----------------------------------|----------------------------------|------------------------------------------------------------|---------------|---------------|-------|
| Manufacturer specific assignable | Manufacturer specific assignable | Manufacturer specific assignable | Manufacturer specific assignable | Manufacturer specific                                      | Reserved (=0) | Reserved (=0) | Halt  |
|                                  |                                  |                                  |                                  | 0 = Forward direction asked<br>1 = Reverse direction asked |               |               | Halt  |

| Command           | State Transition | Final Operating State  | Bit 7       | Bit 3            | Bit 2      | Bit 1          | Bit 0     | Example Value |
|-------------------|------------------|------------------------|-------------|------------------|------------|----------------|-----------|---------------|
|                   |                  |                        | Fault Reset | Enable Operation | Quick Stop | Enable Voltage | Switch On |               |
| Shutdown          | 2, 6, 8          | 3 - Ready to switch on | X           | X                | 1          | 1              | 0         | 0006 hex      |
| Switch on         | 3                | 4 - Switched on        | X           | X                | 1          | 1              | 1         | 0007 hex      |
| Enable operation  | 4                | 5 - Operation enabled  | X           | 1                | 1          | 1              | 1         | 000F hex      |
| Disable operation | 5                | 4 - Switched on        | X           | 0                | 1          | 1              | 1         | 0007 hex      |
| Disable voltage   | 7, 9, 10, 12     | 2 - Switch on disabled | X           | X                | X          | 0              | X         | 0000 hex      |
| Quick stop        | 11               | 6 - Quick stop active  | X           | X                | 0          | 1              | X         | 0002 hex      |
|                   | 7, 10            | 2 - Switch on disabled |             |                  |            |                |           |               |
| Fault reset       | 15               | 2 - Switch on disabled | 0 → 1       | X                | X          | X              | X         | 0080 hex      |

X: Value is of no significance for this command.  
0 → 1: Command on rising edge.

## Stop Commands

### Halt Command

The `Halt` command enables movement to be interrupted without having to leave the `5 - Operation enabled state`. The stop is performed in accordance with the `[Type of stop] 5 L L` parameter.

If the `Halt` command is active, no power is supplied to the motor and no torque is applied.

Regardless of the assignment of the `[Type of stop] 5 L L` parameter `[Fast stop Assign] F 5 L`, `[Ramp stop] r P P`, `[Freewheel Stop] n 5 L`, or `[DC Injection Assign] d L i`, the drive remains in the `5 - Operation enabled state`.

### Fast Stop Command

A `Fast Stop` command at the terminals or using a bit of the control word assigned to `Fast Stop` causes a change to the `4 - Switched on`

### Freewheel Command

A `Freewheel Stop` command using a digital input of the terminal or a bit of the control word assigned to `Freewheel Stop` causes a change to operating state `2 - Switch on disabled`.

## Assigning Control Word Bits

### Function Codes

In the CiA402 profile, fixed assignment of a function input is possible using the following codes:

| Bit    | Ethernet Module |
|--------|-----------------|
| Bit 11 | C311            |
| Bit 12 | C312            |
| Bit 13 | C313            |
| Bit 14 | C314            |
| Bit 15 | C315            |

For example, to assign the DC injection braking to bit13 of the fieldbus module, simply configure the **[DC Injection Assign]** `dcI` parameter with the **[C313]** `C313` value.

Bit 11 is assigned by default to the operating direction command **[Reverse Assign]** `rr5`.

## [CIA402 State Reg] E L F

## Bit Mapping of the Status Word

| Bit 7               | Bit 6                       | Bit 5                    | Bit 4                      | Bit 3          | Bit 2             | Bit 1       | Bit 0                           |
|---------------------|-----------------------------|--------------------------|----------------------------|----------------|-------------------|-------------|---------------------------------|
| Warning             | Switch on disabled          | Quick stop               | Voltage enabled            | Fault          | Operation enabled | Switched on | Ready to switch on              |
| A warning is active | Power stage supply disabled | 0 = Quick stop is active | Power stage supply present | Error detected | Running           | Ready       | 1 = Awaiting power Stage supply |

| Bit 15                                      | Bit 14                                  | Bit 13        | Bit 12        | Bit 11                         | Bit 10                  | Bit 9                                   | Bit 8         |
|---------------------------------------------|-----------------------------------------|---------------|---------------|--------------------------------|-------------------------|-----------------------------------------|---------------|
| Manufacturer-specific Direction of rotation | Manufacturer-specific Stop via STOP key | Reserved (=0) | Reserved (=0) | Internal limit active          | Target reached          | Remote                                  | Reserved (=0) |
|                                             |                                         |               |               | Reference value outside limits | Reference value reached | Command or reference value via fieldbus |               |

| Operating State           | Bit 6              | Bit 5      | Bit 4           | Bit 3 | Bit 2             | Bit 1       | Bit 0              | ETA Masked by 006F H <sup>(1)</sup>     |
|---------------------------|--------------------|------------|-----------------|-------|-------------------|-------------|--------------------|-----------------------------------------|
|                           | Switch On Disabled | Quick Stop | Voltage Enabled | Fault | Operation Enabled | Switched On | Ready to Switch On |                                         |
| 1 -Not ready to switch on | 0                  | X          | X               | 0     | 0                 | 0           | 0                  | -                                       |
| 2 -Switch on disabled     | 1                  | X          | X               | 0     | 0                 | 0           | 0                  | 0040 hex                                |
| 3 -Ready to switch on     | 0                  | 1          | X               | 0     | 0                 | 0           | 1                  | 0021 hex                                |
| 4 - Switched on           | 0                  | 1          | 1               | 0     | 0                 | 1           | 1                  | 0023 hex                                |
| 5 - Operation enabled     | 0                  | 1          | 11              | 0     | 1                 | 1           | 1                  | 0027 hex                                |
| 6 -Quick stop active      | 0                  | 0          |                 | 0     | 1                 | 1           | 1                  | 0007 hex                                |
| 7 -Fault reaction active  | 0                  | X          | X               | 1     | 1                 | 1           | 1                  | -                                       |
| 8 -Fault                  | 0                  | X          | X               | 1     | 0                 | 0           | 0                  | 0008 hex <sup>(2)</sup> ..<br>.0028 hex |

(1) This mask can be used by the PLC program to test the diagram state.  
(2) detected error following operating state 6 - Quick stop active.  
X: In this state, the value of the bit can be 0 or 1.

## Starting Sequence

### Description

The command sequence in the state diagram depends on how power is being supplied to the drive.

There are 3 possible scenarios:

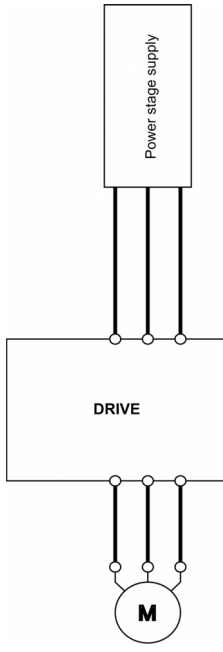
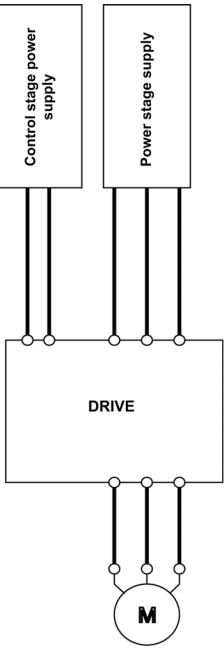
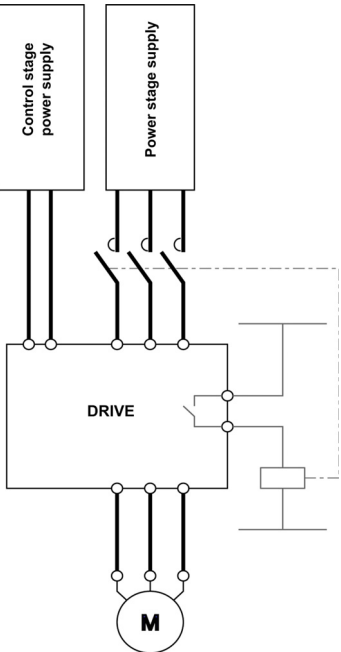
|                                                            |                                                                                    |                                                                                     |                                                                                      |
|------------------------------------------------------------|------------------------------------------------------------------------------------|-------------------------------------------------------------------------------------|--------------------------------------------------------------------------------------|
|                                                            |  |  |  |
| <b>Power stage supply</b>                                  | Direct                                                                             | Direct                                                                              | Mains contactor controlled by the drive                                              |
| <b>Control stage supply</b>                                | Not separate <sup>(1)</sup>                                                        | Separate                                                                            | Separate                                                                             |
| <sup>(1)</sup> The power stage supplies the control stage. |                                                                                    |                                                                                     |                                                                                      |

## Sequence for a Drive Powered by the Power Stage Supply

### Description

Both the power and control stages are powered by the power stage supply.  
If power is supplied to the control stage, it has to be supplied to the power stage as well.  
The following sequence must be applied:

### Step 1

Apply the 2 - Shut down command

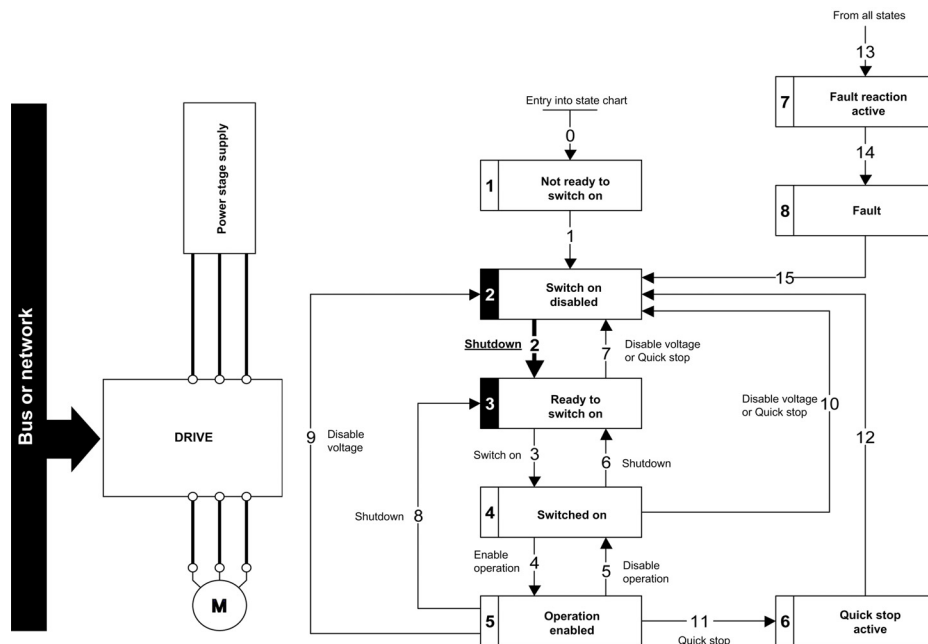

### Step 2

- Check that the drive is in the operating state 3 - Ready to switch on.
- Then apply the 4 - Enable operation command.
- The motor can be controlled (send a reference value not equal to zero).

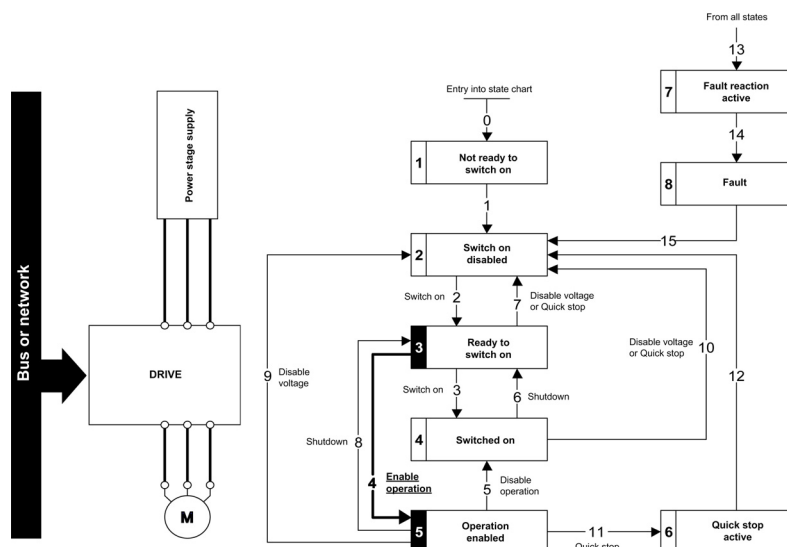

**NOTE:** It is possible, but not necessary to apply the 3 - Switch on command followed by the 4 - Enable Operation command to switch successively into the operating states 3 - Ready to Switch on, 4 - Switched on and then 5 - Operation Enabled. The 4 - Enable operation command is sufficient.

## Sequence for a Drive with Separate Control Stage

### Description

Power is supplied separately to the power and control stages.

If power is supplied to the control stage, it does not have to be supplied to the power stage as well.

The following sequence must be applied:

### Step 1

- The power stage supply is not necessarily present.
- Apply the 2 - Shut down command

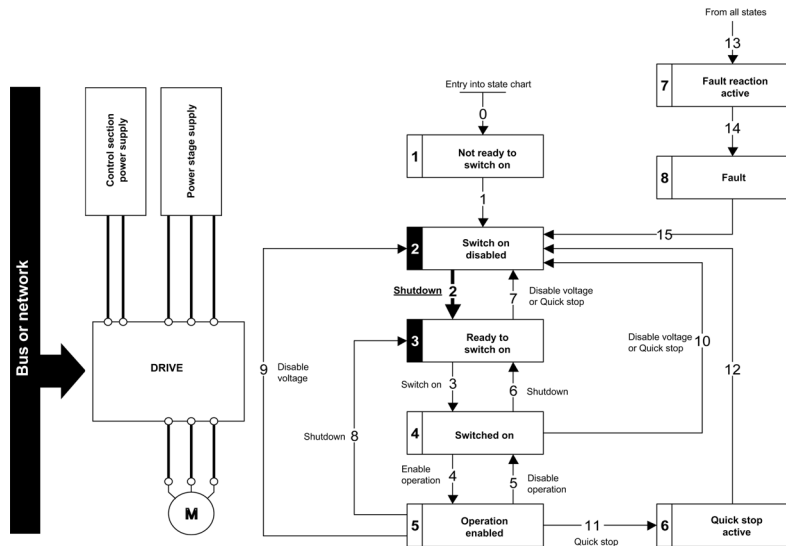

### Step 2

- Check that the drive is in the operating state 3 - Ready to switch on.
- Check that the power stage supply is present (Voltage enabled of the status word).

| Power Stage Supply | Terminal Display | Status Word |
|--------------------|------------------|-------------|
| Absent             | <i>n L P</i>     | 21 hex      |
| Present            | <i>r d Y</i>     | 31 hex      |

- Apply the 3 - Switch on command

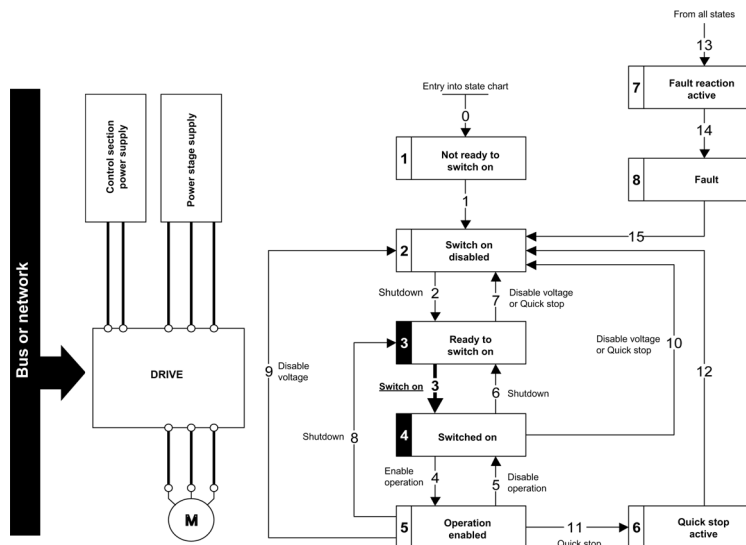

## Step 3

- Check that the drive is in the operating state 4 - Switched on.
- Then apply the 4 - Enable operation command.
- The motor can be controlled (send a reference value not equal to zero).
- If the power stage supply is still not present in the operating state 4 - Switched on after a time delay [Mains V. time out] L C E, the drive triggers an error [Input Contactor] L C F.

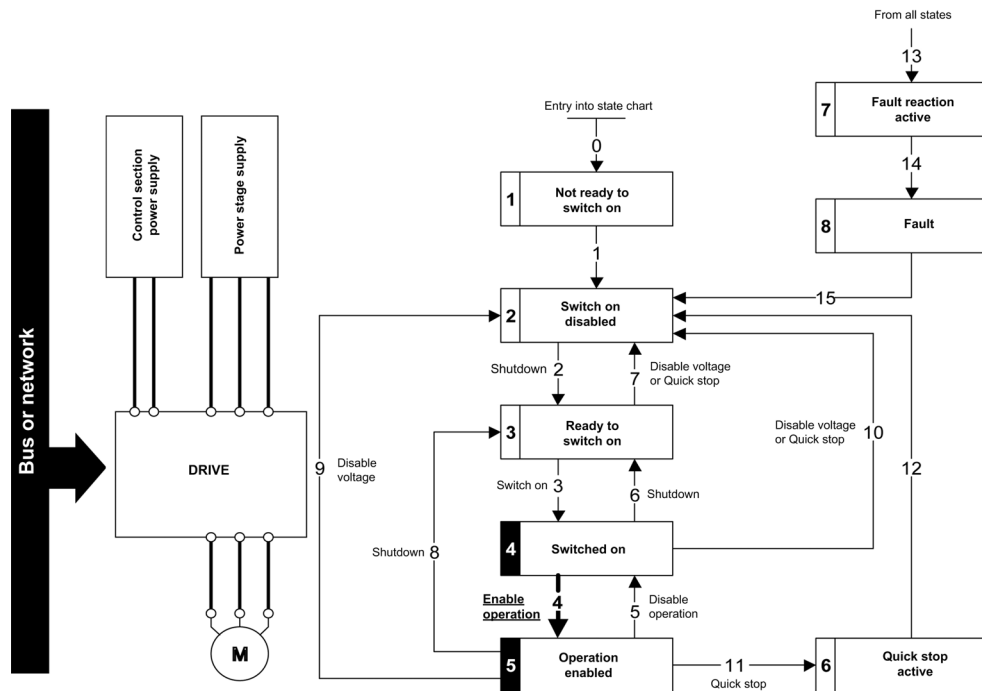

## Sequence for a Drive with Mains Contactor Control

### Description

Power is supplied separately to the power and control stages.

If power is supplied to the control stage, it does not have to be supplied to the power stage as well. The drive controls the mains contactor.

The following sequence must be applied:

### Step 1

- The power stage supply is not present as the mains contactor is not being controlled.
- Apply the 2 - Shutdown command.

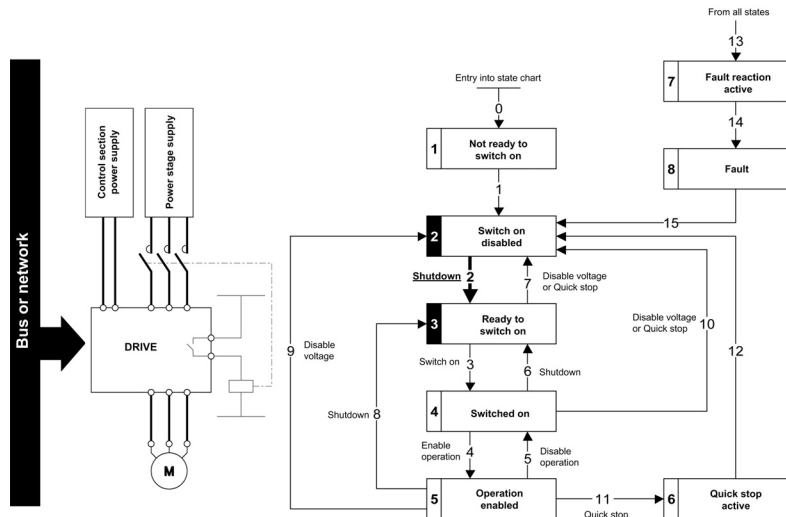

### Step 2

- Check that the drive is in the operating state 3 - Ready to switch on.
- Apply the 3 - Switch on command, which closes the mains contactor and switch on the power stage supply.

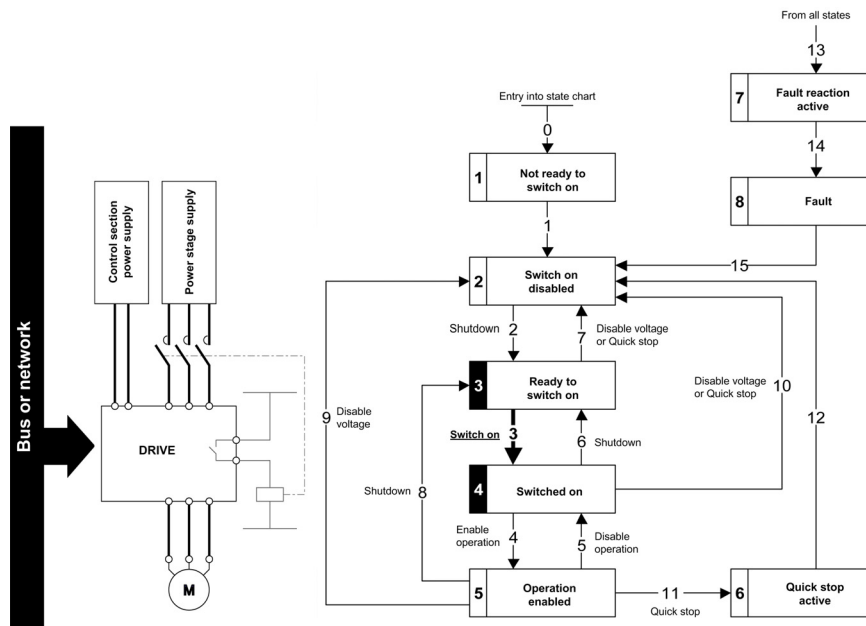

---

## Section 4.5

### Embedded Webserver

---

#### What Is in This Section?

This section contains the following topics:

| Topic                       | Page |
|-----------------------------|------|
| Overview                    | 126  |
| Connection to the Webserver | 127  |
| My Dashboard                | 129  |
| Display - Drive             | 130  |
| Setup - My Preference       | 131  |

## Overview

### Webserver

The Ethernet adapter provides an integrated Web server (in six languages) which allows several functions like: display, parameter settings, and diagnostics. This chapter describes the services provided by this webservice.

The webservice can be accessed from standard browsers like Internet Explorer, chrome, safari, or Firefox.

## Connection to the Webserver

### Access

The webserver can be accessed from standard browsers.

In the following example, the drive has received the IP address 10.0.0.5:



First connect the computer to the drive by typing `http://` followed by the drive IP address.

You are asked to first enter a **User Name** and a **Password**.

By default the user name is ADMIN. If you are connecting to the webserver for the first time, the password is available from the Graphic Display Terminal of the drive in the **[Main Menu] / [My preference] ПУР/[Webserver] W B S - /[Webserver default password] W d P** menu. Once logged in you are asked to change the default connection ID (User Name and Password), according to the default security access rule. Access rules can be modified in the Setup/Access Management web page.

Once connected, the webserver home page is displayed.

Using IPV6 network discovery service, there is no need to set IP parameters. The drive appears automatically in the network explorer of the PC while physically connected.

The drive is identified as `ATV6.....-MMMM` where `MMMM` is the two last bytes of the MAC address.

Right-click and select **Display device web page** to open the webserver.

### User Rights - Password and User Names

A new password is required if you are connecting to the webserver for the first time. Default security access rule requires minimum eight characters for the new password.

The user names and the password of both level can be modified from the administration section.

## Web Server Site Map

The descriptions of the Web server pages are shown in the following table

| Page                | Menu                | Description                                                                                                       |
|---------------------|---------------------|-------------------------------------------------------------------------------------------------------------------|
| <b>My Dashboard</b> |                     | This page can be customized, adding or removing Widgets that are designed for a quick overview of the drive data. |
| <b>Display</b>      | Drive               | Drive parameters are displayed in data tables. Customized tables can be created.                                  |
|                     | Energy Dashboard    | Trends show information about the energy consumption of the drive.                                                |
|                     | Chart Viewer        | Drive parameters are displayed in charts. Customized charts can be created.                                       |
| <b>Diagnostics</b>  | Drive               | Drive diagnostics are displayed.                                                                                  |
|                     | Fieldbus            | Communication diagnostics are displayed.                                                                          |
| <b>Drive</b>        | Drive Parameter     | Drives settings can be modified.                                                                                  |
|                     | Drive Communication | Communication settings can be modified.                                                                           |
| <b>Setup</b>        | Fieldbus            | Drive Ethernet settings can be modified.                                                                          |
|                     | File Transfer       | Drive configuration and reports can be downloaded or loaded between a computer and the drive.                     |
|                     | My Preferences      | Webserver access and appearance can be handled.                                                                   |







## My Dashboard

### Overview

The following table provides the procedure to add the widget to this page:

| Step | Action                                 |
|------|----------------------------------------|
| 1    | Click the <b>add a widget</b> button.  |
| 2    | Drag a widget to the desired location. |



The following figure shows the widgets that can be added. Various widgets of a same category are available.

|                                                                                       |
|---------------------------------------------------------------------------------------|
|  0   |
| Simply Start                                                                          |
|  0   |
| Drive ID                                                                              |
|  3   |
| Chart                                                                                 |
|  ∞   |
| Data Table                                                                            |
|  0   |
| Energy Manager                                                                        |
|  0 |
| Diagnostics                                                                           |
|  3 |
| Graphical View                                                                        |

## Display - Drive



### Data Table

The following table provides the procedure to create data tables of drive parameters.

| Step | Action                                                                                                                                                                                                                                                      |
|------|-------------------------------------------------------------------------------------------------------------------------------------------------------------------------------------------------------------------------------------------------------------|
| 1    | Type the name of the table. Spaces are not allowed in this field.                                                                                                                                                                                           |
| 2    | Select a parameter by clicking the top of the parameter or typing the code and clicking the  button. To delete a parameter while creating the table click the parameter. |
| 3    | Click the <b>Add Table</b> button. To remove a table click the  button, only visible when the table is selected.                                                         |

### Chart Viewer

The following table provides the procedure to create a chart viewer.



| Step | Action                                                                                                                                                                                                                                                                                                  |
|------|---------------------------------------------------------------------------------------------------------------------------------------------------------------------------------------------------------------------------------------------------------------------------------------------------------|
| 1    | Type the name of the chart. Spaces are not allowed in this field.                                                                                                                                                                                                                                       |
| 2    | Select the plot frequency.                                                                                                                                                                                                                                                                              |
| 3    | Select the plot frequency unit.                                                                                                                                                                                                                                                                         |
| 4    | Select the number of plot points.                                                                                                                                                                                                                                                                       |
| 5    | Select a parameter by clicking the top of the parameter or typing the code and clicking the  button. To delete a parameter while creating the chart click the parameter. Maximum of five parameters can be selected. |
| 6    | Click the <b>Create Chart</b> button, To remove a chart click the  button, only visible when chart is selected.                                                                                                     |

## Setup - My Preference

### User Access

In this menu, the access to the Web server can be managed by users with administrator rights. These users can add, remove, block, unblock, and modify the access rights of other users.



The following table shows the description of the buttons located in this menu:

| Button                                                                            | Description                                                                      |
|-----------------------------------------------------------------------------------|----------------------------------------------------------------------------------|
|  | Add a new user, typing the name of the user; the password and the access rights. |
|  | Block and unblock the access of a user to the webserver                          |
|  | Change the password. The administrator can change the password of other users.   |

### Themes

In this menu, the aspect of the Web server can be changed. Predefined themes are available, which can be customized.

The following table provides the procedure for creating new themes

| Step | Action                                                                                                                    |
|------|---------------------------------------------------------------------------------------------------------------------------|
| 1    | Click the  button.                       |
| 2    | Type the name of the theme. Spaces are not allowed in this field.                                                         |
| 3    | Type the description of the theme.                                                                                        |
| 4    | Upload a logo by clicking the  button. |
| 5    | Type name of the website.                                                                                                 |
| 6    | Click the <b>Save</b> button.                                                                                             |

### Access Management

Select if login credentials are required or not to access to the web server. The password policy can be changed.

The following table describes the different actions that can be set to enforce the password policy.

| Action                            | Description                                                                                                                               |
|-----------------------------------|-------------------------------------------------------------------------------------------------------------------------------------------|
| <b>Enforce Password Policy</b>    | Enable or disable the password enforcement                                                                                                |
| <b>Password History</b>           | Limits the number of failed attempts to access before locking the user account, it can be set to disable or three and even five attempts. |
| <b>Special Character Required</b> | If enabled, a special character is mandatory when creating a password for a user account.                                                 |
| <b>Numeric Character</b>          | If enabled, a numeric character is mandatory when creating a password for a user account.                                                 |
| <b>Alphabetic Character</b>       | If enabled, an alphabetical character is mandatory when creating a password for a user account.                                           |
| <b>Minimum Password Length</b>    | If enabled, a preset number of characters is mandatory when creating a password for a user account.                                       |

## Section 4.6

### Fieldbus Integration Using Unity Pro (M580)

---

#### What Is in This Section?

This section contains the following topics:

| Topic                       | Page |
|-----------------------------|------|
| Introduction                | 133  |
| EtherNet/IP Configuration   | 134  |
| Configuration of the Master | 135  |
| DTM Library                 | 136  |
| DTM Browser                 | 137  |

## Introduction

### Overview

The following figure shows the basic configuration to control the drive with a M580 PLC. The version of Unity used here is Unity Pro XL.



## EtherNet/IP Configuration

### Ethernet Port Configuration

From the project browser, open the Ethernet/IP port configuration by double-clicking the Ethernet port.

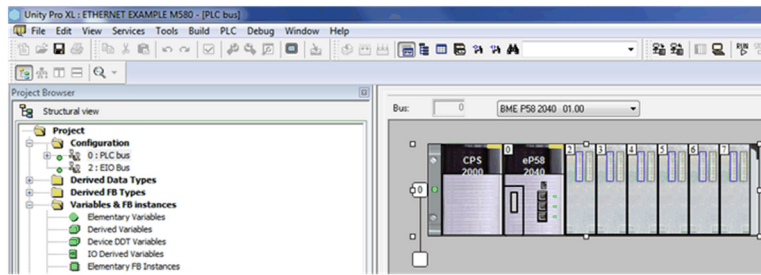

## Configuration of the Master

### PLC Configuration

The configuration of the memory area of the PLC is set by default and can be modified.

The screenshot shows the 'Configuration' tab of a software interface. It is divided into several sections:

- Operating mode:** Contains checkboxes for 'Run/Stop', 'Run/Stop by input only', 'Memory protect', 'Automatic start in Run' (checked), 'Initialize %MWi on cold start' (checked), and 'Cold Start Only'.
- Size of global address fields:** A table of values:
 

|     |     |      |       |      |     |
|-----|-----|------|-------|------|-----|
| %M: | 512 | %MW: | 1,024 | %KW: | 256 |
| %S: | 128 | %SW: | 168   |      |     |
- Buttons:** 'Default values' and 'Maximum values'.
- Configuration Online Modification:** A checkbox for 'Online modification in RUN or STOP'.

The IP address can be managed in the **IPConfig** tab.

The screenshot shows the 'IPConfig' tab of the software interface. It contains the following configuration fields:

- Main IP address:** 192 . 168 . 10 . 1
- IP address A:** 192 . 168 . 11 . 1
- IP address B:** 0 . 0 . 0 . 0 (Used for Hot Standby)
- Subnetwork mask:** 255 . 255 . 0 . 0
- Gateway address:** 192 . 168 . 10 . 1

## DTM Library

### Configuring the Drive Using Unity Pro

Before configuring the drive using Unity Pro, verify that the DTM and the drive firmware are compatible. The DTM libraries are available on [www.schneider-electric.com](http://www.schneider-electric.com).

## DTM Browser

### Launch the DTM Using Unity Pro

After installing the DTM library on your PC, restart the Unity Pro to add the DTM to the Unity Pro libraries. Open the DTM browser to add the drive to the configuration, as shown in the following figure:

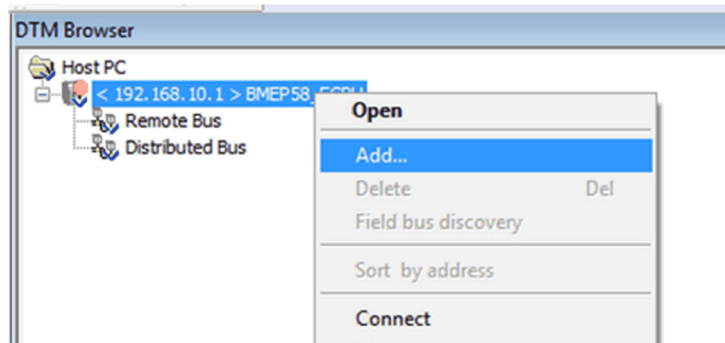

Select the drive from the list and click the **Add DTM** button to add the DTM.

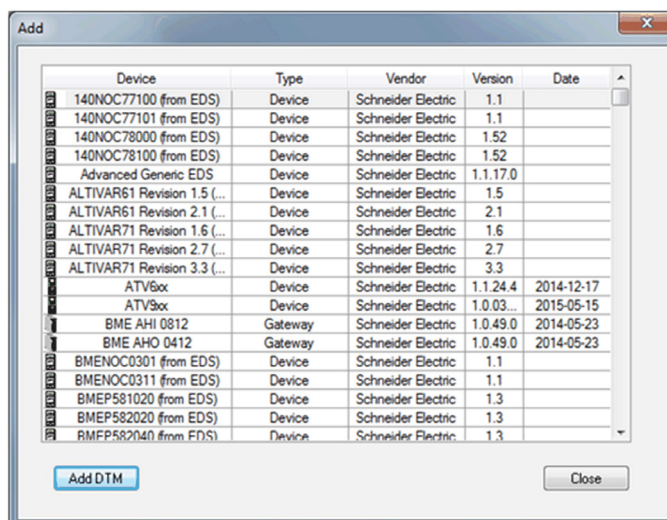

You can select even Modbus or EtherNet/IP communication with this configuration.

Finally the drive used in the configuration can be named with an alias in order to differentiate it in the case of using other drives. The alias name is used by default as device name for FDR service. The DTM online help is available in this window.

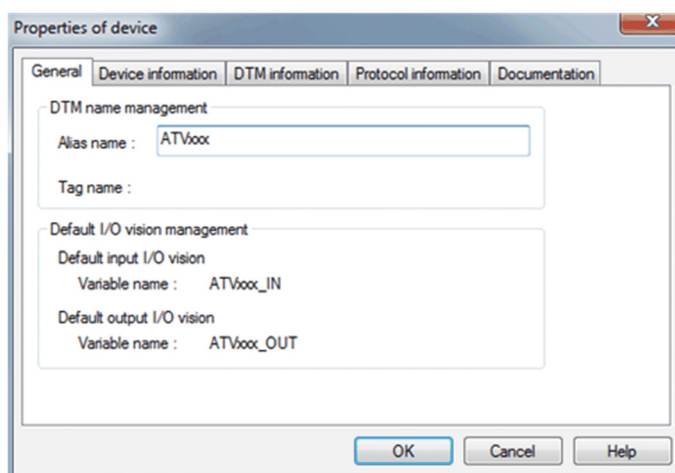



---

# Chapter 5

## Operations

---

### What Is in This Chapter?

This chapter contains the following sections:

| Section | Topic            | Page |
|---------|------------------|------|
| 5.1     | Operating States | 140  |
| 5.2     | Operating Modes  | 142  |

## Section 5.1 Operating States

### Configuring Communication Error Response

#### Description

The response of the drive in the event of Ethernet communication interruption can be configured. Configuration can be performed using the display terminal from the **[Complete settings] C 5 E -**, **[Error/Warning handling] C 5 W Π -** menu, **[Communication Module] C 0 Π 0 -** submenu, via the **[Fieldbus Interrupt Resp] C L L** parameter.

The values of the **[Fieldbus Interrupt Resp] C L L** parameter, which triggers a transition to the operating state fault **[Fieldbus Com Interrupt] C n F** are:

| Value                         | Meaning                          |
|-------------------------------|----------------------------------|
| <b>[Freewheel Stop] Y E 5</b> | Freewheel stop (factory setting) |
| <b>[Ramp stop] r Π P</b>      | Stop on ramp                     |
| <b>[Fast stop] F 5 E</b>      | Fast stop                        |
| <b>[DC injection] d C i</b>   | DC injection stop                |

The values of the **[Fieldbus Interrupt Resp] C L L** parameter, which does not trigger a transition to the operating state fault are:

| Value                           | Meaning                                                                                                                                                 |
|---------------------------------|---------------------------------------------------------------------------------------------------------------------------------------------------------|
| <b>[Ignore] n 0</b>             | Detected error ignored                                                                                                                                  |
| <b>[Per STT] 5 E E</b>          | Stop according to configuration of <b>[Type of stop] 5 E E</b>                                                                                          |
| <b>[Fallback Speed] L F F</b>   | Change to fallback speed, maintained as long as the detected error persists and the run command has not been removed                                    |
| <b>[Speed maintained] r L 5</b> | The drive maintains the speed at the time the detected error occurred, as long as the detected error persists, and the run command has not been removed |

The fallback speed can be configured in the **[Complete settings] C 5 E -**, **[Error/Warning handling] C 5 W Π -** menu, **[Fallback speed] L F F -** submenu, using the **[FallbackSpeed] L F F** parameter.

### **WARNING**

#### **LOSS OF CONTROL**

If this parameter is set to **n 0**, fieldbus communication monitoring is disabled.

- Only use this setting after a thorough risk assessment in compliance with all regulations and standards that apply to the device and to the application.
- Only use this setting for tests during commissioning.
- Verify that communication monitoring has been re-enabled before completing the commissioning procedure and performing the final commissioning test.

**Failure to follow these instructions can result in death, serious injury, or equipment damage.**

## Detected Errors

| Parameter                                                          | Description                                                                                                                                                                                                                             | Possible Values                                                                                                                                                                                                                                                                                                                                                                                                                                                                                                               | Terminal Display                                                                                                                                                                                                                                                                                                                                                                                                                                                                                                            |
|--------------------------------------------------------------------|-----------------------------------------------------------------------------------------------------------------------------------------------------------------------------------------------------------------------------------------|-------------------------------------------------------------------------------------------------------------------------------------------------------------------------------------------------------------------------------------------------------------------------------------------------------------------------------------------------------------------------------------------------------------------------------------------------------------------------------------------------------------------------------|-----------------------------------------------------------------------------------------------------------------------------------------------------------------------------------------------------------------------------------------------------------------------------------------------------------------------------------------------------------------------------------------------------------------------------------------------------------------------------------------------------------------------------|
| <b>[Fieldbus Com Interrupt] <i>C n F</i></b> Written to the device | This parameter is used to indicate that fieldbus error has been detected. When the detected error is active, the value corresponds to the cause of the error. When the cause of the error is no longer active, the value is reset to 0. | 1: Modbus TCP timeout<br>4: Ethernet IP timeout                                                                                                                                                                                                                                                                                                                                                                                                                                                                               | <b>[1] 1</b><br><b>[4] 4</b>                                                                                                                                                                                                                                                                                                                                                                                                                                                                                                |
| <b>[Fieldbus Error] <i>E P F 2</i></b>                             | -                                                                                                                                                                                                                                       | 1: Invalid IP address<br>2: Duplicate IP address                                                                                                                                                                                                                                                                                                                                                                                                                                                                              | <b>[1] 1</b><br><b>[2] 2</b>                                                                                                                                                                                                                                                                                                                                                                                                                                                                                                |
| <b>[FDR 2 Error] <i>F d r 2</i></b>                                | This parameter is used to indicate that an error has been detected during FDR procedure. Details about this error are provided using FDR1 parameter.                                                                                    | 0: No error<br>1: Server timeout<br>2: No file on server<br>3: Corrupted file on server<br>4: Empty file on server<br>5: Invalid file on drive<br>6: CRC error<br>7: Version incompatibility between drive and file.<br>9: No file on drive<br>10: File size reading error on server<br>11: Drive cannot open the file<br>12: Drive cannot read the file<br>13: File incompatibility<br>14: Drive name is invalid<br>15: Incorrect file size on server<br>16: Drive cannot write the file<br>17: Server cannot write the file | <b>[No error]</b><br><b>[Server Timeout]</b><br><b>[Server No File]</b><br><b>[Server Corrupt File]</b><br><b>[Server Empty File]</b><br><b>[Drive Invalid File]</b><br><b>[CRC Error]</b><br><b>[Version Incompatibility]</b><br><br><b>[Drive No File]</b><br><b>[Server Reading Size]</b><br><b>[Drive Opening File]</b><br><b>[Drive Reading File]</b><br><b>[Incompatibility]</b><br><b>[Drive Invalid Name]</b><br><b>[Server Incorrect File Size]</b><br><b>[Drive Writing File]</b><br><b>[Server Writing File]</b> |

---

## Section 5.2

### Operating Modes

---

#### What Is in This Section?

This section contains the following topics:

| Topic                                                                          | Page |
|--------------------------------------------------------------------------------|------|
| Configuring the Control Channel                                                | 143  |
| Configuration of the Drive for Operation in I/O Profile                        | 144  |
| Configuration of the Drive for Operation with CiA 402 Profile in Combined Mode | 145  |
| Configuration of the Drive for Operation with CiA 402 Profile in Separate Mode | 146  |

---

## Configuring the Control Channel

### Overview

This chapter explains how to configure the drive for operation from communication network through three following examples.

- I/O mode - a simple command word (based on forward, reverse, and reset binary commands).
- Combined mode (with native profile CiA 402) - Both reference value and command word come from the communication network.
- Separate (with native profile CiA 402) - reference value and command come from separate sources: for example, the command (in CiA 402) comes from the communication network and the reference value from the HMI.

## Configuration of the Drive for Operation in I/O Profile

### Description

For the I/O profile, here is a simple example, which can be extended with additional features. The command word is made of run forward (bit 0 of CMd), run reverse (bit 1 of CMd), and the function fault reset (bit 7 of CMd). The reference frequency is given by Graphic Display Terminal.

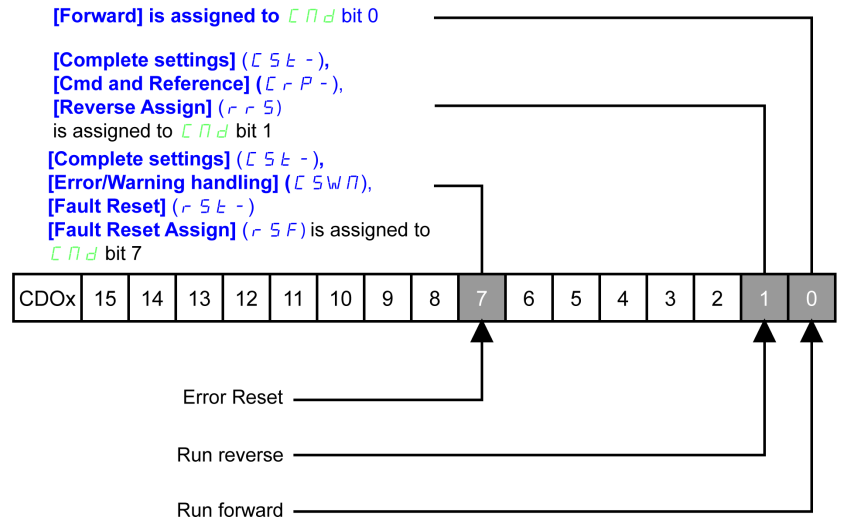

The settings are the following:

|                                |                            |
|--------------------------------|----------------------------|
| [Ref Freq 1 Config] <i>FR1</i> | [HMI] <i>HMI</i>           |
| [Control Mode] <i>CHCF</i>     | [I/O profile] <i>IO</i>    |
| [Command switching] <i>CCS</i> | [Cmd Channel 1] <i>CD1</i> |
| [Cmd channel 1] <i>CD1</i>     | [Com. Module] <i>NET</i>   |

The bits of the command word can now be configured.

In the [Command and Reference] *CRP-* menu configure:

|                            |                    |
|----------------------------|--------------------|
| [Reverse Assign] <i>RS</i> | [CD01] <i>CD01</i> |
|----------------------------|--------------------|

In the [Error/Warning handling] *SWN* - menu, [Fault reset] *RS-* submenu, configure:

|                                 |                    |
|---------------------------------|--------------------|
| [Fault Reset Assign] <i>RSF</i> | [CD07] <i>CD07</i> |
|---------------------------------|--------------------|

## Configuration of the Drive for Operation with CiA 402 Profile in Combined Mode

### Description

This section describes how to configure the settings of the drive if it is controlled in CiA 402 mode. The example focuses on the not separate mode. Additional modes are detailed in the drive programming manual.

In the **[Complete settings] C 5 t** - menu, **[Command and reference] C r P** - submenu:

- **[Ref Freq Channel 1] F r 1**: is set on according to the communication source you can choose in the following table:

| Origin of the Control | Ref1 Channel Setting       |
|-----------------------|----------------------------|
| Ethernet module       | <b>[Com. Module] n E t</b> |

- **[Freq Switch Assign] r F C** is set to default value (**[Ref Freq 1 Config] F r 1**).
- **[Control Mode] C H C F**: defines if the drive operates in combined mode (reference and command from the same channel).

For the current example, **[Control Mode] C H C F** is adjusted to **[Not separ.] 5 , 11** as reference and control are originated from the communication network:

| Profile               | Ref1 Channel setting       |
|-----------------------|----------------------------|
| CiA 402 combined mode | <b>[Not separ.] 5 , 11</b> |
| CiA 402 separate mode | <b>[Separate] 5 E P</b>    |
| I/O profile           | <b>[I/O profile] , 0</b>   |

## Configuration of the Drive for Operation with CiA 402 Profile in Separate Mode

### Description

Alternate combinations are possible, see the drive programming manual for the list of possible settings.  
For example:

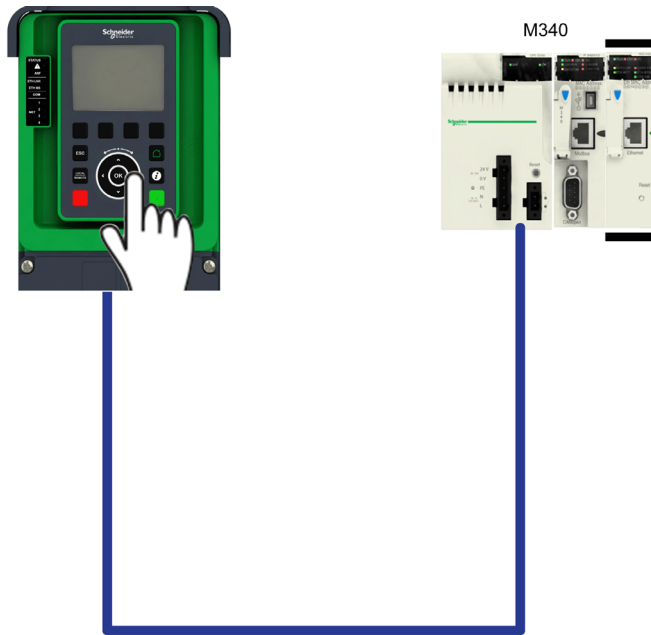

The drive is controlled from the communication but the reference value is adjusted on the display terminal. The control word comes from the controller and is written according to CiA 402 profile.

The settings are as shown in the table:

|                                  |                            |
|----------------------------------|----------------------------|
| [Ref Freq 1 Config] <i>F r 1</i> | [HMI] <i>H Π 1</i>         |
| [Control Mode] <i>C H C F</i>    | [Separate] <i>S E P</i>    |
| [Cmd channel 1] <i>C d 1</i>     | [Com. Module] <i>n E t</i> |

---

# Chapter 6

## Diagnostic and Troubleshooting

---

### What Is in This Chapter?

This chapter contains the following topics:

| Topic                        | Page |
|------------------------------|------|
| Fieldbus Status LEDs         | 148  |
| Connection for Fieldbus Mode | 150  |
| Fieldbus Functions Test      | 151  |
| Control-Signal Diagnostics   | 153  |

## Fieldbus Status LEDs

### LED Indicators

The following figure describes the LEDs status for fieldbus monitoring:

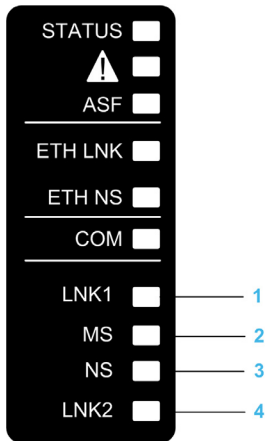

### LED Description

| Item | LED         | Description                |
|------|-------------|----------------------------|
| 1    | <b>LNK1</b> | Indicates port A activity. |
| 2    | <b>MS</b>   | Indicates module status.   |
| 3    | <b>NS</b>   | Indicates network status.  |
| 4    | <b>LNK2</b> | Indicates port B activity. |

### LNK1 and LNK2

These LEDs indicate the status of the Ethernet adapter ports:

| Color & status        | Description                     |
|-----------------------|---------------------------------|
| OFF                   | No link                         |
| Blinking Green/Yellow | Power on testing                |
| Green ON              | Link established at 100 Mbit/s  |
| Yellow ON             | Link established at 10 Mbit/s   |
| Blinking Green        | Fieldbus activity at 100 Mbit/s |
| Blinking Yellow       | Fieldbus activity at 10 Mbit/s  |

### NS: Network Status

This LED indicates the status of the fieldbus.

| Color & status     | Description                                                                  |
|--------------------|------------------------------------------------------------------------------|
| OFF                | The device does not have an IP address or powered off                        |
| Blinking Green/Red | Power on testing                                                             |
| Green ON           | A connection is established to control the command word.                     |
| Blinking Green     | Device has a valid IP, but no command word connection.                       |
| Red ON             | Duplicated IP                                                                |
| Blinking Red       | An established connection to control the command word is closed or timed out |

**MS: Module Status**

This LED indicates the status of the adapter

| <b>Color &amp; status</b> | <b>Description</b>                                              |
|---------------------------|-----------------------------------------------------------------|
| OFF                       | No power is supplied to the device                              |
| Blinking Green/Red        | Power on testing                                                |
| Green ON                  | The device is operating correctly.                              |
| Blinking Green            | Device has not been configured.                                 |
| Blinking red              | The device has detected a recoverable minor detected error.     |
| Red ON                    | The device has detected a non-recoverable major detected error. |

## Connection for Fieldbus Mode

### Description

If the product cannot be addressed via the fieldbus, first check the connections. The product manuals contains the technical data of the device and information on fieldbus and device installation.

Verify the following:

- Power connections to the device
- Fieldbus cable and fieldbus wiring
- Fieldbus connection to the device

## Fieldbus Functions Test

### Channels for Commands and Reference Values

All the drive commands and reference value parameters are managed on a channel-by-channel basis.

| Parameter Name                                                                      | Parameter Code                  |               |              |                 |                   |
|-------------------------------------------------------------------------------------|---------------------------------|---------------|--------------|-----------------|-------------------|
|                                                                                     | Taken Into Account by the Drive | Modbus Serial | CANopen      | Fieldbus Module | Ethernet Embedded |
| Control word                                                                        | <i>CNd</i>                      | <i>CNd1</i>   | <i>CNd2</i>  | <i>CNd3</i>     | <i>CNd5</i>       |
| Extended control word                                                               | <i>CNi</i>                      | <i>CNi1</i>   | <i>CNi2</i>  | <i>CNi3</i>     | <i>CNi5</i>       |
| Reference speed (rpm)                                                               | <i>LFRd</i>                     | <i>LFRd1</i>  | <i>LFRd2</i> | <i>LFRd3</i>    | <i>LFRd5</i>      |
| Reference frequency (0.1 Hz)                                                        | <i>LFR</i>                      | <i>LFR1</i>   | <i>LFR2</i>  | <i>LFR3</i>     | <i>LFR5</i>       |
| Reference value for torque control mode (0.1% of the nominal torque) <sup>(1)</sup> | <i>Ltr</i>                      | <i>Ltr1</i>   | <i>Ltr2</i>  | <i>Ltr3</i>     | <i>Ltr5</i>       |
| Reference value supplied by PI controller                                           | <i>PiSP</i>                     | <i>Pir1</i>   | <i>Pir2</i>  | <i>Pir3</i>     | <i>Pir5</i>       |
| Reference value supplied by analog multiplier function                              | <i>PFr</i>                      | <i>PFr1</i>   | <i>PFr2</i>  | <i>PFr3</i>     | <i>PFr5</i>       |
| <sup>(1)</sup> : If available                                                       |                                 |               |              |                 |                   |

### Fieldbus Monitoring Criteria

The fieldbus is monitored according to the protocol-specific criteria.

| Protocol        | Criteria                                                                                                                                                      | Related Detected Error                                                                                                |
|-----------------|---------------------------------------------------------------------------------------------------------------------------------------------------------------|-----------------------------------------------------------------------------------------------------------------------|
| Ethernet module | FDR detected error<br>IP address duplication detected error<br>Adjustable time-out for received control word (I/O scanning or messaging)<br>Fieldbus overload | <b>[Fieldbus Error]</b> <i>EPF2</i><br><b>[FDR 2 Error]</b> <i>Fdr2</i><br><b>[Fieldbus Com Interrupt]</b> <i>CnF</i> |

### Monitoring of Communication Channels

Communication channels are monitored if they are involved in one of the following parameters:

- The control word (**[Cmd Register]** *CNd*) from the active command channel
- The control word containing the command switch (bit configured on **[Cmd switching]** *CC5*)
- The control word containing the switch for reference value 1'1B (bit configured on **[Ref 1B switching]** *rCb*)
- The control word containing the switch for reference value 1'2 (bit configured on **[Freq Switch Assign]** *rFL*)
- The reference frequency or reference speed (**[Ref Frequency]** *LFR* or LFRD: Nominal speed value) from the active channel for reference value
- Summing reference frequency or reference speed (**[Ref Frequency]** *LFR* or LFRD: Nominal speed value) 2 (assigned to **[Summing Input 2]** *SA2*)
- Summing reference frequency or reference speed (**[Ref Frequency]** *LFR* or LFRD: Nominal speed value) 3 (assigned to **[Summing Input 3]** *SA3*)
- Subtracting reference frequency or reference speed (**[Ref Frequency]** *LFR* or LFRD: Nominal speed value) 2 (assigned to **[Subtract Ref Freq 2]** *dR2*)
- Subtracting reference frequency or reference speed (**[Ref Frequency]** *LFR* or LFRD: Nominal speed value) 3 (assigned to **[Subtract Ref Freq 3]** *dR3*)
- The reference value given by the PID controller (PISP)
- The PID controller feedback (**[AI Virtual 1]** *Ai1*)

- The multiplication coefficient of the reference values (**[Multiplying coeff.] PFr**) 2 (assigned to **[Ref Freq 2 Multiply] PFr2**)
- The multiplication coefficient of the reference values (**[Multiplying coeff.] PFr**) 3 (assigned to **[Ref Freq 3 Multiply] PFr3**)

As soon as one of these parameters has been written once to a communication channel, it activates monitoring for that channel.

If a communication warning is sent (in accordance with the protocol criteria) by a monitored port or fieldbus module, the drive triggers a communication interruption.

The drive reacts according to the communication interruption configuration (operating state Fault, maintenance, fallback, and so on)

If a communication warning occurs on a channel that is not being monitored, the drive does not trigger a communication interruption.

### Enabling of Communication Channels

A communication channel is enabled once all the parameters involved have been written at least one time. The drive is only able to start if all channels involved in command and reference value are enabled.

For example:

A drive in DSP402 profile is connected to an active communication channel.

It is mandatory to write at least 1 time the reference value and the command in order to switch from 4-Switched on to 5-Operation enabled state.

A communication channel is disabled:

- In the event of a communication warning.
- In forced local mode.

**NOTE:** On exiting forced local mode:

- The drive copies the run commands, the direction, and the forced local reference value to the active channel (maintained).
- Monitoring of the active channels for the command and reference value resumes following a time delay **[Time-out forc. local] FLot**.
- Drive control only takes effect once the drive has received the reference and the command from the active channels.

## Control-Signal Diagnostics

### Introduction

On the display terminal, the **[Display] Π ο η -**, **[Communication map] Γ Π Π -** submenu can be used to display control-signal diagnostic information between the drive and the controller:

- Active command channel **[Command Channel] Γ Π Δ Γ**
- Value of the control word **[Cmd Register] Γ Π Δ** from the active command channel **[Command Channel] Γ Π Δ Γ**
- Active reference frequency channel **[Ref Freq Channel] ρ F Γ Γ**
- Value of the reference frequency **[Pre-Ramp Ref Freq] F ρ H** from the active target channel **[Ref Freq Channel] ρ F Γ Γ**
- Value of the operating state word **[CIA402 State Reg] E Λ Η**
- Specific data for all available fieldbuses are in dedicated submenus.
- In the **[Command word image] Γ W ι -** submenu: control words from all channels
- In the **[Freq. ref. word map] ρ W ι -** submenu: reference frequency values produced by all channels

### Control Word Display

The **[Command Channel] Γ Π Δ Γ** parameter indicates the active command channel.

The **[Cmd Register] Γ Π Δ** parameter indicates the hexadecimal value of the control word (CMD) used to control the drive.

The **[Command word image] Γ W ι -** submenu (**[COM. Module cmd.] Γ Π Δ ε**) parameter is used to display the hexadecimal value of the control word from the fieldbus module.

### Reference Frequency Display

The **[Ref Freq Channel] ρ F Γ Γ** parameter indicates the active channel for reference frequency.

The **[Ref Frequency] L F ρ** parameter indicates the value (in 0.1 Hz units) of the reference frequency used to control the drive.

The **[Freq. ref. word map] ρ W ι -** submenu (**[COM Module Ref Freq] L F ρ ε**) parameter is used to display the value (in 0.1 Hz units) of the reference frequency from the fieldbus.

### Operating State Word Display

The **[CIA402 State Reg] E Λ Η** parameter gives the value of the operating state word (ETA).

The table provides the bit details of **E Λ Η** parameter:

| Bit       | Description                                      |
|-----------|--------------------------------------------------|
| DRIVECOM  | Status word                                      |
| Bit0 = 1  | Ready to switch on                               |
| Bit1 = 1  | Switched on                                      |
| Bit2 = 1  | Operation enabled                                |
| Bit3 = 1  | Operating state fault                            |
| Bit4 = 1  | Power stage is switched on                       |
| Bit5 = 0  | Quick stop                                       |
| Bit6 = 1  | Switch on disabled                               |
| Bit7 = 1  | Warning                                          |
| Bit8 = 1  | Drivecom reserved                                |
| Bit9 = 0  | Forced local mode in progress                    |
| Bit10 = 1 | Reference value reached (steady state)           |
| Bit11 = 1 | Reference value exceeded (< LSP or > HSP)        |
| Bit12     | Reserved                                         |
| Bit13     | Reserved                                         |
| Bit14 = 1 | Stop imposed via <b>STOP</b> key                 |
| Bit15 = 0 | Motor rotation in forward direction (or stopped) |





## A

### Abbreviations

Req. = Required

Opt. = Optional

## C

### CAN

Controller Area Network is an internally standardized serial bus system

### COB

Communication Object. A unit of transportation in a CAN network. Data must be sent across a CAN Network inside a COB. There are 2048 different COB's in a CAN network. A COB can contain at most 8 bytes of data.

### COB ID

Each COB is uniquely identified in a CAN network by a number called the COB Identifier (COB-ID).

## D

### Display terminal

The display terminal menus are shown in square brackets.

For example: **[Communication]**

The codes are shown in round brackets.

For example: *( C a 1 )*

Parameter names are displayed on the display terminal in square brackets.

For example: **[Fallback Speed]**

Parameter codes are displayed in round brackets.

For example: *( L F F )*

### DP

Decentralized Periphery

### DPWS

Device Profile for Web Service

## E

### Error

Discrepancy between a detected (computed, measured, or signaled) value or condition and the specified or theoretically correct value or condition.

## F

### Factory setting

Factory settings when the product is shipped

### Fault

Fault is an operating state. If the monitoring functions detect an error, a transition to this operating state is triggered, depending on the error class. A "Fault reset" is required to exit this operating state after the cause of the detected error has been removed. Further information can be found in the pertinent standards such as IEC 61800-7, ODVA Common Industrial Protocol (CIP).

### Fault Reset

A function used to restore the drive to an operational state after a detected error is cleared by removing the cause of the error so that the error is no longer active.

**L****LSB**

Least Significant Byte

**M****Monitoring function**

Monitoring functions acquire a value continuously or cyclically (for example, by measuring) in order to check whether it is within permissible limits. Monitoring functions are used for error detection.

**MS0, MS1**

Number of a master in the network.

**MSB**

Most Significant Byte

**N****NMT**

Network Management. One of the service elements of the application layer in the CAN Reference Model. The NMT serves to configure, initialize, and handle detected errors in a CAN network.

**P****Parameter**

Device data and values that can be read and set (to a certain extent) by the user.

**PDO**

Process Data Object

**PELV**

Protective Extra Low Voltage, low voltage with isolation. For more information: IEC 60364-4-41

**PLC**

Programmable logic controller

**PNO**

PROFIBUS Nutzerorganisation e.V. (PROFIBUS User organization).

**Power stage**

The power stage controls the motor. The power stage generates current for controlling the motor.

**Q****QoS**

Quality of Service

**Quick Stop**

The quick Stop function can be used for fast deceleration of a movement as a response to a detected error or via a command.

**R****RPDO**

Receive PDO

**S****SNMP**

Simple Network Management Protocol

**SNTP**

Simple Network Time Protocol

---

**SYNC**

Synchronization Object

**T****TPDO**

Transmit PDO

**W****Warning**

If the term is used outside the context of safety instructions, a warning alerts to a potential problem that was detected by a monitoring function. A warning does not cause a transition of the operating state.

**Z****Zone of operation**

This term is used in conjunction with the description of specific hazards, and is defined as it is for a **hazard zone** or **danger zone** in the EC Machinery Directive (2006/42/EC) and in ISO 12100-1.





