



FAQ

Frequently Asked Question

Presented by: Universal Enclosures - Country technical support. January 2018.

Standard Universal Enclosures locks for Thalassa PLM enclosures.

Serrures standards pour Enveloppes Thalassa PLM.

DANGER

RISK OF ELECTRIC SHOCK, EXPLOSION OR ARC FLASH.

- Before any intervention, the equipment or product must be disconnected from the mains.

Not complying can cause death, or serious injury.

- Read the instructions manual before any installation or maintenance operations.
- The installation or maintenance operations can only be carried out by specialized and authorized personnel.
- The repairs that may be necessary can only be carried out by specialized and authorized personnel used original spare parts.
- During installation, maintenance or repair use **IPE** (individual protective equipment) to prevent injury.

DANGER

RISQUE DE CHOC ELECTRIQUE, D'EXPLOSION OU D'ARC ELECTRIQUE.

- Avant toute intervention, déconnectez l'équipement ou le produit du secteur.

Tout manquement peut entraîner des blessures, voir la mort.

- Lire la notice technique avant toute opération d'installation ou de maintenance.
- Les opérations d'installations ou de maintenances ne doivent être faites que par du personnel qualifié et autorisé.
- Les réparations qui sont nécessaires ne doivent être faites que par du personnel qualifié et autorisé avec des pièces de rechanges d'origine.
- Pendant l'installation, la maintenance ou la réparation utilisé des équipements de protection individuel, **EPI** pour éviter les dommages corporels.

NSYPLM3025G and NSYPLM3025TG: Locks and inserts.

Part Number Référence	DESIGNATION	Picture Image
<p>Spare parts for replacement of standard handle. Delivered with all the parts required to change the lock.</p> <p>Other components are in the set because they are used elsewhere.</p>		
 <p>For NSYPLM3020*</p> <p>Product composition: NSYCDBPLM</p>		

NSYPLM32G and NSYPLM32TG: Locks and inserts.

Part Number Référence	DESIGNATION	Picture Image
<p>Spare parts for replacement of standard handle. Delivered with all the parts required to change the lock.</p> <p>Other components are in the set because they are used elsewhere.</p> <p>► Note: Original cam is in accessories bag NSYTK1, while this one included here is 0,8 mm higher. This does not prevent the operation of the lock ◀ See page 17</p>		
 <p>For NSYPLM32*</p> <p>Product composition: NSYCDBPLM</p>		

NSYPLM**(43 – 54 – 64 – 75 – 86)**G and TG: Locks and inserts.

Part Number Référence	DESIGNATION	Picture Image
--------------------------	-------------	------------------

Spare parts for replacement of standard handle. Delivered with all the parts required to change the lock.

Other components are inside the set because they are used elsewhere.

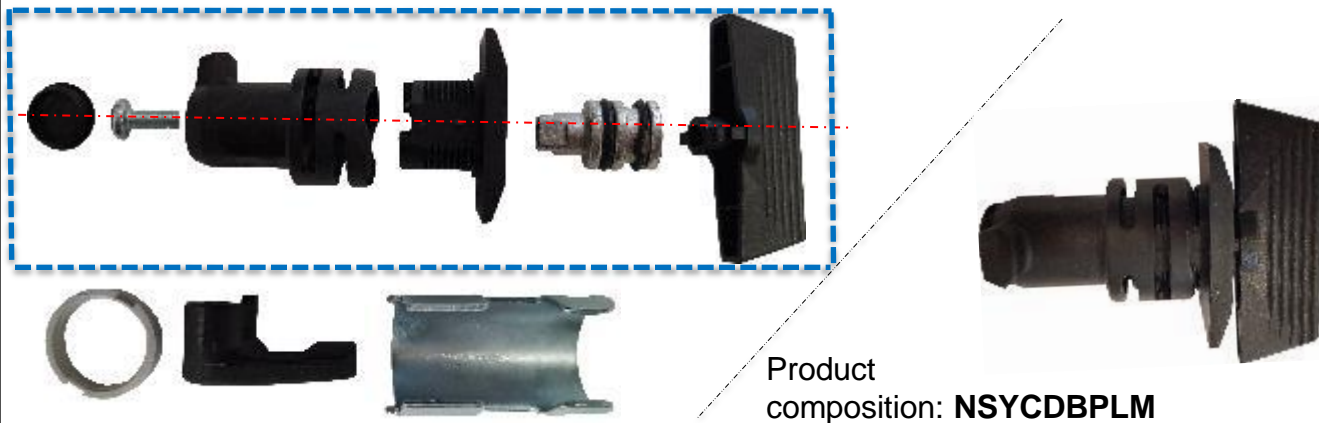

NSYDBP	Double barre 3 mm plastic key	
NSYDTBCRN	Standard double barre 3mm rotor + key and screws	

To change the standard 3 mm double barrel by other inserts shapes.

NSYTC6CRN 6 mm male square		
NSYTC7CRN 7 mm male square		

NSYPLM**(32 – 43 – 54 – 64 – 75 – 86)**G and TG: Locks and inserts.

Part Number Référence	DESIGNATION	Picture Image
--------------------------	-------------	------------------

To change the standard 3mm double barrel by other inserts shapes.

NSYTC8CRN
8 mm male square



NSYTT6CRN
6,5 mm male triangle

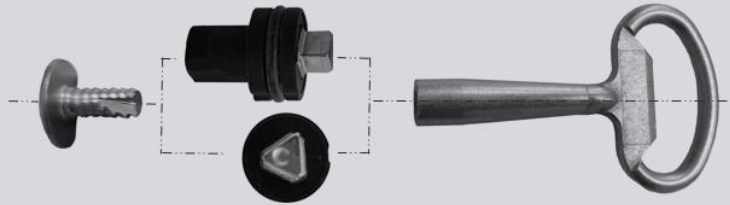



NSYTT8CRN
8 mm male triangle

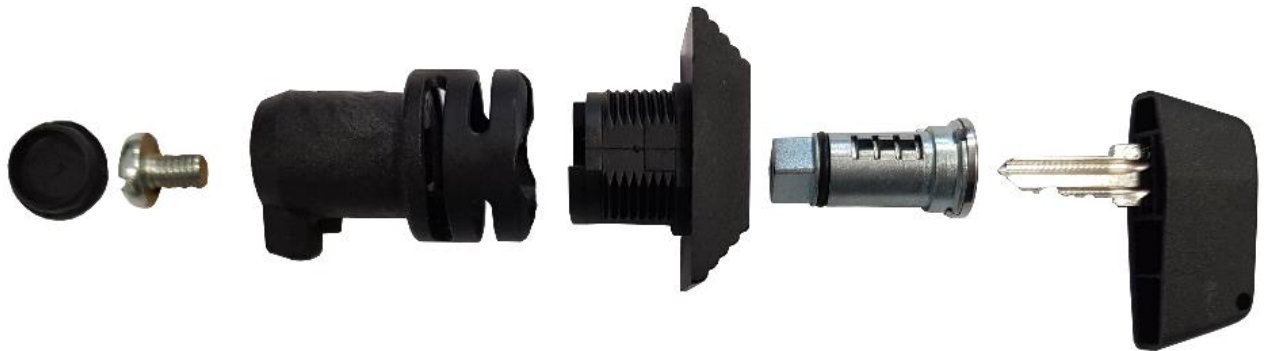

To change the standard 3mm double barrel by locks with keys



Product composition: NSYTL405PLM / NSYTL220PLM

<p>NSYTL405PLM</p> <p>NSYTL220PLM</p>	<p>With key 405</p> 	<p>With key 220</p> 
---------------------------------------	---	--





NSYPLM**(32 – 43 – 54 – 64 – 75 – 86)**G and TG: Locks and inserts.

Part Number Référence	DESIGNATION	Picture Image
--------------------------	-------------	------------------

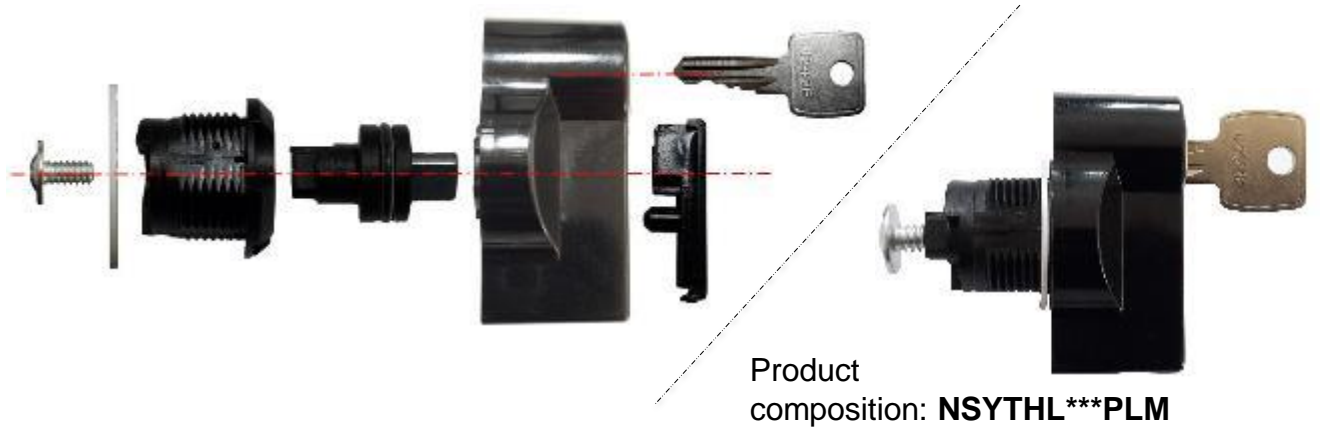
Replacement for locking handle with cylindrical barrel, delivered with all the parts required to change the lock. ► Reuse current cam and nut ◀

If cam or nut are missing, worn or broken order accessories bag **NSYTK1**. See page 17



NSYTHL1242EPLM	Complete Handle with Key 1242 E	
NSYTHL405PLM	Complete Handle with Key 405	
NSYTHL421PLM	Complete Handle with Key 421	
NSYTHL455PLM	Complete Handle with Key 455	
NSYTHL610PLM	Complete Handle with Key 610	



NSYPLM**(32 – 43 – 54 – 64 – 75 – 86)**G and TG: Locks and inserts.

Part Number Référence	DESIGNATION	Picture Image
--------------------------	-------------	------------------

Replacement for locking handle with cylindrical barrel, delivered with all the parts required to change the lock. ► Reuse current cam and nut ◀

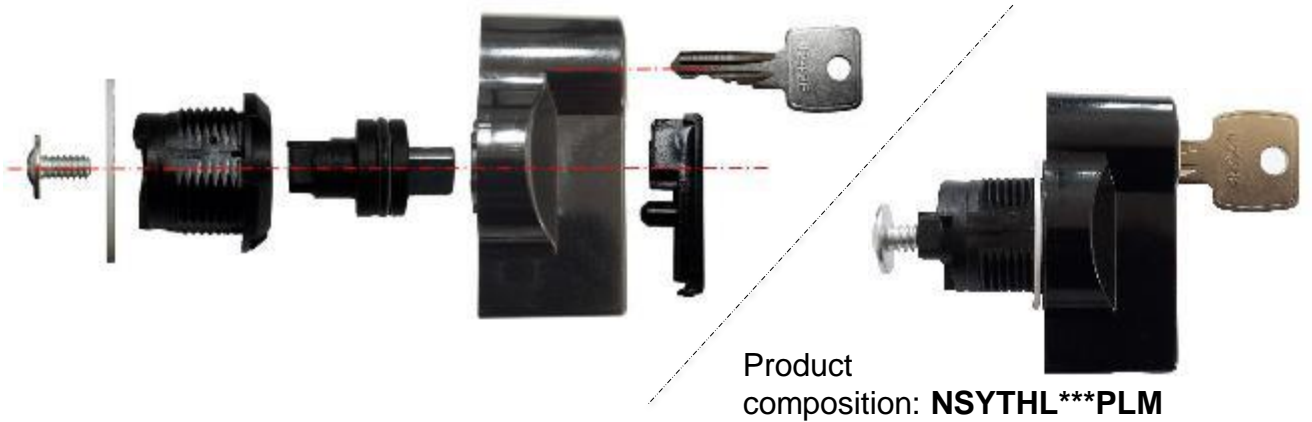
If cam or nut are missing, worn or broken order accessories bag **NSYTK1**. See page 17





NSYTHL2331APLM	Complete Handle with Key 2331 A	
NSYTHL2433APLM	Complete Handle with Key 2433 A	
NSYTHL3113APLM	Complete Handle with Key 3113 A	
NSYTHL3131APLM	Complete Handle with Key 3131 A	
NSYTHPLM	Complete Manual handle	





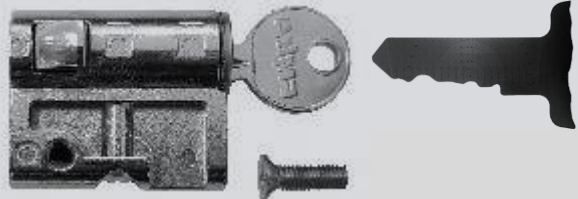

NSYPLM**(43 – 54 – 64 – 75 – 86)**VG and TVG: inserts.

Part Number Référence	DESIGNATION	Picture Image
<p>Replacement for standard insert or transformation of standard insert. ► Reuse current handle, cam and rod system ◀ For Handle replacement consult us.</p>		
NSYTL1242EME	Barrel for key 1242E.	
NSYTDB5ME	5 mm double bar.	
NSYTC6ME	6 mm male square.	
NSYTC7ME	7 mm male square.	
NSYTC8ME	8 mm male square.	
NSYTT6ME	6,5 male triangle.	

NSYPLM**(43 – 54 – 64 – 75 – 86)**VG and TVG: inserts.

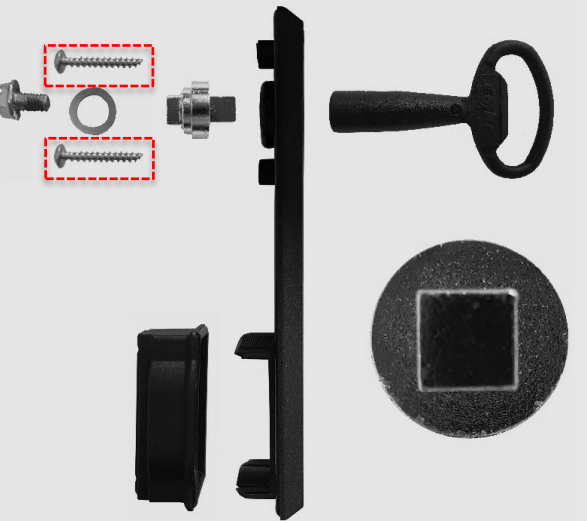
Part Number Référence	DESIGNATION	Picture Image
<p>Replacement for standard insert or transformation of standard insert. ► Reuse current handle, cam and rod system ◀ For Handle replacement consult us.</p>		
NSYTT8ME	8 mm male triangle.	
NSYTCL405ME	Barrel for key 405.	
NSYTLRME	Reinforced key and barrel.	
NSYTLJISME	JIS key and barrel.	<p style="text-align: center;">View Not Available</p>
NSYTMME	Manual.	

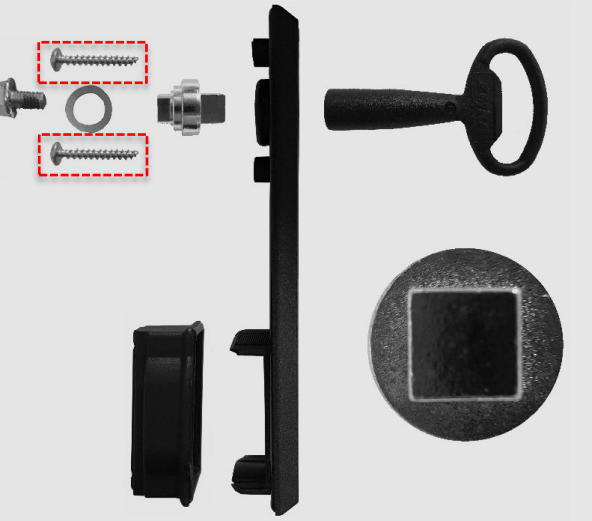
NSYPLM108 / NSYPLM108T : locks and inserts.

Part Number Référence DESIGNATION	Picture Image
<p>Replacement or transformation of standard insert with other shape inserts.</p> <p>► Reuse cam and rod system ◀</p>	
 <p>NSYTDB5PL Standard lock 5 mm double barre insert.</p>	 <p>NSYTC6PL 6 mm male square.</p> <p> REUSE CURRENT</p>
 <p>NSYTC7PL 7 mm male square.</p> <p> REUSE CURRENT</p>	 <p>NSYTC8PL 8 mm male square.</p> <p> REUSE CURRENT</p>

NSYPLM108 / NSYPLM108T : locks and inserts.

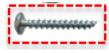
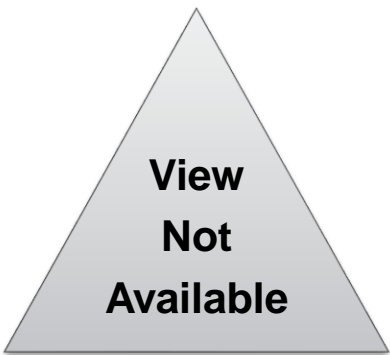
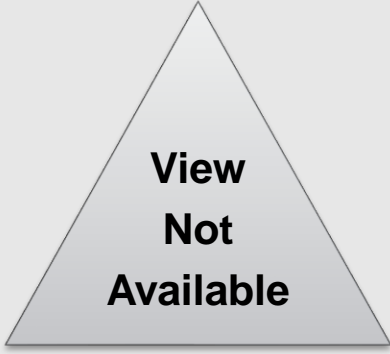
Part Number Référence DESIGNATION	Picture Image
<p>Replacement or transformation of standard insert with other shape inserts.</p> <p>▶ Reuse cam and rod system ◀</p>	
 <p>NSYTT6PL 6,5 mm male triangle.</p> <p> REUSE CURRENT</p>	 <p>View Not Available</p> <p>NSYTT7PL 7 mm male triangle.</p>
 <p>View Not Available</p> <p>NSYTT8PL 8 mm male triangle.</p>	

NSYPLM108 / NSYPLM108T : locks and inserts.

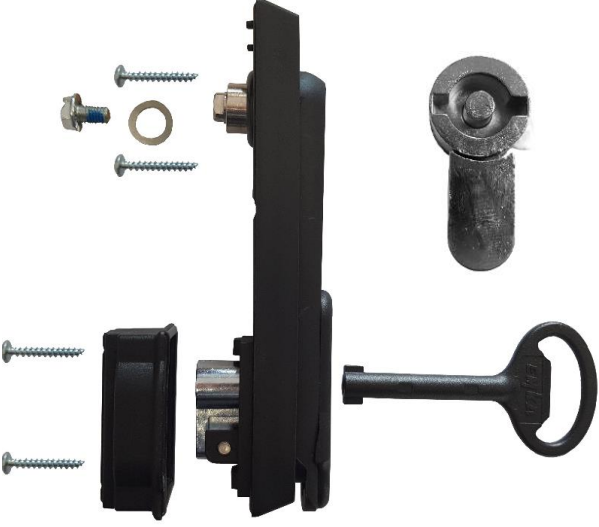
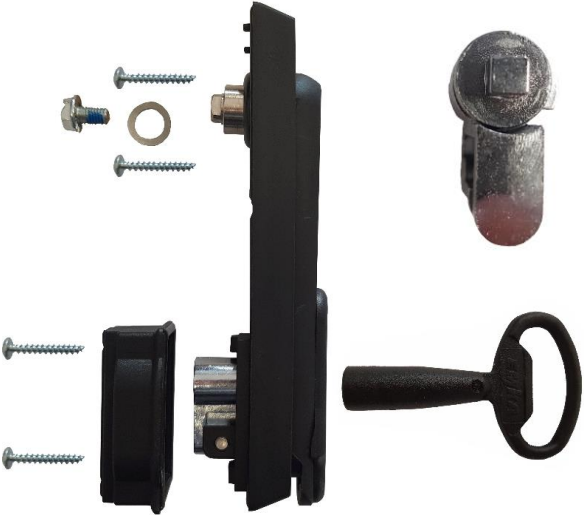
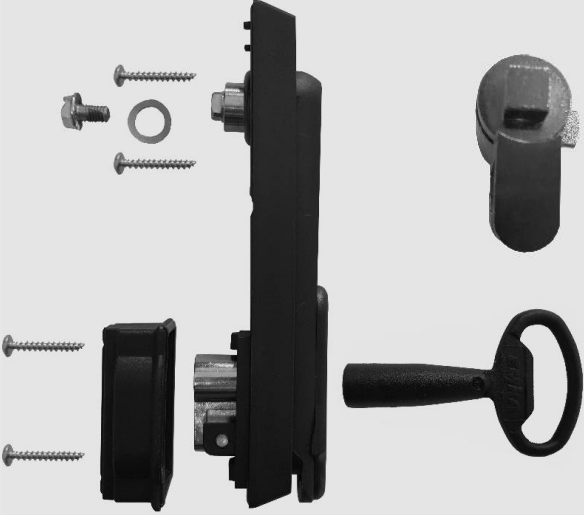
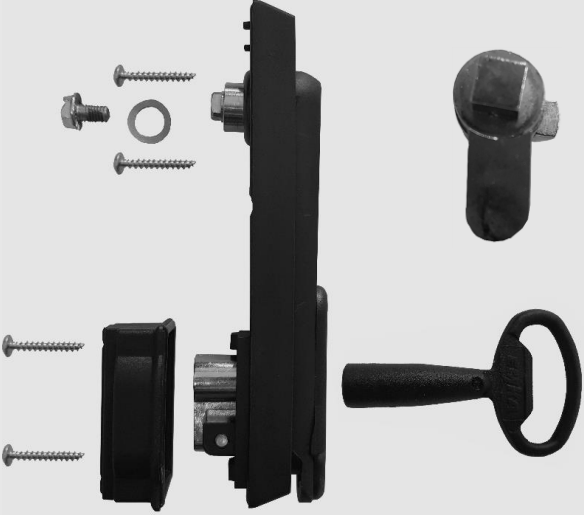
Part Number Référence DESIGNATION	Picture Image
<p>Replacement for transformation of retractable handle. ▶ Reuse cam and rod system ◀</p>	
 <p>NSYTEDB5PL 5 mm double barre.</p>	 <p>NSYTEC6PL 6 mm male square.</p>
 <p>NSYTEC7PL 7 mm male square.</p>	 <p>NSYTEC8PL 8 mm male square.</p>



NSYPLM108 / NSYPLM108T : locks and inserts.

Part Number Référence DESIGNATION	Picture Image
<p>Replacement for transformation of retractable handle.</p> <p>▶ Reuse cam and rod system ◀</p>	
 <p>NSYTET6PL 6,5 mm male triangle.</p>	 <p>NSYTET7PL 7 mm male triangle.</p>
 <p>NSYTET8PL 8 mm male triangle.</p>	

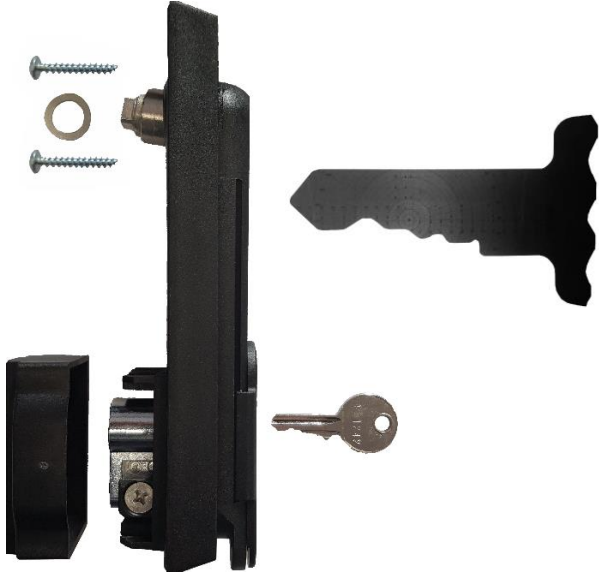
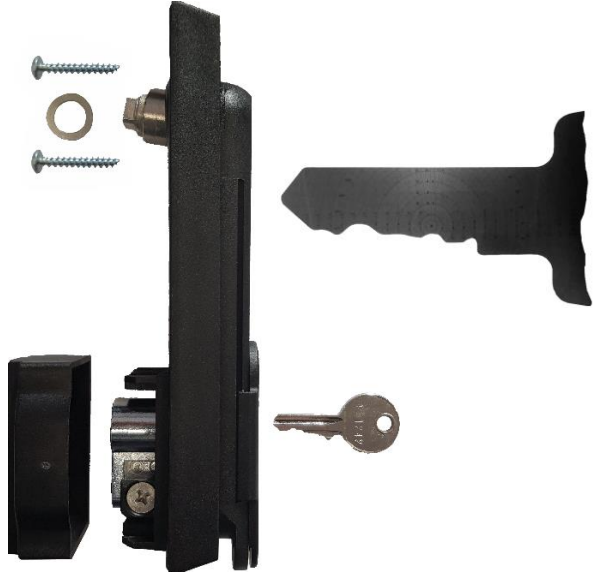
NSYPLM108 / NSYPLM108T : locks and inserts.

Part Number Référence DESIGNATION	Picture Image
<p>Replacement for transformation of retractable handle. ▶ Reuse cam and rod system ◀</p>	
 <p>NSYTEL1242EPL Lock key 1242 E.</p>	 <p>NSYTEL405PL Lock key 405.</p>
<p style="text-align: center;">View Not Available</p> <p>NSYTERPL Reinforced key and barrel.</p>	<p style="text-align: center;">View Not Available</p> <p>NSYTELJISPL JIS key and barrel.</p>

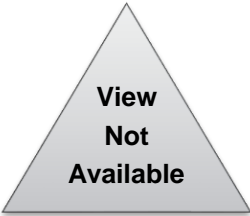
NSYPLM108 / NSYPLM108T : locks and inserts.

Part Number Référence DESIGNATION	Picture Image
<p>Replacement for transformation of retractable handle. ▶ Reuse cam and rod system◀</p>	
<p style="text-align: center;"> View Not Available</p> <p>NSYTELFACPL FAC key and barrel.</p>	 <p>NSYTEMPL Manual.</p>

Padlocking accessories.

Part Number
Référence
DESIGNATION

Padlocking accessories.

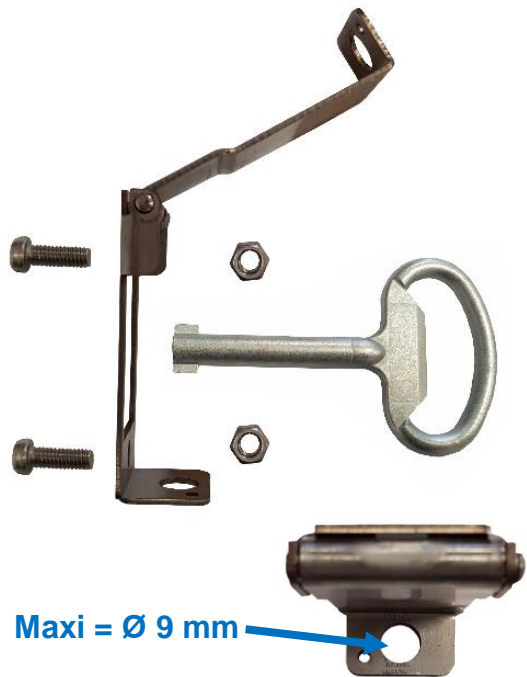

NSYKPLM

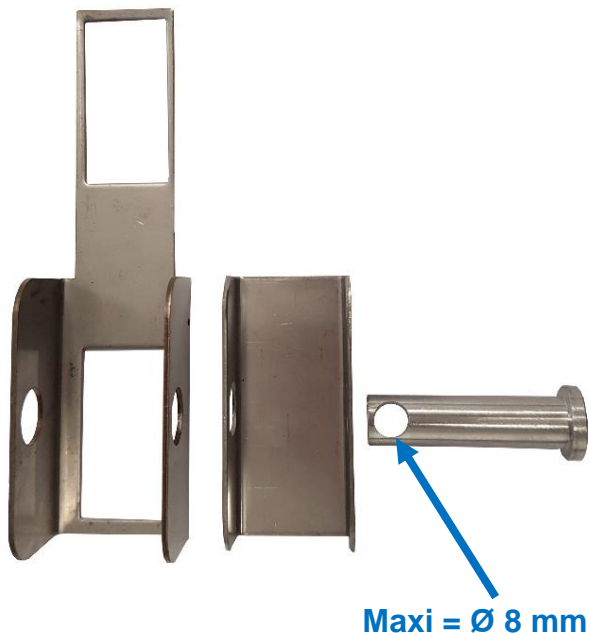

NSYBCPL

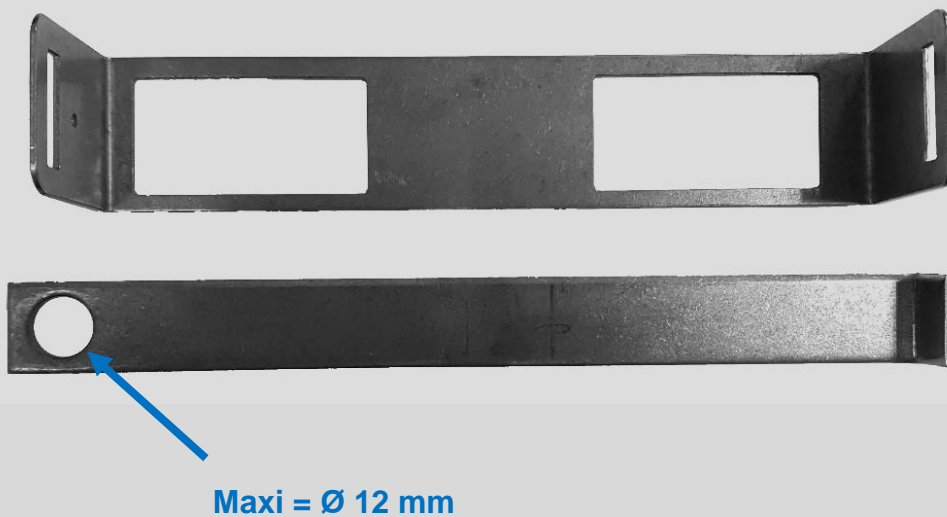

NSYBCME



Composition of accessories bag NSYTK1



Cam



Cam



Cam



Cam



Cam for PLM



Body for handle



Nut



Washer



Tool



Nut

Life Is On

Schneider
 Electric