

A circuit supplying a motor may include one, two, three or four switchgear or controlgear devices fulfilling one or more functions.

**When a number of devices are used, they must be coordinated to ensure optimum operation of the motor.**

Protection of a motor circuit involves a number of parameters that depend on:

- the application (type of machine driven, operating safety, starting frequency, etc.)
- the level of service continuity imposed by the load or the application
- the applicable standards to ensure protection of life and property.

The necessary electrical functions are of very different natures:

- protection (motor-dedicated for overloads)
- control (generally with high endurance levels)
- isolation.

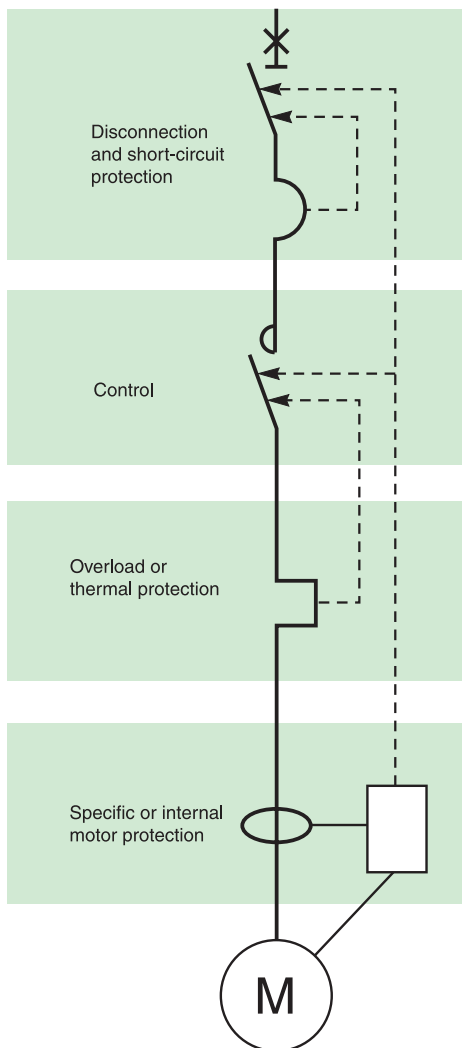

### Protection functions

#### Disconnection functions:

- Isolate a motor circuit prior to maintenance operations.

#### Short-circuit protection:

Protect the starter and the cables against major overcurrents ( $> 10 I_n$ ).

#### Control:

Start and stop the motor, and, if applicable:

- gradual acceleration
- speed control.

#### Overload protection:

Protect the starter and the cables against minor overcurrents ( $< 10 I_n$ ).

#### Additional specific protection:

- limitative fault protection (while the motor is running)
- preventive fault protection (monitoring of motor insulation with motor off).

#### Overloads ( $I < 10 I_n$ ).

An overload may be caused by:

- an electrical problem, for instance on the mains (loss of a phase, voltage outside tolerances, etc.)
- a mechanical problem, for instance excessive torque due to abnormally high demands by the process or motor damage (bearing vibrations, etc.)

A further consequence of these two origins is excessively long starting.

#### Impedant short-circuit ( $10 < I < 50 I_n$ )

Deterioration of motor-winding insulation is the primary cause.

#### Short-circuit ( $I > 50 I_n$ )

This type of fault is relatively rare. A possible cause may be a connection error during maintenance.

#### Overload protection

Thermal relays provide protection against this type of fault. They may be:

- integrated in the short-circuit protective device
- separate.

#### Short-circuit protection

This type of protection is provided by a circuit breaker.

#### Protection against insulation faults

This type of protection may be provided by:

- a residual current device (RCD)
- an insulation monitoring device (IMD).

### Applicable standards

A circuit supplying a motor must comply with the general rules set out in IEC standard 60947-4-1 and in particular with those concerning contactors, motor starters and their protection as stipulated in IEC 60947-4-1, notably:

- coordination of the components of the motor circuit
- trip class for thermal relays
- contactor utilisation categories
- coordination of insulation.

### Coordination of the components of the motor circuit

#### Two types of coordination

The standard defines tests at different current levels. The purpose of these tests is to place the switchgear and controlgear in extreme conditions. Depending on the state of the components following the tests, the standard defines two types of coordination:

##### ■ type 1:

Deterioration of the contactor and the relay is acceptable under two conditions:

- no danger to operating personnel
- no danger to any components other than the contactor and the relay

##### ■ type 2:

Only minor welding of the contactor or starter contacts is permissible and the contacts must be easily separated.

- following type-2 coordination tests, the switchgear and controlgear functions must be fully operational.

#### Which type of coordination is needed?

Selection of a type of coordination depends on the operating conditions encountered.

The goal is to achieve the best balance between the user's needs and the cost of the installation.

##### ■ type 1:

- qualified maintenance service
- low cost of switchgear and controlgear
- continuity of service is not imperative or may be ensured by simply replacing the faulty motor drawer

##### ■ type 2:

- continuity of service is imperative
- limited maintenance service
- specifications stipulating type 2.

### The different test currents

#### "Ic", "r" and "Iq" test currents

To qualify for type-2 coordination, the standard requires three fault-current tests to check that the switchgear and controlgear operates correctly under overload and short-circuit conditions.

#### "Ic" current (overload $I < 10 I_n$ )

The thermal relay provides protection against this type of fault, up to the  $I_c$  value (a function of  $I_m$  or  $I_{sd}$ ) defined by the manufacturer.

IEC standard 60947-4-1 stipulates two tests that must be carried out to guarantee coordination between the thermal relay and the short-circuit protective device:

- at  $0.75 I_c$ , only the thermal relay reacts
- at  $1.25 I_c$ , the short-circuit protective device reacts.

Following the tests at  $0.75$  and  $1.25 I_c$ , the trip characteristics of the thermal relay must be unchanged. Type-2 coordination thus enhances continuity of service. The contactor may be closed automatically following clearing of the fault.

#### "r" current

(Impedant short-circuit  $10 < I < 50 I_n$ )

The primary cause of this type of fault is the deterioration of insulation. IEC standard 60947-4-1 defines an intermediate short-circuit current "r". This test current is used to check that the protective device provides protection against impedant short-circuits.

There must be no modification in the original characteristics of the contactor and the thermal relay following the test.

The circuit breaker must trip in  $\leq 10$  ms for a fault current  $\geq 15 I_n$ .

Operational current $I_e$ (AC3) of the motor (in A)	"r" current (kA)
$I_e \leq 16$	1
$16 < I_e \leq 63$	3
$63 < I_e \leq 125$	5
$125 < I_e \leq 315$	10
$315 < I_e < 630$	18

#### "Iq" current

(short-circuit  $I > 50 I_n$ )

This type of fault is relatively rare. A possible cause may be a connection error during maintenance.

Short-circuit protection is provided by devices that open quickly.

IEC standard 60947-4-1 defines the "Iq" current as generally  $\geq 50$  kA.

The "Iq" current is used to check the coordination of the switchgear and controlgear installed on a motor supply circuit.

Following this test under extreme conditions, all the coordinated switchgear and controlgear must remain operational.

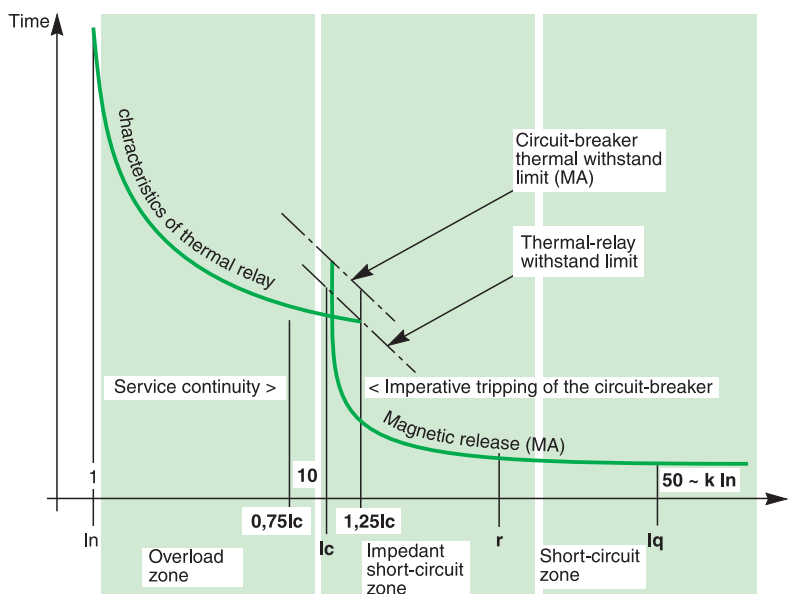

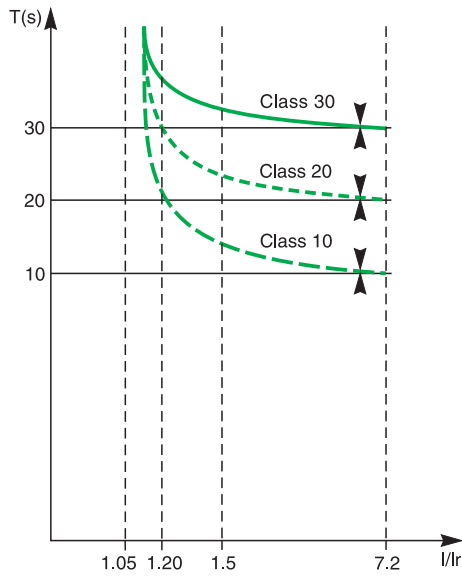

Trip class of a thermal relay.

### Trip class of a thermal relay

The four trip class of a thermal relay are 10 A, 10, 20 and 30 (maximum tripping times at 7.2 Ir).

Classes 10 and 10 A are the most commonly used. Classes 20 and 30 are reserved for motors with difficult starting conditions.

The diagram and the table opposite can be used to select a thermal relay suited to the motor starting time.

Class	1.05 Ir	1.2 Ir	1.5 Ir	7.2 Ir
10 A	$t > 2 \text{ h}$	$t < 2 \text{ h}$	$t < 2 \text{ min.}$	$2 \leq t \leq 10 \text{ s}$
10	$t > 2 \text{ h}$	$t < 2 \text{ h}$	$t < 4 \text{ min.}$	$4 \leq t \leq 10 \text{ s}$
20	$t > 2 \text{ h}$	$t < 2 \text{ h}$	$t < 8 \text{ min.}$	$6 \leq t \leq 20 \text{ s}$
30	$t > 2 \text{ h}$	$t < 2 \text{ h}$	$t < 12 \text{ min.}$	$9 \leq t \leq 30 \text{ s}$

### The four utilisation categories of contactors (AC1 to AC4)

The four utilisation categories of contactors (AC1 to AC4) determine the operating frequency and endurance of a contactor. The category depends on the type of load. If the load is a motor, the category also depends on the service classification.

#### Main characteristics of the controlled electrical circuits and applications

Category	Type of load	Contactor usage	Typical applications
AC1	No-inductive ( $\cos \varphi 0.8$ )	Energisation	Heating, distribution
AC2	Slip-ring motors ( $\cos \varphi 0.65$ )	Starting Switching off during running Regenerative braking Inching	Wire drawing machines
AC3	Squirrel-cage motors ( $\cos \varphi 0.45$ for $I_e \leq 100A$ ) ( $\cos \varphi 0.35$ for $I_e > 100A$ )	Starting Switching off during running	Compressors, lifts, mixing Pumps, escalators, fans, Conveyers, air-conditioning
AC4	Squirrel-cage motors ( $\cos \varphi 0.45$ for $I_e \leq 100A$ ) ( $\cos \varphi 0.35$ for $I_e > 100A$ )	Starting Switching off during running Regenerative braking Plugging Inching	Printing machines, wire

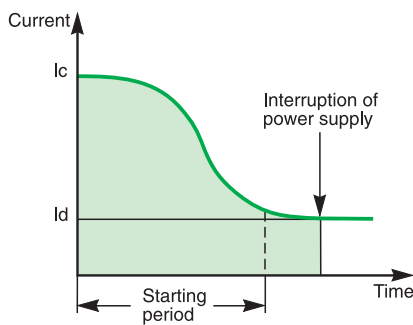

AC3 utilisation category. The contactor interrupts the rated current of the motor.

#### AC3 utilisation category

This category covers asynchronous squirrel-cage motors that are switched off during running. This is the most common situation (85 % of all cases).

The control device establishes the starting current and interrupts the rated current at a voltage equal to approximately one-sixth of the rated value.

Current interruption is carried out with no difficulty.

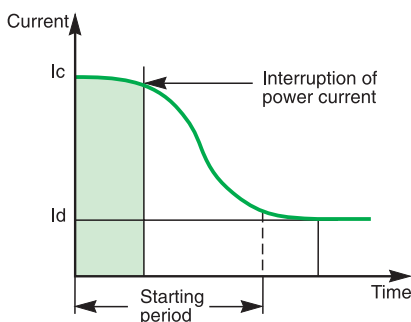

AC4 utilisation category. The contactor must be capable of interrupting the starting current  $I_d$ .

#### AC4 utilisation category

This category covers asynchronous squirrel-cage or slip-ring motors capable of operating under regenerative-braking or inching (jogging) conditions.

The control device establishes the starting current and is capable of interrupting the starting current at a voltage that may be equal to that of the mains.

Such difficult conditions require oversizing of the control and protective devices with respect to category AC3.

# Protection of motor circuits

## Using the circuit breaker/contactors coordination tables

### Subtransient phenomena related to direct on-line starting of asynchronous motors

Subtransient phenomena occurring when starting squirrel-cage motors:  
A squirrel-cage motor draws a high inrush current during starting. This current is related to the combined influence of two parameters:

- the high inductance of the copper stator winding
- the magnetisation of the iron core of the stator.

$I_n$ : current drawn by the motor at full rated load (in A rms)

$I_d$ : current drawn by the motor during starting (in A rms)

$I_d''$ : subtransient current generated by the motor when it is energised.  
This very short subtransient phenomenon is expressed as  $k \times I_d \times r^2$  (in A peak).

$t_d$ : motor starting time, from 0.5 to 30 seconds depending on the application.

$t_d''$ : duration of the subtransient current, from 0.010 to 0.015 seconds when the motor is energised.

$I_{rm}$ : magnetic setting of the circuit breakers.

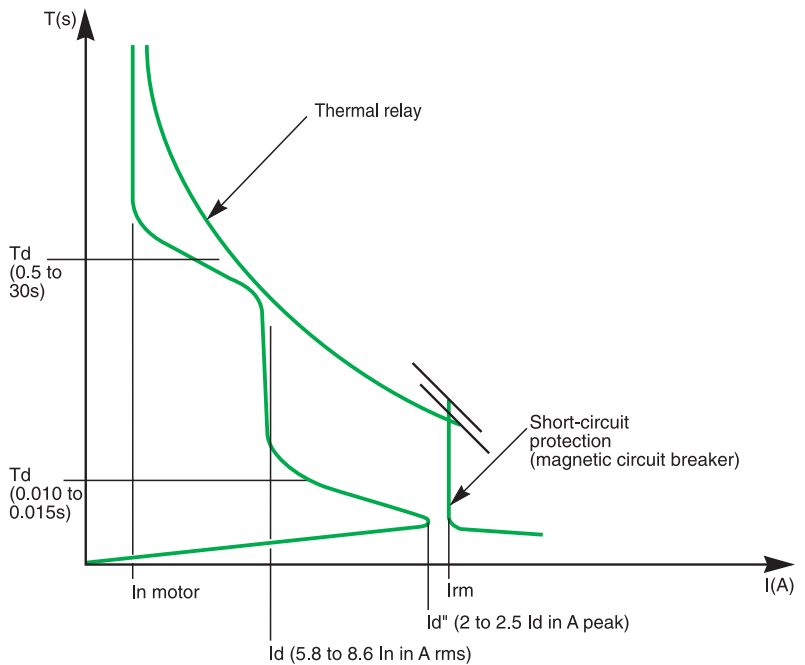

#### Typical upper and lower limits for these subtransient currents:

These values, not covered by standards, also depend on the type of motor technology used:

- ordinary motors  $I_d'' = 2 I_d$  to  $2.1 I_d$  (in A peak)
- high-efficiency motors  $I_d'' = 2.2 I_d$  to  $2.5 I_d$  (in A peak).
- variation of  $I_d''$  as a function of  $I_d$ :

Type of motor	$d$ (in A rms)	$I_d''$ (in A peak)
Ordinary motor	5.8 to 8.6 $I_n$ motor	$I_d'' = 2 I_d = 11.5 I_n$ (A peak) to $I_d'' = 2.1 I_d = 18 I_n$ (A peak)
High-efficiency motor	5.8 to 8.6 $I_n$ motor	$I_d'' = 2.2 I_d = 12.5 I_n$ (A peak) to $I_d'' = 2.5 I_d = 21.5 I_n$ (A peak)

**Example:** Upon energisation, a high-efficiency motor with an  $I_d$  of 7.5  $I_n$  produces a subtransient current with a value between (depending on its characteristics):

- minimum = 16.5  $I_n$  (in A peak)
- maximum = 18.8  $I_n$  (in A peak).

# Protection of motor circuits

## Using the circuit breaker/contactors coordination tables

### Subtransient currents and protection settings:

- as illustrated in the above table, subtransient currents can be very high.
- If they approach their upper limits, they can trip short-circuit protection devices (nuisance tripping)
- circuit breakers are rated to provide optimum short-circuit protection for motor starters (type 2 coordination with thermal relay and contactor)
- combinations made up of circuit breakers and contactors and thermal relays are designed to allow starting of motors generating high subtransient currents (up to 19  $I_n$  motor peak)
- the tripping of short-circuit protective devices when starting with a combination listed in the coordination tables means:
  - the limits of certain devices may be reached
  - the use of the starter under type 2 coordination conditions on the given motor may lead to premature wear of one of the components of the combination.

**In event of such a problem, the ratings of the starter and the associated protective devices must be redesigned.**

### Using the coordination tables for circuit breaker and contactors:

#### ■ ordinary motor:

The starter components can be selected directly from the coordination tables, whatever the values of the starting current ( $I_d$  from 5.8 to 8.6  $I_n$ ) and the subtransient current

#### ■ high-efficiency motors with $I_d \leq 7.5 I_n$ :

The starter components can be selected directly from the coordination tables, whatever the values of the starting current and the subtransient current

#### ■ high-efficiency motors with $I_d > 7.5 I_n$ :

When circuit breakers are used for motor currents in the neighbourhood of their rated current, they are set to provide minimum short-circuit protection at **19  $I_n$  motor (A peak)**.

There are two possibilities:

- the subtransient starting current is known (indicated by the motor manufacturer) and is less than **19  $I_n$  motor (A peak)**.

In this case, the starter components can be selected directly from the coordination tables, whatever the value of the starting current (for  $I_d > 7.5 I_n$ ).

Example: for a 110 kW 380/415 V 3-phase motor, the selected components are: NSX250-MA220/LC1-F225/LR9-F5371.

- the subtransient starting current is unknown or greater than 19  $I_n$  motor (A peak).

In this case, the value used for the motor power in the coordination tables should be increased by 20 % to satisfy optimum starting and coordination conditions.

Example: for a 110 kW 380/415 V 3-phase motor, the selected components are those for a motor power of  $110 + 20 \% = 132$  kW: NSX400 Micrologic 4.3M/LC1-F265/LR9-F5371

### Reversing starters and coordination

The starter components can be selected using the tables for direct-on-line starting. Replace contactors LC1 by LC2.

### Star-delta starting and coordination

- the components should be sized according to the current flowing in the motor windings
- the mounting locations and connections of the various components of star-delta starters should be selected according to the type of coordination required and the protective devices implemented.

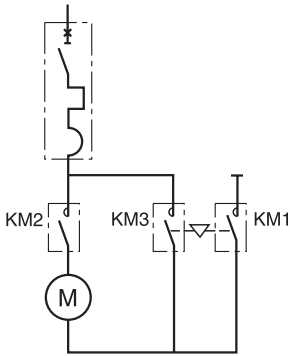

Solution with thermal-magnetic motor circuit breaker.

### Star-delta starting and type 1 coordination

Contactors KM2 and KM3 are sized for the line current divided by 3, however, for the sake of homogeneity, it is often identical to contactors KM2 and KM3.

The starter components are selected from the special star-delta type 1 coordination tables.

**Example:** consider the following case:

- 45 kW motor supplied at 380 V
- star-delta starting
- separate thermal relay
- short-circuit current of 20 kA at the starter
- type 1 coordination.

The starter components are selected using the table on page 170 :

- circuit breaker: NSX100N-MA 100
- contactor: LC3-D50
- thermal relay: LR2-D3357.

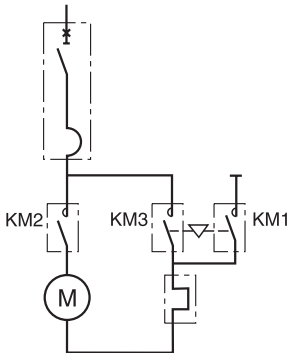

Solution with magnetic motor circuit breaker.

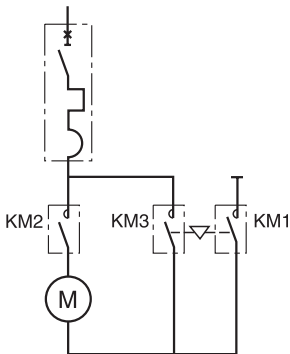

Solution with thermal-magnetic motor circuit breaker.

### Star-delta starting and type 2 coordination

Contactors KM1, KM2 and KM3 are sized for the line current.

The starter components are selected from the direct-on-line type 2 coordination tables.

**Example:** consider the following case:

- 55 kW motor supplied at 415 V
- star-delta starting
- thermal protection built into the circuit breaker providing short-circuit protection
- short-circuit current of 45 kA at the starter
- type 2 coordination.

The starter components are selected using the table on page 170:

- circuit breaker: NSX160H with Micrologic 6.2
- starter: LC1-F115 to be replaced by LC3-F115.

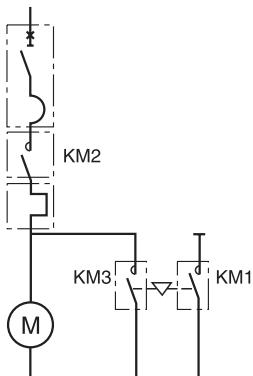

Solution with magnetic motor circuit breaker.

### Starting class and thermal relays

The following tables correspond to "normal" motor starting times. The associated thermal relays are either class 10 or 10 A (tripping time < 10 s).

- for motors with long starting times, the class 10 or 10 A thermal relays must be replaced with class 20 thermal relays as indicated in the correspondence table opposite (for type 1 and type 2 coordination)
- long starting times requiring a class 30 relay:
  - apply a derating coefficient (K = 0.8) to the circuit breaker and the contactor
- coordination tables with the multifunction protective relay LT6-P
  - three types of multifunction relays (see the corresponding catalogue for detailed characteristics) are available. They may be connected:
    - directly to the motor power supply line
    - to the secondary winding of the current transformer.

The characteristics of the current transformers are the following (as defined by IEC 44-1/44-3):

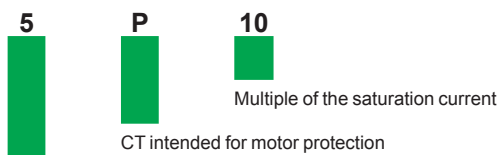

Accuracy class (5 %)

The current transformer ratings must be 5 VA per phase.

Relay	Rating	Direct	Connecting Using current trans.
LTM R08	0.4 to 8 A	■	■
LTM R27	1.35 to 27 A	■	
LTM R100	5 to 100 A	■	

### Correspondence table class 10 A and class 20 relay

Contactor series D	Thermal relay Class 10/10 A	Class 20	Setting range
LC1-D09-D38	LRD-05		0.63...1
	LRD-06		1...1.6
	LRD-07		1.6...2.5
	LRD-08	LRD-1508	2.5...4
	LRD-10	LRD-1510	4...6
	LRD-12	LRD-1512	5.5...8
	LRD-14	LRD-1514	7...10
LC1-D12-D38	LRD-16	LRD-1516	9...13
LC1-D18-D38	LRD-21	LRD-1521	12...18
LC1-D25-D38	LRD-22	LRD-1522	17...25
	LRD-32	LRD-1532	23...32
LC1-D32-D38	LRD-35		30...38
D40-D95	LRD-3308	LRD-1508 <sup>(1)</sup>	2.5...4
	LRD-3310	LRD-1510 <sup>(1)</sup>	4...6
	LRD-3312	LRD-1512 <sup>(1)</sup>	5.5...8
	LRD-3314	LRD-1514 <sup>(1)</sup>	7...10
	LRD-3316	LRD-1516 <sup>(1)</sup>	9...13
	LRD-3321	LRD-1521 <sup>(1)</sup>	12...18
	LRD-3322	LR2-D35 22	17...25
	LRD-3353	LR2-D35 53	23...32
	LRD-3355	LR2-D35 55	30...40
	LRD-3357	LR2-D35 57	37...50
	D50-D95	LRD-3359	LR2-D35 59
LRD-3361		LR2-D35 61	55...70
D65-D95	LRD-3363	LR2-D35 63	63...80
D40A-D65A	LRD-313	LRD-313L	9...13
	LRD-318	LRD-318L	12...18
	LRD-325	LRD-325L	17...25
	LRD-332	LRD-332L	23...32
	LRD-340	LRD-340L	30...40
	LRD-350	LRD-350L	37...50
	LRD-365	LRD-365L	38...65
	LRD-3365		80...104
D80-D95	LR9-D53 57	LR9-D55 57	30...50
	LR9-D53 63	LR9-D55 63	48...80
	LR9-D53 67	LR9-D55 67	60...100
	LR9-D53 69	LR9-D55 69	90...150
	LR9-F53 57	LR9-F55 57	30...50
F115-F185	LR9-F53 63	LR9-F55 63	48...80
	LR9-F53 67	LR9-F55 67	60...100
	LR9-F53 69	LR9-F55 69	90...150
	LR9-F53 71	LR9-F55 71	132...220
F185-F400	LR9-F73 75	LR9-F75 75	200...330
F225-F500	LR9-F73 79	LR9-F75 79	300...500
F400-F800	LR9-F73 81	LR9-F75 81	380...630

<sup>(1)</sup> Independant mounting with LAD 7B105.

# Type 2 coordination (IEC 60947-4-1) 220/240 V

DB110219.eps

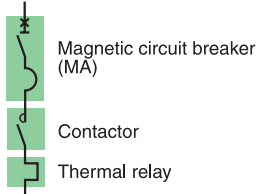

## Circuit breakers, contactors and thermal relays

Performance: Ue = 220/240 V

Circuit breakers	N	H	L
NS80-MA	-	100 kA	-

Starting<sup>(1)</sup>: normal, LRD2 class 10 A, LR9 class 10.

Motors P (kW)				Circuit breakers			Contactors <sup>(2)</sup>		Thermal o/l relays	
	I (A) 220 V	I (A) 240 V	Ie max (A)	Type	Rating (A)	Irm (A)	Type	Type	I <sub>rth</sub> (A) <sup>(1)</sup>	
0.09	0.7	0.6	1	NS80H-MA	1.5	13.5	LC1 D09	LRD 05	0.63/1	
0.12	0.9	0.8	1	NS80H-MA	1.5	13.5	LC1 D09	LRD 05	0.63/1	
0.18	1.2	1.1	1.6	NS80H-MA	2.5	22.5	LC1 D09	LRD 06	1/1.6	
0.25	1.5	1.4	2.5	NS80H-MA	2.5	32.5	LC1 D09	LRD 07	1.6/2.5	
0.37	2	1.8	2.5	NS80H-MA	2.5	32.5	LC1 D09	LRD 07	1.6/2.5	
0.55	2.8	2.6	4	NS80H-MA	6.3	57	LC1 D32	LRD 08	2.5/4	
0.75	3.5	3.2	4	NS80H-MA	6.3	57	LC1 D32	LRD 08	2.5/4	
1.1	5	4.5	6	NS80H-MA	6.3	82	LC1 D32	LRD 10	4/6	
1.5	6.5	6	8	NS80H-MA	12.5	113	LC1 D40	LRD 33 12	5.5/8	
2.2	9	8	10	NS80H-MA	12.5	138	LC1 D40	LRD 33 14	7/10	
3	12	11	12.5	NS80H-MA	12.5	163	LC1 D40	LRD 33 16	9/13	
4	15	14	18	NS80H-MA	25	250	LC1 D40	LRD 33 21	12/18	
5.5	21	19	25	NS80H-MA	25	325	LC1 D40	LRD 33 22	17/25	
6.3	24	22	25	NS80H-MA	25	325	LC1 D40	LRD 33 22	17/25	
7.5	28	25	32	NS80H-MA	50	450	LC1 D40	LRD 33 53	23/32	
10	36	33	40	NS80H-MA	50	550	LC1 D50	LRD 33 55	30/40	
11	39	36	50	NS80H-MA	50	650	LC1 D50	LRD 33 57	37/50	
15	52	48	65	NS80H-MA	80	880	LC1 D65	LRD 33 59	48/65	
18.5	63	59	65	NS80H-MA	80	880	LC1 D65	LRD 33 59	48/65	
22	75	70	80	NS80H-MA	80	1040	LC1 D80	LRD 33 63	63/80	

<sup>(1)</sup> For long starting (class 20), see the correspondence table for thermal relay.

<sup>(2)</sup> Reversers: replace LC1 with LC2; start-delta starter: replace LC1 with LC3.

DS110210.eps

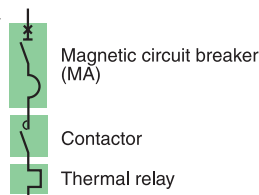

## Circuit breakers, contactors and thermal relays

Performance: Ue = 220/240 V

Circuit breakers	B	F	N	H	S	L
NSX100/160/250-MA	40 kA	85 kA	90 kA	100 kA	120 kA	150 kA
NSX400/630 Micrologic 1.3 M	40 kA	85 kA	90 kA	100 kA	120 kA	150 kA
NS800L/NS1000L Micrologic 5.0	-	-	-	-	-	150 kA

Starting<sup>(1)</sup>: normal, LRD class 10 A, LR9 class 10.

Motors P (kW)	I (A) 220 V	I (A) 240 V	Ie max (A)	Circuit breakers			Contactors <sup>(2)</sup> Type	Thermal o/l relays	
				Type	Rating (A)	I <sub>rm</sub> (A)		Type	I <sub>rth</sub> (A) <sup>(1)</sup>
0.18	1.2	1.1	1.6	NSX100-MA	2.5	22.5	LC1 D09	LRD 06	1/1.6
0.25	1.5	1.4	2.5	NSX100-MA	2.5	32.5	LC1 D09	LRD 07	1.6/2.5
0.37	2	1.8	2.5	NSX100-MA	2.5	32.5	LC1 D09	LRD 07	1.6/2.5
0.55	2.8	2.6	4	NSX100-MA	6.3	57	LC1 D32	LRD 08	2.5/4
0.75	3.5	3.2	4	NSX100-MA	6.3	57	LC1 D32	LRD 08	2.5/4
1.1	5	4.5	6	NSX100-MA	6.3	82	LC1 D32	LRD 10	4/6
1.5	6.5	6	8	NSX100-MA	12.5	113	LC1 D80	LRD 33 12	5.5/8
2.2	9	8	10	NSX100-MA	12.5	138	LC1 D80	LRD 33 14	7/10
3	12	11	12.5	NSX100-MA	12.5	163	LC1 D80	LRD 33 16	9/13
4	15	14	18	NSX100-MA	25	250	LC1 D80	LRD 33 21	12/18
5.5	21	19	25	NSX100-MA	25	325	LC1 D80	LRD 33 22	17/25
6.3	24	22	25	NSX100-MA	25	325	LC1 D80	LRD 33 22	17/25
7.5	28	25	32	NSX100-MA	50	450	LC1 D80	LRD 33 53	23/32
10	36	33	40	NSX100-MA	50	550	LC1 D80	LRD 33 55	30/40
11	39	36	40	NSX100-MA	50	550	LC1 D80	LRD 33 55	30/40
15	52	48	63	NSX100-MA	100	700	LC1 D80	LRD 33 59	48/65
18.5	63	59	63	NSX100-MA	100	900	LC1 D80	LRD 33 59	48/65
22	75	70	80	NSX100-MA	100	1100	LC1 D80	LRD 33 63	63/80
30	100	95	100	NSX100-MA	100	1300	LC1 D115	LR9 D53 67	60/100
							LC1 F115	LR9 F53 67	
37	125	115	150	NSX160-MA	150	1950	LC1 D150	LR9 D53 69	90/150
							LC1 F150	LR9 F53 69	
45	150	140	150	NSX160-MA	150	1950	LC1 D150	LR9 D53 69	90/150
							LC1 F150	LR9 F53 69	
55	180	170	185	NSX250-MA	220	2420	LC1 F185	LR9 F53 71	132/220
			220	NSX400 - Micrologic 1.3 M	320	2880	LC1 F265		
75	250	235	265	NSX400 - Micrologic 1.3 M	320	3500	LC1 F265	LR9 F73 75	200/330
90	300	270	320	NSX400 - Micrologic 1.3 M	320	4160	LC1 F330	LR9 F73 75	200/330
110	360	330	400	NSX630 - Micrologic 1.3 M	500	5700	LC1 F400	LR9 F73 79	300/500
132	430	400	500	NSX630 - Micrologic 1.3 M	500	6500	LC1 F500	LR9 F73 79	300/500
150	460	450	500	NSX630 - Micrologic 1.3 M	500	6500	LC1 F500	LR9 F73 79	300/500
160	520	480	630	NS800L - Micrologic 5.0 - LR off	800	8000	LC1 F630	LR9 F73 81	380/630
200	630	580	630	NS800L - Micrologic 5.0 - LR off	800	8000	LC1 F630	LR9 F73 81	380/630
220	700	640	700	NS800L - Micrologic 5.0 - LR off	800	9600	LC1 F780	TC800/5 + LRD 10	630/1000
250	800	730	800	NS1000L - Micrologic 5.0 - LR off	1000	10000	LC1 F780	TC800/5 + LRD 10	630/1000

(1) For long starting (class 20), see the correspondence table for thermal relay.

(2) Reversers: replace LC1 with LC2; start-delta starter: replace LC1 with LC3.

# Type 2 coordination (IEC 60947-4-1) 220/240 V

DE1110216 eps

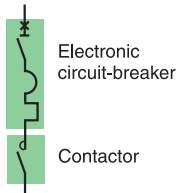

## Circuit breakers, contactors

### Performance: Ue = 220/240 V

Circuit breakers	B	F	N	H	S	L
NSX100/160/250 Micrologic 2.2 M/6.2 M	40 kA	85 kA	90 kA	100 kA	120 kA	150 kA
NSX400/630 Micrologic 2.3 M/6.3 M	40 kA	85 kA	90 kA	100 kA	120 kA	150 kA
NS800L/NS1000L Micrologic 5.0	-	-	-	-	-	150 kA

Starting	Standard IEC 60947-4-1		
Micrologic	2.2 M/2.3 M	6.2 M/6.3 M	5.0
Normal (class)	5, 10	5, 10	10
Long (class)	20	20, 30 <sup>(1)</sup>	20

Motors P (kW)	I (A) 220 V	I (A) 240 V	Ie max (A)	Circuit breakers				Contactors <sup>(2)</sup>
				Type	Trip unit	I <sub>rth</sub> (A)	I <sub>rm</sub> (A) <sup>(3)</sup>	Type
3	12	11	25	NSX100	Micrologic 2.2 or 6.2	12/25	13 I <sub>rth</sub>	LC1 D80
4	15	14	25	NSX100	Micrologic 2.2 or 6.2	12/25	13 I <sub>rth</sub>	LC1 D80
5.5	21	19	25	NSX100	Micrologic 2.2 or 6.2	12/25	13 I <sub>rth</sub>	LC1 D80
6.3	24	22	25	NSX100	Micrologic 2.2 or 6.2	12/25	13 I <sub>rth</sub>	LC1 D80
7.5	28	25	50	NSX100	Micrologic 2.2 or 6.2	25/50	13 I <sub>rth</sub>	LC1 D80
10	36	33	50	NSX100	Micrologic 2.2 or 6.2	25/50	13 I <sub>rth</sub>	LC1 D80
11	39	36	50	NSX100	Micrologic 2.2 or 6.2	25/50	13 I <sub>rth</sub>	LC1 D80
15	52	48	80	NSX100	Micrologic 2.2 or 6.2	50/100	13 I <sub>rth</sub>	LC1 D80
18.5	63	59	80	NSX100	Micrologic 2.2 or 6.2	50/100	13 I <sub>rth</sub>	LC1 D80
22	75	70	100	NSX100	Micrologic 2.2 or 6.2	50/100	13 I <sub>rth</sub>	LC1 D115 or LC1 F115
30	100	95	100	NSX100	Micrologic 2.2 or 6.2	50/100	13 I <sub>rth</sub>	LC1 D115 or LC1 F115
37	125	115	150	NSX160	Micrologic 2.2 or 6.2	70/150	13 I <sub>rth</sub>	LC1 D150 or LC1 F150
45	150	140	150	NSX160	Micrologic 2.2 or 6.2	70/150	13 I <sub>rth</sub>	LC1 D150 or LC1 F150
55	180	170	185	NSX250	Micrologic 2.2 or 6.2	100/220	13 I <sub>rth</sub>	LC1 F185
				NSX400	Micrologic 2.3 or 6.3	160/320	13 I <sub>rth</sub>	LC1 F185
75	250	235	265	NSX400	Micrologic 2.3 or 6.3	160/320	13 I <sub>rth</sub>	LC1 F265
90	300	280	320	NSX400	Micrologic 2.3 or 6.3	160/320	13 I <sub>rth</sub>	LC1 F330
110	360	330	400	NSX630	Micrologic 2.3 or 6.3	250/500	13 I <sub>rth</sub>	LC1 F400
132	430	400	500	NSX630	Micrologic 2.3 or 6.3	250/500	13 I <sub>rth</sub>	LC1 F500
150	460	420	500	NSX630	Micrologic 2.3 or 6.3	250/500	13 I <sub>rth</sub>	LC1 F500
160	520	480	630	NS800L	Micrologic 5.0	320/800	8000	LC1 F630
200	630	580	630	NS800L	Micrologic 5.0	320/800	8000	LC1 F630
220	700	640	700	NS800L	Micrologic 5.0	320/800	9600	LC1 F780
250	800	730	800	NS1000L	Micrologic 5.0	400/1000	10000	LC1 F780

(1) For class 30 the contactor rating shall be checked according to 30 s thermal withstand (F range).

(2) Reversers: replace LC1 with LC2; start-delta starter: replace LC1 with LC3.

(3) Ii for Micrologic 5.0 control unit.

# Type 2 coordination (IEC 60947-4-1) 380/400/415 V

DE110219.eps

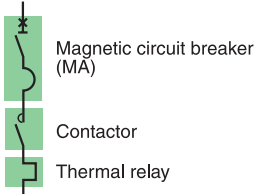

## Circuit breakers, contactors and thermal relays

Performance: Ue = 380/400/ 415 V

Circuit breakers	H
NS80-MA	70 kA

Starting<sup>(1)</sup>: normal, LRD class 10 A, LR9 class 10.

Motors P (kW)					Circuit breakers			Contactors <sup>(2)</sup>		Thermal o/l relays	
	I (A) 380 V	I (A) 400 V	I (A) 415 V	Ie max (A)	Type	Rating (A)	I <sub>rm</sub> (A)	Type	Type	I <sub>rth</sub> <sup>(1)</sup>	
0.18	0.7	0.6	0.6	1	NS80H-MA	1.5	13.5	LC1 D09	LRD 05	0.63/1	
0.25	0.9	0.8	0.8	1	NS80H-MA	1.5	13.5	LC1 D09	LRD 05	0.63/1	
0.37	1.2	1.1	1.1	1.6	NS80H-MA	2.5	22.5	LC1 D09	LRD 06	1/1.6	
0.55	1.6	1.5	1.5	2.5	NS80H-MA	2.5	32.5	LC1 D09	LRD 07	1.6/2.5	
0.75	2	1.9	1.8	2.5	NS80H-MA	2.5	32.5	LC1 D09	LRD 07	1.6/2.5	
1.1	2.8	2.7	2.6	4	NS80H-MA	6.3	57	LC1 D32	LRD 08	2.5/4	
1.5	3.7	3.6	3.4	4	NS80H-MA	6.3	57	LC1 D32	LRD 08	2.5/4	
2.2	5.3	4.9	4.8	6	NS80H-MA	6.3	82	LC1 D32	LRD 10	4/6	
3	7	6.5	6.2	8	NS80H-MA	12.5	113	LC1 D40	LRD 33 12	5.5/8	
4	9	8.5	8.2	10	NS80H-MA	12.5	138	LC1 D40	LRD 33 14	7/10	
5.5	12	11.5	11	12.5	NS80H-MA	12.5	163	LC1 D40	LRD 33 16	9/13	
7.5	16	15.5	14	16	NS80H-MA	25	250	LC1 D40	LRD 33 21	12/18	
10	21	20	19	25	NS80H-MA	25	325	LC1 D40	LRD 33 22	17/25	
11	23	22	21	25	NS80H-MA	25	325	LC1 D40	LRD 33 22	17/25	
15	30	29	28	32	NS80H-MA	50	450	LC1 D40	LRD 33 53	23/32	
18.5	37	35	34	40	NS80H-MA	50	550	LC1 D50	LRD 33 55	30/40	
22	43	41	40	50	NS80H-MA	50	650	LC1 D50	LRD 33 57	37/50	
30	59	55	53	63	NS80H-MA	80	880	LC1 D65	LRD 33 59	48/65	
37	72	70	66	80	NS80H-MA	80	1040	LC1 D80	LRD 33 63	63/80	

(1) Heavy starting (class 20), see thermal o/l chart of equivalence.

(2) Reversers: replace LC1 with LC2; start-delta starter: replace LC1 with LC3.

# Type 2 coordination (IEC 60947-4-1) 380/400/415 V

DE1112219.eps

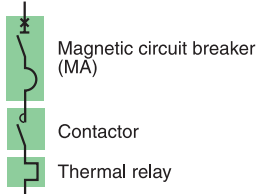

## Circuit breakers, contactors and thermal relays

**Performance: Ue = 380/400/415 V**

Circuit breakers	H
NS80-MA	70 kA

**Starting<sup>(1)</sup>:** adjustable class 10 A to 30.

Motors P (kW)					Circuit breakers			Contactors <sup>(2)</sup> Irm (A)	Thermal o/l relays	
	I (A) 380 V	I (A) 400 V	I (A) 415 V	Ie max (A)	Type	Trip unit	I <sub>rth</sub> (A)		Type	I <sub>rth</sub> <sup>(1)</sup>
0.18	0.7	0.6	0.6	1	NS80H-MA	1.5	13.5	LC1 D40	LTM R08	0.4/8
0.25	0.9	0.8	0.8	1	NS80H-MA	1.5	13.5	LC1 D40	LTM R08	0.4/8
0.37	1.2	1.1	1.1	2.5	NS80H-MA	2.5	32.5	LC1 D40	LTM R08	0.4/8
0.55	1.6	1.5	1.5	2.5	NS80H-MA	2.5	32.5	LC1 D40	LTM R08	0.4/8
0.75	2	1.9	1.8	2.5	NS80H-MA	2.5	32.5	LC1 D40	LTM R08	0.4/8
1.1	2.8	2.7	2.6	5	NS80H-MA	6.3	70	LC1 D40	LTM R08	0.4/8
1.5	3.7	3.6	3.4	5	NS80H-MA	6.3	70	LC1 D40	LTM R08	0.4/8
2.2	5.3	4.9	4.8	6.3	NS80H-MA	6.3	82	LC1 D40	LTM R08	0.4/8
3	7	6.5	6.2	12.5	NS80H-MA	12.5	163	LC1 D40	LTM R27	1.35/27
4	9	8.5	8.2	12.5	NS80H-MA	12.5	163	LC1 D40	LTM R27	1.35/27
5.5	12	11.5	11	12.5	NS80H-MA	12.5	163	LC1 D40	LTM R27	1.35/27
7.5	16	15.5	14	25	NS80H-MA	25	325	LC1 D40	LTM R27	1.35/27
10	21	20	19	25	NS80H-MA	25	325	LC1 D40	LTM R27	1.35/27
11	23	22	21	25	NS80H-MA	25	325	LC1 D40	LTM R27	1.35/27
15	30	29	28	50	NS80H-MA	50	650	LC1 D80	LTM R100	5/100
18.5	37	35	34	50	NS80H-MA	50	650	LC1 D80	LTM R100	5/100
22	43	41	40	50	NS80H-MA	50	650	LC1 D80	LTM R100	5/100
30	59	55	53	80	NS80H-MA	80	1040	LC1 D80	LTM R100	5/100
37	72	70	66	80	NS80H-MA	80	1040	LC1 D80	LTM R100	5/100

**(1)** For installations with a class 30 relay, a derating of 20 % must be apply on circuit breakers.

**(2)** Reversers: replace LC1 with LC2; start-delta starter: replace LC1 with LC3.

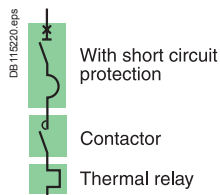

## Circuit breakers, contactors and thermal relays

### Performance "iq": Ue = 380/400 V

Circuit breakers	B	F	N	H	S	L
NSX100/160/250-MA	25 kA	36 kA	50 kA	70 kA	100 kA	130 kA
NSX400/630 Micrologic 1.3 M	25 kA	36 kA	50 kA	70 kA	100 kA	130 kA
NS800L/NS1000L Micrologic 5.0	-	-	-	-	-	130 kA

Starting<sup>(1)</sup>: normal, LRD class 10 A, LR9 class 10.

Motors P (kW)				Circuit breakers			Contactors <sup>(2)</sup>		Thermal o/l relays	
	I (A) 380 V	I (A) 400 V	Ie max (A)	Type	Rating (A)	Irm (A) <sup>(3)</sup>	Type	Type	Irth <sup>(4)</sup>	
0.37	1.2	1.1	1.6	NSX100-MA	2.5	22.5	LC1 D09	LRD 06 <sup>(4)</sup>	1/1.6	
0.55	1.6	1.5	2.5	NSX100-MA	2.5	32.5	LC1 D09	LRD 07 <sup>(4)</sup>	1.6/2.5	
0.75	2	1.9	2.5	NSX100-MA	2.5	32.5	LC1 D09	LRD 07 <sup>(4)</sup>	1.6/2.5	
1.1	2.8	2.7	4	NSX100-MA	6.3	57	LC1 D32	LRD 08 <sup>(5)</sup>	2.5/4	
1.5	3.7	3.6	4	NSX100-MA	6.3	57	LC1 D32	LRD 08 <sup>(5)</sup>	2.5/4	
2.2	5.3	4.9	6	NSX100-MA	6.3	82	LC1 D32	LRD 10 <sup>(5)</sup>	4/6	
3	7	6.5	8	NSX100-MA	12.5	113	LC1 D80	LRD 3312 <sup>(5)</sup>	5.5/8	
4	9	8.5	10	NSX100-MA	12.5	138	LC1 D80	LRD 3314 <sup>(5)</sup>	7/10	
5.5	12	11.5	12.5	NSX100-MA	12.5	163	LC1 D80	LRD 3316 <sup>(5)</sup>	9/13	
7.5	16	15.5	18	NSX100-MA	25	250	LC1 D80	LRD 3321	12/18	
10	21	20	25	NSX100-MA	25	325	LC1 D80	LRD 3322	17/25	
11	23	22	25	NSX100-MA	25	325	LC1 D80	LRD 3322	17/25	
15	30	29	32	NSX100-MA	50	450	LC1 D80	LRD 33 53	23/32	
18.5	37	35	40	NSX100-MA	50	550	LC1 D80	LRD 33 55	30/40	
22	43	41	50	NSX100-MA	50	650	LC1 D80	LRD 33 57	37/50	
30	59	55	63	NSX100-MA	100	900	LC1 D80	LRD 33 59	48/65	
37	70	66	80	NSX100-MA	100	1100	LC1 D80	LRD 33 63	63/80	
45	85	80	100	NSX100-MA	100	1300	LC1 D115	LR9 D53 67	60/100	
							LC1 F115	LR9 F53 67		
55	105	97	115	NSX160-MA	150	1500	LC1 D115	LR9 D53 69	90/150	
							LC1 F115	LR9 F53 69		
75	140	132	150	NSX160-MA	150	1950	LC1 D150	LR9 D53 69	90/150	
							LC1 F150	LR9 F53 69		
90	170	160	185	NSX250-MA	220	2420	LC1 F185	LR9 F53 71	132/220	
110	205	195	220	NSX250-MA	220	2860	LC1 F225	LR9 F53 71	132/220	
			265	NSX400 - Micrologic 1.3 M	320	3500	LC1 F265	LR9 F73 75	200/330	
132	250	230	265	NSX400 - Micrologic 1.3 M	320	3500	LC1 F265	LR9 F73 75	200/330	
160	300	280	320	NSX400 - Micrologic 1.3 M	320	4160	LC1 F330	LR9 F73 75	200/330	
200	370	350	400	NSX630 - Micrologic 1.3 M	500	5700	LC1 F400 (70 kA)	LR9 F73 79	300/500	
							LC1 F500 (130 kA)			
220	408	380	500	NSX630 - Micrologic 1.3 M	500	6500	LC1 F500	LR9 F73 79	300/500	
250	460	430	500	NSX630 - Micrologic 1.3 M	500	6500	LC1 F500	LR9 F73 79	300/500	
300	565	500	630	NS800L - Micrologic 5.0 - LR off	800	8000	LC1 F630	LR9 F73 81	380/630	
335	620	560	630	NS800L - Micrologic 5.0 - LR off	800	8000	LC1 F630	LR9 F73 81	380/630	
375	670	620	780	NS1000L - Micrologic 5.0 - LR off	1000	10000	LC1 F780	TC800/1 + LRD 05	500/800	
400	710	690	780	NS1000L - Micrologic 5.0 - LR off	1000	10000	LC1 F780	TC800/1 + LRD 05	500/800	
450	800	750	780	NS1000L - Micrologic 5.0 - LR off	1000	10000	LC1 F780	TC800/1 + LRD 05	500/800	

(1) Heavy starting (class 20), see thermal o/l chart of equivalence.

(2) Reversers: replace LC1 with LC2; start-delta starter: replace LC1 with LC3.

(3) Ii for Micrologic 5.0 control unit.

(4) Iq ≤ 50 kA.

(5) Type 1 for thermal relay.

# Type 2 coordination (IEC 60947-4-1) 380/400 V

DE1112216.eps

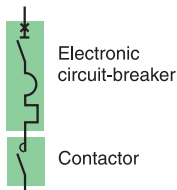

## Circuit breakers, contactors

### Performance: Ue = 380/400 V

Circuit breakers	B	F	N	H	S	L
NSX100/160/250 Micrologic 2.2 M/6.2 M	25 kA	36 kA	50 kA	70 kA	100 kA	130 kA
NSX400/630 Micrologic 2.3 M/6.3 M	25 kA	36 kA	50 kA	70 kA	100 kA	130 kA
NS800L/NS1000L Micrologic 5.0	-	-	-	-	-	130 kA

Starting	Standard IEC 60947-4-1		
Micrologic	2.2 M/2.3 M	6.2 M/6.3 M	5.0
Normal (class)	5, 10	5, 10	10
Long (class)	20	20, 30 <sup>(1)</sup>	20

Motors P (kW)	I (A) 380 V	I (A) 400 V	Ie max	Circuit breakers			Contactors <sup>(2)</sup>	
				Type	Trip unit	I <sub>rt</sub> h (A)	I <sub>rm</sub> (A) <sup>(3)</sup>	Type
7.5	16	15.5	25	NSX100	Micrologic 2.2 M or 6.2 M	12/25	13 I <sub>rt</sub> h	LC1 D80
10	21	20	25	NSX100	Micrologic 2.2 M or 6.2 M	12/25	13 I <sub>rt</sub> h	LC1 D80
11	23	22	25	NSX100	Micrologic 2.2 M or 6.2 M	12/25	13 I <sub>rt</sub> h	LC1 D80
15	30	29	50	NSX100	Micrologic 2.2 M or 6.2 M	25/50	13 I <sub>rt</sub> h	LC1 D80
18.5	37	35	50	NSX100	Micrologic 2.2 M or 6.2 M	25/50	13 I <sub>rt</sub> h	LC1 D80
22	44	41	50	NSX100	Micrologic 2.2 M or 6.2 M	25/50	13 I <sub>rt</sub> h	LC1 D80
30	60	55	80	NSX100	Micrologic 2.2 M or 6.2 M	50/100 (80)	13 I <sub>rt</sub> h	LC1 D80
37	72	66	80	NSX100	Micrologic 2.2 M or 6.2 M	50/100 (80)	13 I <sub>rt</sub> h	LC1 D80
45	85	80	100	NSX100	Micrologic 2.2 M	50/100	13 I <sub>rt</sub> h	LC1 D115 or LC1 F115
55	105	97	115	NSX160	Micrologic 2.2 M or 6.2 M	70/150	13 I <sub>rt</sub> h	LC1 D115 or LC1 F115
75	138	132	150	NSX160	Micrologic 2.2 M or 6.2 M	70/150	13 I <sub>rt</sub> h	LC1 D150 or LC1 F150
90	170	160	185	NSX250	Micrologic 2.2 M or 6.2 M	100/220	13 I <sub>rt</sub> h	LC1 F185
110	205	195	220	NSX250	Micrologic 2.2 M or 6.2 M	100/220	13 I <sub>rt</sub> h	LC1 F225
			265	NSX400	Micrologic 2.3 M or 6.3 M	160/320	13 I <sub>rt</sub> h	LC1 F265
132	250	230	265	NSX400	Micrologic 2.3 M or 6.3 M	160/320	13 I <sub>rt</sub> h	LC1 F265
160	300	280	320	NSX400	Micrologic 2.3 M or 6.3 M	160/320	13 I <sub>rt</sub> h	LC1 F330
200	370	350	400/500	NSX630	Micrologic 2.3 M or 6.3 M	250/500	13 I <sub>rt</sub> h	LC1 F400 (70 kA) LC1 F500 (130 kA)
220	408	380	500	NSX630	Micrologic 2.3 M or 6.3 M	250/500	13 I <sub>rt</sub> h	LC1 F500
250	460	430	500	NSX630	Micrologic 2.3 M or 6.3 M	250/500	13 I <sub>rt</sub> h	LC1 F500
			630	NS800L	Micrologic 5.0	320/800	8000	LC1 F630
300	565	500	630	NS800L	Micrologic 5.0	320/800	8000	LC1 F630
335	620	560	630	NS800L	Micrologic 5.0	320/800	8000	LC1 F630
375	670	620	780	NS1000L	Micrologic 5.0	400/1000	10000	LC1 F780
400	710	690	780	NS1000L	Micrologic 5.0	400/1000	10000	LC1 F780
450	800	750	780	NS1000L	Micrologic 5.0	400/1000	10000	LC1 F780

<sup>(1)</sup> For class 30 the contactor rating shall be checked according to 30 s thermal withstand (F range).

<sup>(2)</sup> Reversers: replace LC1 with LC2; start-delta starter: replace LC1 with LC3.

<sup>(3)</sup> I<sub>i</sub> for Micrologic 5.0 control unit.

DE 119497 eps



With short circuit breaker protection



Contactor



Thermal relay on CT

## Circuit breakers, contactors and thermal relays

Performance "iq": Ue = 380/400 V

Circuit breakers	B	F	N	H	S	L
NSX100/160/250-MA	25 kA	36 kA	50 kA	70 kA	100 kA	130 kA
NSX400/630-MA	25 kA	36 kA	50 kA	70 kA	100 kA	130 kA
NS800L/NS1000L Micrologic 5.0	-	-	-	-	-	130 kA

Starting<sup>(1)</sup>: adjustable class 10 A to 30.

Motors P (kW)	I (A) 380 V	I (A) 400 V	Ie max	Circuit breakers			Contactors <sup>(2)</sup>		Thermal o/l relays	
				Type	Rating (A)	I <sub>rm</sub> (A) <sup>(3)</sup>	Type	Type	I <sub>rth</sub> <sup>(1)</sup>	
0.37	1.2	1.1	2.5	NSX100-MA	2.5	32.5	LC1 D40A <sup>(4)</sup>	LTM R08	0.4/8	
0.55	1.6	1.5	2.5	NSX100-MA	2.5	32.5	LC1 D40A <sup>(4)</sup>	LTM R08	0.4/8	
0.75	2	1.9	2.5	NSX100-MA	2.5	32.5	LC1 D40A <sup>(4)</sup>	LTM R08	0.4/8	
1.1	2.8	2.7	5	NSX100-MA	6.3	70	LC1 D65A	LTM R08	0.4/8	
1.5	3.7	3.6	5	NSX100-MA	6.3	70	LC1 D65A	LTM R08	0.4/8	
2.2	5.3	4.9	6.3	NSX100-MA	6.3	82	LC1 D65A	LTM R08	0.4/8	
3	7	6.5	12.5	NSX100-MA	12.5	163	LC1 D80	LTM R27	1.35/27	
4	9	8.5	12.5	NSX100-MA	12.5	163	LC1 D80	LTM R27	1.35/27	
5.5	12	11.5	12.5	NSX100-MA	12.5	163	LC1 D80	LTM R27	1.35/27	
7.5	16	15.5	25	NSX100-MA	25	325	LC1 D80	LTM R27	1.35/27	
10	21	20	25	NSX100-MA	25	325	LC1 D80	LTM R27	1.35/27	
11	23	22	25	NSX100-MA	25	325	LC1 D80	LTM R27	1.35/27	
15	30	29	50	NSX100-MA	50	650	LC1 D80	LTM R100	5/100	
18.5	37	35	50	NSX100-MA	50	650	LC1 D80	LTM R100	5/100	
22	43	41	50	NSX100-MA	50	650	LC1 D80	LTM R100	5/100	
30	59	55	80	NSX100-MA	100	1100	LC1 D80	LTM R100	5/100	
37	72	66	80	NSX100-MA	100	1100	LC1 D80	LTM R100	5/100	
45	85	80	100	NSX100-MA	100	1300	LC1 D115	LTM R100	5/100	
							LC1 F115			
55	105	97	115	NSX160-MA	150	1500	LC1 D115	LTM R08	On CT	
							LC1 F115			
75	140	132	150	NSX160-MA	150	1950	LC1 D150	LTM R08	On CT	
							LC1 F150			
90	170	160	185	NSX250-MA	220	2420	LC1 F185	LTM R08	On CT	
110	210	195	220	NSX250-MA	220	2860	LC1 F225	LTM R08	On CT	
			265	NSX400 - Micrologic 1.3 M	320	3500	LC1 F265			
132	250	230	265	NSX400 - Micrologic 1.3 M	320	3500	LC1 F265	LTM R08	On CT	
160	300	280	320	NSX400 - Micrologic 1.3 M	320	4000	LC1 F330	LTM R08	On CT	
200	380	350	400/500	NSX630 - Micrologic 1.3 M	500	5700	LC1 F400 (70 kA)	LTM R08	On CT	
							LC1 F500 (130 kA)			
220	420	380	500	NSX630 - Micrologic 1.3 M	500	6300	LC1 F500	LTM R08	On CT	
250	460	430	500	NSX630 - Micrologic 1.3 M	500	6300	LC1 F500	LTM R08	On CT	
			630	NS800L - Micrologic 5.0 - LR off	800	8000	LC1 F630	LTM R08	On CT	
300	565	500	630	NS800L - Micrologic 5.0 - LR off	800	8000	LC1 F630	LTM R08	On CT	
335	620	560	630	NS800L - Micrologic 5.0 - LR off	800	8000	LC1 F630	LTM R08	On CT	
375	670	620	780	NS1000L - Micrologic 5.0 - LR off	1000	10000	LC1 F780	LTM R08	On CT	
400	710	690	780	NS1000L - Micrologic 5.0 - LR off	1000	10000	LC1 F780	LTM R08	On CT	
450	800	750	780	NS1000L - Micrologic 5.0 - LR off	1000	10000	LC1 F780	LTM R08	On CT	

(1) For installations with a class 30 relay, a derating of 20 % must be apply on circuit breakers and the contactor rating shall be checked according to 30 s thermal withstand (F range).

(2) Reversers: replace LC1 with LC2; start-delta starter: replace LC1 with LC3.

(3) Ii for Micrologic 5.0 control unit.

(4) Iq < 50 kA.

DE1112/16 eps

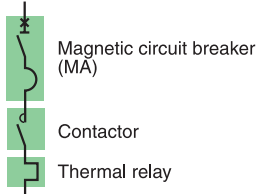

## Circuit breakers, contactors and thermal relays

### Performance: Ue = 415 V

Circuit breakers	B	F	N	H	S	L
NSX100/160/250-MA	25 kA	36 kA	50 kA	70 kA	100 kA	130 kA
NSX400/630 Micrologic 1.3 M	25 kA	36 kA	50 kA	70 kA	100 kA	130 kA
NS800L/NS1000L Micrologic 5.0	-	-	-	-	-	130 kA

Starting<sup>(1)</sup>: normal, LRD class 10 A, LR9 class 10.

Motors P (kW)	I (A) 415 V	Ie max	Circuit breakers			Contactors <sup>(2)</sup>		Thermal relays	
			Type	Rating (A)	I <sub>rm</sub> (A) <sup>(3)</sup>	Type	Type	I <sub>rth</sub> <sup>(4)</sup>	
0.37	1.1	1.6	NSX100-MA	2.5	22.5	LC1 D09	LRD 06 <sup>(4)</sup>	1/1.6	
0.55	1.5	2.5	NSX100-MA	2.5	32.5	LC1 D09	LRD 07 <sup>(4)</sup>	1.6/2.5	
0.75	1.8	2.5	NSX100-MA	2.5	32.5	LC1 D09	LRD 07 <sup>(4)</sup>	1.6/2.5	
1.1	2.6	4	NSX100-MA	6.3	57	LC1 D32	LRD 08 <sup>(5)</sup>	2.5/4	
1.5	3.4	4	NSX100-MA	6.3	57	LC1 D32	LRD 08 <sup>(5)</sup>	2.5/4	
2.2	4.8	6	NSX100-MA	6.3	82	LC1 D32	LRD 10 <sup>(5)</sup>	4/6	
3	6.2	8	NSX100-MA	12.5	113	LC1 D80	LRD 33 12 <sup>(5)</sup>	5.5/8	
4	8.2	10	NSX100-MA	12.5	138	LC1 D80	LRD 33 14 <sup>(5)</sup>	7/10	
5.5	11	12.5	NSX100-MA	12.5	163	LC1 D80	LRD 33 16 <sup>(5)</sup>	9/13	
7.5	14	18	NSX100-MA	25	250	LC1 D80	LRD 33 21	12/18	
10	19	25	NSX100-MA	25	325	LC1 D80	LRD 33 22	17/25	
11	21	25	NSX100-MA	25	325	LC1 D80	LRD 33 22	17/25	
15	28	32	NSX100-MA	50	450	LC1 D80	LRD 33 53	23/32	
18.5	34	40	NSX100-MA	50	550	LC1 D80	LRD 33 55	30/40	
22	40	40	NSX100-MA	50	650	LC1 D80	LRD 33 55	30/40	
30	53	63	NSX100-MA	100	900	LC1 D80	LRD 33 59	48/65	
37	66	80	NSX100-MA	100	1100	LC1 D80	LRD 33 63	63/80	
45	77	80	NSX100-MA	100	1100	LC1 D80	LRD 33 63	63/80	
55	94	150	NSX160-MA	150	1950	LC1 D150	LR9 D53 69	90/150	
						LC1 F150	LR9 F53 69		
75	127	150	NSX160-MA	150	1950	LC1 D150	LR9 D53 69	90/150	
						LC1 F150	LR9 F53 69		
90	154	185	NSX250-MA	220	2420	LC1 F185	LR9 F53 71	132/220	
110	188	220	NSX250-MA	220	2860	LC1 F225	LR9 F53 71	132/220	
132	230	265	NSX400 - Micrologic 1.3 M	320	3500	LC1 F265	LR9 F73 75	200/330	
160	270	320	NSX400 - Micrologic 1.3 M	320	4160	LC1 F330	LR9 F73 75	200/330	
200	340	400/500	NSX630 - Micrologic 1.3 M	500	5700	LC1 F400 (70 kA)	LR9 F73 79	300/500	
						LC1 F500 (130 kA)			
220	366	400/500	NSX630 - Micrologic 1.3 M	500	6500	LC1 F400 (70 kA)	LR9 F73 79	300/500	
						LC1 F500 (130 kA)			
250	415	500	NSX630 - Micrologic 1.3 M	500	6500	LC1 F500	LR9 F73 79	300/500	
300	500	630	NS800L - Micrologic 5.0 - LR off	800	8000	LC1 F630	LR9 F73 81	380/630	
335	560	630	NS800L - Micrologic 5.0 - LR off	800	8000	LC1 F630	LR9 F73 81	380/630	
375	620	630	NS800L - Micrologic 5.0 - LR off	800	8000	LC1 F630	LR9 F73 81	380/630	
400	660	780	NS1000L - Micrologic 5.0 - LR off	1000	9600	LC1 F780	TC800/1 + LRD 05	500/800	
450	750	780	NS1000L - Micrologic 5.0 - LR off	1000	10000	LC1 F780	TC800/1 + LRD 05	500/800	

(1) Heavy starting (class 20), see thermal o/l chart of equivalence.

(2) Reversers: replace LC1 with LC2; start-delta starter: replace LC1 with LC3.

(3) Ii for Micrologic 5.0 control unit.

(4) Iq ≤ 50 kA.

(5) Type 1 for thermal relay.

DE 119216 eps

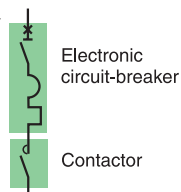

## Circuit breakers, contactors

### Performance: Ue = 415 V

Circuit breakers	B	F	N	H	S	L
NSX100/160/250 Micrologic 2.2 M/6.2 M	25 kA	36 kA	50 kA	70 kA	100 kA	130 kA
NSX400/630 Micrologic 2.3 M/6.3 M	25 kA	36 kA	50 kA	70 kA	100 kA	130 kA
NS800L/NS1000L Micrologic 5.0	-	-	-	-	-	130 kA

Starting	Standard IEC 60947-4-1		
Micrologic	2.2 M/2.3 M	6.2 M/6.3 M	5.0
Normal (class)	5, 10	5, 10	10
Long (class)	20	20, 30 <sup>(1)</sup>	20

Motors P (kW)	I (A) 415 V	Ie max	Circuit breakers				Contactors <sup>(2)</sup> Type
			Type	Trip unit	Irth (A)	Irm (A) <sup>(3)</sup>	
7.5	14	25	NSX100	Micrologic 2.2 M or 6.2 M	12/25	13 Irth	LC1 D80
10	19	25	NSX100	Micrologic 2.2 M or 6.2 M	12/25	13 Irth	LC1 D80
11	21	25	NSX100	Micrologic 2.2 M or 6.2 M	12/25	13 Irth	LC1 D80
15	28	50	NSX100	Micrologic 2.2 M or 6.2 M	25/50	13 Irth	LC1 D80
18.5	34	50	NSX100	Micrologic 2.2 M or 6.2 M	25/50	13 Irth	LC1 D80
22	40	50	NSX100	Micrologic 2.2 M or 6.2 M	25/50	13 Irth	LC1 D80
30	53	80	NSX100	Micrologic 2.2 M or 6.2 M	50/100 (80)	13 Irth	LC1 D80
37	66	80	NSX100	Micrologic 2.2 M or 6.2 M	50/100 (80)	13 Irth	LC1 D80
45	77	100	NSX100	Micrologic 2.2 M	50/100	13 Irth	LC1 D115 or LC1 F115
55	94	150	NSX160	Micrologic 2.2 M or 6.2 M	70/150	13 Irth	LC1 D150 or LC1 F150
75	127	150	NSX160	Micrologic 2.2 M or 6.2 M	70/150	13 Irth	LC1 D150 or LC1 F150
90	154	185	NSX250	Micrologic 2.2 M or 6.2 M	100/220	13 Irth	LC1 F225
110	188	220	NSX250	Micrologic 2.2 M or 6.2 M	100/220	13 Irth	LC1 F225
132	230	265	NSX400	Micrologic 2.3 M or 6.3 M	160/320	13 Irth	LC1 F265
160	270	320	NSX400	Micrologic 2.3 M or 6.3 M	160/320	13 Irth	LC1 F330
200	340	400/500	NSX630	Micrologic 2.3 M or 6.3 M	250/500	13 Irth	LC1 F400 (70 kA) LC1 F500 (130 kA)
220	366	400/500	NSX630	Micrologic 2.3 M or 6.3 M	250/500	13 Irth	LC1 F400 (70 kA) LC1 F500 (130 kA)
250	415	500	NSX630	Micrologic 2.3 M or 6.3 M	250/500	13 Irth	LC1 F500
300	500	630	NS800L	Micrologic 5.0	320/800	8000	LC1 F630
335	560	630	NS800L	Micrologic 5.0	320/800	8000	LC1 F630
375	620	780	NS1000L	Micrologic 5.0	400/1000	10000	LC1 F780
400	660	780	NS1000L	Micrologic 5.0	400/1000	10000	LC1 F780
450	750	780	NS1000L	Micrologic 5.0	400/1000	10000	LC1 F780

<sup>(1)</sup> For class 30 the contactor rating shall be checked according to 30 s thermal withstand (F range).

<sup>(2)</sup> Reversers: replace LC1 with LC2; start-delta starter: replace LC1 with LC3.

<sup>(3)</sup> Ii for Micrologic 5.0 control unit.

DE119497.eps

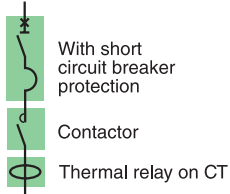

## Circuit breakers, contactors and thermal relays

Performance: Ue = 415 V

Circuit breakers	B	F	N	H	S	L
NSX100/160/250-MA	25 kA	36 kA	50 kA	70 kA	100 kA	130 kA
NSX400/630-MA	25 kA	36 kA	50 kA	70 kA	100 kA	130 kA
NS800L/NS1000L Micrologic 5.0	-	-	-	-	-	130 kA

Starting<sup>(1)</sup>: adjustable class 10 A to 30.

Motors P (kW)	I (A) 415 V	Ie max	Circuit breakers			Contactors <sup>(2)</sup>		Thermal o/l relays	
			Type	Rating (A)	I <sub>rm</sub> (A) <sup>(3)</sup>	Type	Type	I <sub>rth</sub> <sup>(4)</sup>	
0.37	1.1	2.5	NSX100-MA	2.5	32.5	LC1 D40A <sup>(4)</sup>	LTM R08	0.4/8	
0.55	1.5	2.5	NSX100-MA	2.5	32.5	LC1 D40A <sup>(4)</sup>	LTM R08	0.4/8	
0.75	1.8	2.5	NSX100-MA	2.5	32.5	LC1 D40A <sup>(4)</sup>	LTM R08	0.4/8	
1.1	2.6	5	NSX100-MA	6.3	70	LC1 D65A	LTM R08	0.4/8	
1.5	3.4	5	NSX100-MA	6.3	70	LC1 D65A	LTM R08	0.4/8	
2.2	4.8	6.3	NSX100-MA	6.3	82	LC1 D65A	LTM R08	0.4/8	
3	6.2	12.5	NSX100-MA	12.5	163	LC1 D80	LTM R27	1.35/27	
4	8.2	12.5	NSX100-MA	12.5	163	LC1 D80	LTM R27	1.35/27	
5.5	11	12.5	NSX100-MA	12.5	163	LC1 D80	LTM R27	1.35/27	
7.5	14	25	NSX100-MA	25	325	LC1 D80	LTM R27	1.35/27	
10	19	25	NSX100-MA	25	325	LC1 D80	LTM R27	1.35/27	
11	21	25	NSX100-MA	25	325	LC1 D80	LTM R27	1.35/27	
15	28	50	NSX100-MA	50	650	LC1 D80	LTM R100	5/100	
18.5	34	50	NSX100-MA	50	650	LC1 D80	LTM R100	5/100	
22	40	50	NSX100-MA	50	650	LC1 D80	LTM R100	5/100	
30	53	80	NSX100-MA	100	1100	LC1 D80	LTM R100	5/100	
37	66	80	NSX100-MA	100	1100	LC1 D80	LTM R100	5/100	
45	77	100	NSX100-MA	100	1100	LC1 D115	LTM R100	5/100	
						LC1 F115			
55	94	150	NSX160-MA	150	1950	LC1 D150	LTM R08	On CT	
						LC1 F150			
75	127	150	NSX160-MA	150	1950	LC1 D150	LTM R08	On CT	
						LC1 F150			
90	154	185	NSX250-MA	220	2420	LC1 F185	LTM R08	On CT	
110	188	220	NSX250-MA	220	2860	LC1 F225	LTM R08	On CT	
132	230	265	NSX400 - Micrologic 1.3 M	320	3500	LC1 F265	LTM R08	On CT	
160	270	320	NSX400 - Micrologic 1.3 M	320	4000	LC1 F330	LTM R08	On CT	
200	340	400/500	NSX630 - Micrologic 1.3 M	500	5700	LC1 F400 (70 kA)	LTM R08	On CT	
						LC1 F500 (130 kA)			
220	366	400/500	NSX630 - Micrologic 1.3 M	500	6300	LC1 F400 (70 kA)	LTM R08	On CT	
						LC1 F500 (130 kA)			
250	415	500	NSX630 - Micrologic1.3 M	500	6300	LC1 F500	LTM R08	On CT	
300	500	630	NS800L - Micrologic 5.0 - LR off	800	8000	LC1 F630	LTM R08	On CT	
335	560	630	NS800L - Micrologic 5.0 - LR off	800	8000	LC1 F630	LTM R08	On CT	
375	620	780	NS1000L - Micrologic 5.0 - LR off	1000	10000	LC1 F780	LTM R08	On CT	
400	660	780	NS1000L - Micrologic 5.0 - LR off	1000	10000	LC1 F780	LTM R08	On CT	
450	750	780	NS1000L - Micrologic 5.0 - LR off	1000	10000	LC1 F780	LTM R08	On CT	

(1) For installations with a class 30 relay, a derating of 20 % must be apply on circuit breakers and the contactor rating shall be checked according to 30 s thermal withstand (F range).

(2) Reversers: replace LC1 with LC2; start-delta starter: replace LC1 with LC3.

(3) Ii for Micrologic 5.0 control unit.

(4) Iq ≤ 50 kA.

DE113219.eps

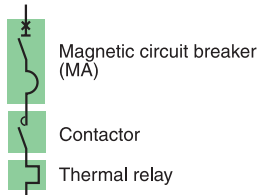

## Circuit breakers, contactors and thermal relays

**Performance<sup>(2)</sup>: Ue = 440 V**

<b>Circuit breakers</b>	<b>H</b>
NS80-MA	65 kA

**Starting<sup>(1)</sup>**: normal, LRD class 10 A, LR9 class 10.

Motors P (kW)	Motors		Circuit breakers			Contactors <sup>(3)</sup> Type	Thermal o/l relays	
	I (A) 440 V	Ie max	Type	Rating (A)	Irm (A)		Type	Irth <sup>(1)</sup>
0.25	0.7	1	NS80H-MA	1.5	13.5	LC1 D09	LRD 05	0.63/1
0.37	1	1.6	NS80H-MA	2.5	22.5	LC1 D09	LRD 06	1/1.6
0.55	1.4	1.6	NS80H-MA	2.5	22.5	LC1 D09	LRD 06	1/1.6
0.75	1.7	2.5	NS80H-MA	2.5	32.5	LC1 D09	LRD 07	1.6/2.5
1.1	2.4	2.5	NS80H-MA	2.5	32.5	LC1 D09	LRD 07	1.6/2.5
1.5	3.1	4	NS80H-MA	6.3	57	LC1 D32	LRD 08	2.5/4
2.2	4.5	6	NS80H-MA	6.3	82	LC1 D32	LRD 10	4/6
3	5.8	6	NS80H-MA	6.3	82	LC1 D32	LRD 10	4/6
4	8	8	NS80H-MA	12.5	113	LC1 D40	LRD 33 12	5.5/8
5.5	10.5	12.5	NS80H-MA	12.5	163	LC1 D40	LRD 33 16	9/13
7.5	13.7	16	NS80H-MA	25	250	LC1 D40	LRD 33 21	12/18
10	19	25	NS80H-MA	25	325	LC1 D40	LRD 33 22	17/25
11	20	25	NS80H-MA	25	325	LC1 D40	LRD 33 22	17/25
15	26.5	32	NS80H-MA	50	450	LC1 D40	LRD 33 53	23/32
18.5	33	40	NS80H-MA	50	550	LC1 D50	LRD 33 55	30/40
22	39	40	NS80H-MA	50	550	LC1 D50	LRD 33 55	30/40
30	52	63	NS80H-MA	80	880	LC1 D65	LRD 33 59	48/65
37	63	63	NS80H-MA	80	880	LC1 D65	LRD 33 59	48/65
45	76	80	NS80H-MA	80	1040	LC1 D80	LRD 33 63	63/80

<sup>(1)</sup> For long starting (class 20), see the correspondence table for thermal relay.

<sup>(2)</sup> Valid for 480 V NEMA.

<sup>(3)</sup> Reversers: replace LC1 with LC2; start-delta starter: replace LC1 with LC3.

DB:119496.eps

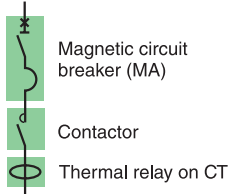

## Circuit breakers, contactors and thermal relays

**Performance <sup>(2)</sup>: U<sub>e</sub> = 440 V**

<b>Circuit breakers</b>	<b>H</b>
NS80-MA	65 kA

**Starting <sup>(1)</sup>**: adjustable class 10 A to 30.

Motors			Circuit breakers			Contactors <sup>(3)</sup>		Thermal o/l relays	
P (kW)	I (A) 440 V	I <sub>e</sub> max	Type	Rating (A)	I <sub>rm</sub> (A)	Type	Type	I <sub>rth</sub> <sup>(1)</sup>	
0.25	0.7	1	NS80H-MA	1.5	13.5	LC1 D40	LTM R08	0.4/8	
0.37	1	2.5	NS80H-MA	2.5	32.5	LC1 D40	LTM R08	0.4/8	
0.55	1.4	2.5	NS80H-MA	2.5	32.5	LC1 D40	LTM R08	0.4/8	
0.75	1.7	2.5	NS80H-MA	2.5	32.5	LC1 D40	LTM R08	0.4/8	
1.1	2.4	2.5	NS80H-MA	2.5	32.5	LC1 D40	LTM R08	0.4/8	
1.5	3.1	6.3	NS80H-MA	6.3	82	LC1 D40	LTM R08	0.4/8	
2.2	4.5	6.3	NS80H-MA	6.3	82	LC1 D40	LTM R08	0.4/8	
3	5.8	6.3	NS80H-MA	6.3	82	LC1 D40	LTM R08	0.4/8	
4	8	12.5	NS80H-MA	12.5	163	LC1 D40	LTM R27	1.35/27	
5.5	10.5	12.5	NS80H-MA	12.5	163	LC1 D40	LTM R27	1.35/27	
7.5	13.7	25	NS80H-MA	25	325	LC1 D40	LTM R27	1.35/27	
10	19	25	NS80H-MA	25	325	LC1 D40	LTM R27	1.35/27	
11	20	25	NS80H-MA	25	325	LC1 D40	LTM R27	1.35/27	
15	26.5	50	NS80H-MA	50	550	LC1 D80	LTM R100	5/100	
18.5	33	50	NS80H-MA	50	550	LC1 D80	LTM R100	5/100	
22	39	50	NS80H-MA	50	550	LC1 D80	LTM R100	5/100	
30	52	80	NS80H-MA	80	1040	LC1 D80	LTM R100	5/100	
37	63	80	NS80H-MA	80	1040	LC1 D80	LTM R100	5/100	
45	76	80	NS80H-MA	80	1040	LC1 D80	LTM R100	5/100	

<sup>(1)</sup> For installations with a class 30 relay, a derating of 20 % must be apply on circuit breakers.

<sup>(2)</sup> Valid for 480 V NEMA.

<sup>(3)</sup> Reversers: replace LC1 with LC2; start-delta starter: replace LC1 with LC3.

DE 119220 eps

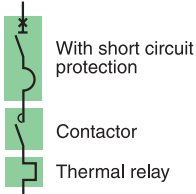

## Circuit breakers, contactors and thermal relays

Performance "iq": Ue = 440 V <sup>(2)</sup>

Circuit breakers	F	N	H	S	L
NSX100/160/250-MA	35 kA	50 kA	65 kA	90 kA	130 kA
NSX400/630 Micrologic 1.3 M	30 kA	42 kA	65 kA	90 kA	130 kA
NS630bL/800L/1000L Micrologic 5.0	-	-	-	-	130 kA

Starting <sup>(1)</sup>: normal, LRD class 10 A, LR9 class 10.

Motors P (kW)	I (A) 440 V	Ie max (A)	Circuit breakers			Contactors <sup>(3)</sup>		Thermal o/l relays	
			Type	Rating (A)	I <sub>rm</sub> (A) <sup>(4)</sup>	Type	Type	Irth <sup>(1)</sup>	
0.37	1	1.6	NSX100-MA	2.5	22.5	LC1 D09	LRD 06 <sup>(5)</sup>	1/1.6	
0.55	1.4	1.6	NSX100-MA	2.5	22.5	LC1 D09	LRD 06 <sup>(5)</sup>	1/1.6	
0.75	1.7	2.5	NSX100-MA	2.5	32.5	LC1 D09	LRD 07 <sup>(5)</sup>	1.6/2.5	
1.1	2.4	2.5	NSX100-MA	2.5	32.5	LC1 D09	LRD 07 <sup>(5)</sup>	1.6/2.5	
1.5	3.1	4	NSX100-MA	6.3	57	LC1 D32	LRD 08 <sup>(6)</sup>	2.5/4	
2.2	4.5	6	NSX100-MA	6.3	82	LC1 D32	LRD 10 <sup>(6)</sup>	4/6	
3	5.8	6	NSX100-MA	6.3	82	LC1 D32	LRD 10 <sup>(6)</sup>	4/6	
4	8	8	NSX100-MA	12.5	113	LC1 D80	LRD 33 12 <sup>(6)</sup>	5.5/8	
5.5	10.5	12.5	NSX100-MA	12.5	163	LC1 D80	LRD 33 16 <sup>(6)</sup>	9/13	
7.5	13.7	18	NSX100-MA	25	250	LC1 D80	LRD 33 21	12/18	
10	19	25	NSX100-MA	25	325	LC1 D80	LRD 33 22	17/25	
11	20	25	NSX100-MA	25	325	LC1 D80	LRD 33 22	17/25	
15	26.5	32	NSX100-MA	50	450	LC1 D80	LRD 33 53	23/32	
18.5	33	40	NSX100-MA	50	550	LC1 D80	LRD 33 55	30/40	
22	39	40	NSX100-MA	50	550	LC1 D80	LRD 33 55	30/40	
30	52	63	NSX100-MA	100	900	LC1 D80	LRD 33 59	48/65	
37	63	63	NSX100-MA	100	900	LC1 D80	LRD 33 59	48/65	
45	76	80	NSX100-MA	100	1100	LC1 D80	LRD 33 63	63/80	
55	90	100	NSX100-MA	100	1300	LC1 D115	LR9 D53 67	60/100	
						LC1 F115	LR9 F53 67		
75	125	150	NSX160-MA	150	1950	LC1 D150	LR9 D53 69	90/150	
						LC1 F150	LR9 F53 69		
90	140	150	NSX160-MA	150	1950	LC1 D150	LR9 D53 69	90/150	
						LC1 F150	LR9 F53 69		
110	178	185	NSX250-MA	220	2420	LC1 F185	LR9 F53 71	132/220	
132	210	265	NSX400 - Micrologic 1.3 M	320	3500	LC1 F265	LR9 F53 71	132/220	
160	256	265	NSX400 - Micrologic 1.3 M	320	3500	LC1 F265	LR9 F73 75	200/330	
200	310	320	NSX400 - Micrologic 1.3 M	320	4160	LC1 F330	LR9 F73 75	200/330	
220	353	400	NSX630 - Micrologic 1.3 M	500	5500	LC1 F400 (70 kA)	LR9 F73 79	300/500	
						LC1 F500 (130 kA)			
250	400	500	NSX630 - Micrologic 1.3 M	500	6500	LC1 F500	LR9 F73 79	300/500	
300	460	500	NSX630 - Micrologic 1.3 M	500	6500	LC1 F500	LR9 F73 79	300/500	
		630	NS800L - Micrologic 5.0 - LR off	800	8000	LC1 F630	LR9 F73 81	380/630	
335	540	630	NS800L - Micrologic 5.0 - LR off	800	8000	LC1 F630	LR9 F73 81	380/630	
375	575	630	NS800L - Micrologic 5.0 - LR off	800	8000	LC1 F630	LR9 F73 81	380/630	
400	611	720	NS800L - Micrologic 5.0 - LR off	800	9600	LC1 F780	TC800/1 + LRD 05	500/800	
450	720	720	NS800L - Micrologic 5.0 - LR off	800	9600	LC1 F780	TC800/1 + LRD 05	500/800	
500	800	780	NS1000L - Micrologic 5.0 - LR off	1000	10000	LC1 F780	TC800/1 + LRD 05	500/800	

<sup>(1)</sup> For long starting (class 20), see the correspondence table for thermal relay.

<sup>(2)</sup> Valid for 480 V NEMA.

<sup>(3)</sup> Reversers: replace LC1 with LC2; start-delta starter: replace LC1 with LC3.

<sup>(4)</sup> Ii for Micrologic 5.0 control unit.

<sup>(5)</sup> Iq ≤ 50 kA.

<sup>(6)</sup> Type 1 only for thermal relay.

DE111922z.eps

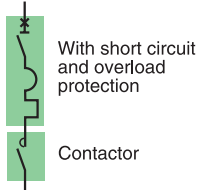

## Circuit breakers, contactors

### Performance "iq": Ue = 440 V<sup>(2)</sup>

Circuit breakers	F	N	H	S	L
NSX100/160/250-MA	35 kA	50 kA	65 kA	90 kA	130 kA
NSX400/630-MA	30 kA	42 kA	65 kA	90 kA	130 kA
NS630bL/800L/1000L Micrologic 5.0	-	-	-	-	130 kA

Starting	Standard IEC 60947-4-1		
Micrologic	2.2 M/2.3 M	6.2 M/6.3 M	5.0
Normal (class)	5, 10	5, 10	10
Long (class)	20	20, 30 <sup>(1)</sup>	20

Motors P (kW)	I (A) 440 V	Ie max	Circuit breakers			Irm (A) <sup>(4)</sup>	Contactors <sup>(3)</sup> Type
			Type	Trip unit	Irth (A)		
7.5	13.7	20	NSX100	Micrologic 2.2 / 6.2 M	12/20	13 Irth	LC1 D80
10	19	25	NSX100	Micrologic 2.2 / 6.2 M	15/25	13 Irth	LC1 D80
11	20	25	NSX100	Micrologic 2.2 / 6.2 M	15/25	13 Irth	LC1 D80
15	26.5	40	NSX100	Micrologic 2.2 / 6.2 M	24/40	13 Irth	LC1 D80
18.5	33	40	NSX100	Micrologic 2.2 / 6.2 M	24/40	13 Irth	LC1 D80
22	39	40	NSX100	Micrologic 2.2 / 6.2 M	24/40	13 Irth	LC1 D80
30	51	80	NSX100	Micrologic 2.2 / 6.2 M	48/80	13 Irth	LC1 D80
37	64	80	NSX100	Micrologic 2.2 / 6.2 M	48/80	13 Irth	LC1 D80
45	76	80	NSX100	Micrologic 2.2 / 6.2 M	48/80	13 Irth	LC1 D80
55	90	100	NSX100	Micrologic 2.2 / 6.2 M	60/100	13 Irth	LC1 D115 or LC1 F115
75	125	150	NSX160	Micrologic 2.2 / 6.2 M	90/150	13 Irth	LC1 D150 or LC1 F150
90	146	150	NSX160	Micrologic 2.2 / 6.2 M	90/150	13 Irth	LC1 D150 or LC1 F150
110	178	185	NSX250	Micrologic 2.2 / 6.2 M	131/220	13 Irth	LC1 F185
132	215	265	NSX400	Micrologic 2.3 / 6.3 M	160/320	13 Irth	LC1 F265
160	256	265	NSX400	Micrologic 2.3 / 6.3 M	160/320	13 Irth	LC1 F265
200	320	320	NSX400	Micrologic 2.3 / 6.3 M	160/320	13 Irth	LC1 F330
220	353	400	NSX630	Micrologic 2.3 / 6.3 M	250/500	13 Irth	LC1 F400 (70 kA) LC1 F500 (130 kA)
250	400	400	NSX630	Micrologic 2.3 / 6.3 M	250/500	13 Irth	LC1 F500
300	460	500	NSX630	Micrologic 2.3 / 6.3 M	250/500	13 Irth	LC1 F500
		630	NS800L	Micrologic 5.0	320/800	8000	LC1 F630
335	540	630	NS800L	Micrologic 5.0	320/800	8000	LC1 F630
375	575	630	NS800L	Micrologic 5.0	320/800	8000	LC1 F630
400	611	720	NS800L	Micrologic 5.0	320/800	9600	LC1 F780
450	720	720	NS800L	Micrologic 5.0	320/800	9600	LC1 F780
500	800	800	NS1000L	Micrologic 5.0	400/1000	10000	LC1 F780

(1) Valid for 480 V NEMA.

(2) For class 30 the contactor rating shall be checked according to 30 s thermal withstand (F range).

(3) Reversers: replace LC1 with LC2; start-delta starter: replace LC1 with LC3.

(4) Ii for Micrologic 5.0 control unit.

DE 119497 eps

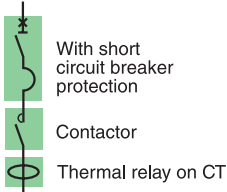

## Circuit breakers, contactors and thermal relays

Performance "I <sub>q</sub> " (kA): U <sub>e</sub> = 440 V <sup>(1)</sup>					
Circuit breakers	F	N	H	S	L
NSX100/160/250-MA	35 kA	50 kA	65 kA	90 kA	130 kA
NSX400/630 Micrologic 1.3 M	30 kA	42 kA	65 kA	90 kA	130 kA
NS630bL/800L/1000L Micrologic 5.0	-	-	-	-	130 kA

Starting <sup>(1)</sup>: adjustable class 10 A - 30.

Motors P (kW)	I (A) 440 V	I <sub>e</sub> max	Circuit breakers			Contactors <sup>(3)</sup>		Thermal o/l relays	
			Type	Rating (A)	I <sub>rm</sub> (A) <sup>(4)</sup>	Type	Type	I <sub>rth</sub>	
0.37	1	2.5	NSX100-MA	2.5	32.5	LC1 D40A <sup>(4)</sup>	LTM R08	0.4/8	
0.55	1.4	2.5	NSX100-MA	2.5	32.5	LC1 D40A <sup>(4)</sup>	LTM R08	0.4/8	
0.75	1.7	2.5	NSX100-MA	2.5	32.5	LC1 D40A <sup>(4)</sup>	LTM R08	0.4/8	
1.1	2.4	2.5	NSX100-MA	2.5	32.5	LC1 D40A <sup>(4)</sup>	LTM R08	0.4/8	
1.5	3.1	6.3	NSX100-MA	6.3	82	LC1 D65A	LTM R08	0.4/8	
2.2	4.5	6.3	NSX100-MA	6.3	82	LC1 D65A	LTM R08	0.4/8	
3	5.8	6.3	NSX100-MA	6.3	82	LC1 D65A	LTM R08	0.4/8	
4	8	12.5	NSX100-MA	12.5	163	LC1 D80	LTM R27	1.35/27	
5.5	10.5	12.5	NSX100-MA	12.5	163	LC1 D80	LTM R27	1.35/27	
7.5	13.7	25	NSX100-MA	25	325	LC1 D80	LTM R27	1.35/27	
10	19	25	NSX100-MA	25	325	LC1 D80	LTM R27	1.35/27	
11	20	25	NSX100-MA	25	325	LC1 D80	LTM R27	1.35/27	
15	26.5	50	NSX100-MA	50	550	LC1 D80	LTM R100	5/100	
18.5	33	50	NSX100-MA	50	550	LC1 D80	LTM R100	5/100	
22	39	50	NSX100-MA	50	550	LC1 D80	LTM R100	5/100	
30	52	80	NSX100-MA	100	1100	LC1 D80	LTM R100	5/100	
37	63	80	NSX100-MA	100	1100	LC1 D80	LTM R100	5/100	
45	76	80	NSX100-MA	100	1100	LC1 D80	LTM R100	5/100	
55	90	100	NSX100-MA	100	1300	LC1 D115	LTM R100	5/100	
						LC1 F115			
75	125	150	NSX160-MA	150	1950	LC1 D150	LTM R08	On CT	
						LC1 F150			
90	140	150	NSX160-MA	150	1950	LC1 D150	LTM R08	On CT	
						LC1 F150			
110	178	185	NSX250-MA	220	2420	LC1 F185	LTM R08	On CT	
132	210	265	NSX400 - Micrologic 1.3 M	320	3500	LC1 F265	LTM R08	On CT	
160	256	265	NSX400 - Micrologic 1.3 M	320	3500	LC1 F265	LTM R08	On CT	
200	310	320	NSX400 - Micrologic 1.3 M	320	4000	LC1 F330	LTM R08	On CT	
220	353	400	NSX630 - Micrologic 1.3 M	500	5500	LC1 F400 (70 kA)	LTM R08	On CT	
						LC1 F500 (130 kA)			
250	400	500	NSX630 - Micrologic 1.3 M	500	6500	LC1 F500	LTM R08	On CT	
300	460	500	NSX630 - Micrologic 1.3 M	500	6500	LC1 F500	LTM R08	On CT	
		630	NS800L - Micrologic 5.0 - LR off	800	8000	LC1 F630	LTM R08	On CT	
335	540	630	NS800L - Micrologic 5.0 - LR off	800	8000	LC1 F630	LTM R08	On CT	
375	575	630	NS800L - Micrologic 5.0 - LR off	800	8000	LC1 F630	LTM R08	On CT	
400	611	720	NS800L - Micrologic 5.0 - LR off	800	9600	LC1 F780	LTM R08	On CT	
450	720	720	NS800L - Micrologic 5.0 - LR off	800	9600	LC1 F780	LTM R08	On CT	
500	800	800	NS1000L - Micrologic 5.0 - LR off	1000	10000	LC1 F780	LTM R08	On CT	

(1) Valid for 480 V NEMA.

(2) For installations with a class 30 relay, a derating of 20 % must be apply on circuit breakers and the contactor rating shall be checked according to 30 s thermal withstand (F range).

(3) Reversers: replace LC1 with LC2; start-delta starter: replace LC1 with LC3.

(4) I<sub>q</sub> ≤ 50 kA.

DE1112Z19.eps

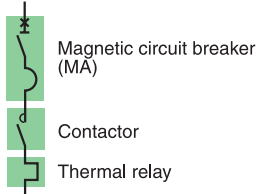

## Circuit breakers, contactors and thermal relays

### Performance: U<sub>e</sub> = 690 V

Circuit breakers	GV2	HB1	HB2	LB
GV2 < L06 or GV2 ≥ L07 + LA9 LB920	50 kA	-	-	-
NSX100/160/250 MA	-	75 kA	100 kA	-
NSX400/630 Micrologic 1.3 M	-	75 kA	100 kA	-
NS800 Micrologic 5.0	-	-	-	75 kA

Starting <sup>(1)</sup>: normal, LRD class 10 A, LR9 class 10.

Motors P (kW)	I (A) 690 V	I <sub>e</sub> max	Circuit breakers			Contactors <sup>(2)</sup>		Thermal o/l relays	
			Type	Rating (A)	I <sub>rm</sub> (A) <sup>(3)</sup>	Type	Type	I <sub>rth</sub> <sup>(1)</sup>	
0.37	0.64	0.64	GV2 L04	0.63		LC1-D09	LRD 05	0.63/1	
0.55	0.87	1	GV2 L05	1		LC1-D09	LRD 05	0.63/1	
0.75	1.1	1.6	GV2 L06	1.6		LC1-D09	LRD 06	1/1.6	
1.1	1.6	2.5	GV2 L07 + LA9 LB920	2.5		LC1-D25	LRD 07	1.6/2.5	
1.5	2.1	2.5	GV2 L07 + LA9 LB920	2.5		LC1-D25	LRD 07	1.6/2.5	
2.2	2.8	4	GV2 L08 + LA9 LB920	4		LC1-D25	LRD 08	2.5/4	
3	3.8	4	GV2 L08 + LA9 LB920	4		LC1-D25	LRD 08	2.5/4	
4	4.9	6	GV2 L10 + LA9 LB920	6.3		LC1-D25	LRD 10	4/6	
5.5	6.7	8	GV2 L14 + LA9 LB920	10		LC1-D25	LRD 12	5.5/8	
7.5	8.9	10	GV2 L14 + LA9 LB920	10		LC1-D25	LRD 14	7/10	
10	11.5	13	GV2 L16 + LA9 LB920	14		LC1-D25	LRD 16	9/13	
15	17	18	GV2 L20 + LA9 LB920	18		LC1-D32	LRD 21	12/18	
18.5	21	21	GV2 L22 + LA9 LB920	25		LC1-D40A	LRD 325	16/24	
22	24	32	GV2 L32 + LA9 LB920	32		LC1-D40A	LRD 332	23/32	
30	32	40	NSX100-MA	50	550	LC1-D80	LRD 33 55 <sup>(4)</sup>	30/40	
37	39	50	NSX100-MA	50	650	LC1-D80	LRD 33 57 <sup>(4)</sup>	37/50	
45	47	50	NSX100-MA	50	650	LC1-D80	LRD 33 57 <sup>(4)</sup>	37/50	
55	57	63	NSX100-MA	100	900	LC1-D150	LR9 F53 63	48/80	
						LC1-F115	LR9 F53 63	48/80	
75	77	80	NSX100-MA	100	1100	LC1-D150	LR9 F53 63	48/80	
						LC1-F115	LR9 F53 63	48/80	
90	93	100	NSX250-MA	150	1350	LC1-F150	LR9 F53 67	60/100	
110	113	115	NSX250-MA	150	1500	LC1-F185	LR9 F53 69	90/150	
132	134	150	NSX250-MA	150	1950	LC1-F330	LR9 F53 71	132/220	
160	162	220	NSX250-MA	220	2860	LC1-F330	LR9 F53 71	132/220	
200	203	220	NSX250-MA	220	2860	LC1-F330	LR9 F53 71	132/220	
220	223	225	NSX400 - Micrologic 1.3 M	320	3200	LC1-F400 (45 kA)	LR9 F73 75	200/330	
						LC1-F500 (100 kA)			
250	250	280	NSX400 - Micrologic 1.3 M	320	3840	LC1-F400 (45 kA)	LR9 F73 75	200/330	
						LC1-F500 (100 kA)			
315	313	330	NSX630 - Micrologic 1.3 M	500	4500	LC1-F500	LR9 F73 75	200/330	
335	335	340	NSX630 - Micrologic 1.3 M	500	4500	LC1-F500	LR9 F73 79	300/500	
355	354	460	NSX630 - Micrologic 1.3 M	500	6000	LC1-F630	LR9 F73 79	300/500	
375	374	460	NSX630 - Micrologic 1.3 M	500	6000	LC1-F630	LR9 F73 79	300/500	
400	400	460	NSX630 - Micrologic 1.3 M	500	6000	LC1-F630	LR9 F73 81	380/630	
450	455	460	NSX630 - Micrologic 1.3 M	500	6000	LC1-F630	LR9 F73 81	380/630	
475	475	480	NS800LB - Micrologic 5.0	800	6400	LC1-F780	LR9 F73 81	380/630	

(1) For long starting (class 20), see the correspondence table for thermal relay.

(2) Reversers: replace LC1 with LC2; start-delta starter: replace LC1 with LC3.

(3) I<sub>i</sub> for Micrologic 5.0 control unit.

(4) Type 1 for thermal relay.

DE113216 eps

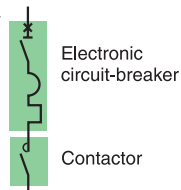

## Circuit breakers, contactors

### Performance: Ue = 690 V

Circuit breakers	GV2	HB1	HB2	LB
GV2 < P06 or GV2 ≥ P07 + LA9 LB920	50 kA	-	-	-
NSX100/160/250 Micrologic 2.2 M/6.2 M	-	75 kA	100 kA	-
NSX400/630 Micrologic 2.2 M/6.2 M	-	75 kA	100 kA	-
NS800 Micrologic 5.0	-	-	-	75 kA

Starting	Standard IEC 60947-4-1		
Micrologic	2.2 M/2.3 M	6.2 M/6.3 M	5.0
Normal (class)	5, 10	5, 10	10
Long (class)	20	20, 30	20

Motors			Circuit breakers				Contactors <sup>(1)</sup>
P (kW)	I (A) 690 V	Ie max	Type	Trip unit	I <sub>rth</sub> (A)	I <sub>rm</sub> (A) <sup>(2)</sup>	Type
0.37	0.63	0.63	GV2 P04		0.63		LC1 D09
0.55	0.87	1	GV2 P05		1		LC1 D09
0.75	1.1	1.6	GV2 P06		1.6		LC1 D09
1.1	1.6	2.5	GV2 P07 + LA9 LB920		2.5		LC1 D25
1.5	2.1	2.5	GV2 P07 + LA9 LB920		2.5		LC1 D25
2.2	2.8	4	GV2 P08 + LA9 LB920		4		LC1 D25
3	3.8	4	GV2 P08 + LA9 LB920		4		LC1 D25
4	4.9	6.3	GV2 P10 + LA9 LB920		6.3		LC1 D25
5.5	6.7	10	GV2 P14 + LA9 LB920		10		LC1 D25
7.5	8.9	10	GV2 P14 + LA9 LB920		10		LC1 D25
10		14	GV2 P16 + LA9 LB920		14		LC1 D25
10	11.6	25	NSX100	Micrologic 2.2 M or 6.2 M	12/25	13 I <sub>rth</sub>	LC1 D80
11	12.8	14	GV2 P16 + LA9 LB920		14		LC1 D32
11	12.8	25	NSX100	Micrologic 2.2 M or 6.2 M	12/25	13 I <sub>rth</sub>	LC1 D80
15	17	18	GV2 P20 + LA9 LB920		18		LC1 D32
15	17	25	NSX100	Micrologic 2.2 M or 6.2 M	12/25	13 I <sub>rth</sub>	LC1 D80
18.5	21	23	GV2 P21 + LA9 LB920		23		LC1 D32
18.5	22	25	NSX100	Micrologic 2.2 M or 6.2 M	12/25	13 I <sub>rth</sub>	LC1 D80
22	24		GV2 P32 + LA9 LB920		32		LC1 D40A
22	24	25	NSX100	Micrologic 2.2 M or 6.2 M	12/25	13 I <sub>rth</sub>	LC1 D80
30	32	50	NSX100	Micrologic 2.2 M or 6.2 M	25/50	13 I <sub>rth</sub>	LC1 D150 / F115
37	39	50	NSX100	Micrologic 2.2 M or 6.2 M	25/50	13 I <sub>rth</sub>	LC1 D150 / F115
45	47	50	NSX100	Micrologic 2.2 M or 6.2 M	25/50	13 I <sub>rth</sub>	LC1 D150 / F115
55	57	63	NSX100	Micrologic 2.2 M or 6.2 M	50/100	13 I <sub>rth</sub>	LC1 D150 / F115
75	77	80	NSX100	Micrologic 2.2 M or 6.2 M	50/100	13 I <sub>rth</sub>	LC1 D150 / F115
90	93	100	NSX250	Micrologic 2.2 M or 6.2 M	70/150	13 I <sub>rth</sub>	LC1 F150
110	113	125	NSX250	Micrologic 2.2 M or 6.2 M	70/150	13 I <sub>rth</sub>	LC1 F185
132	134	150	NSX250	Micrologic 2.2 M or 6.2 M	70/150	13 I <sub>rth</sub>	LC1 F330
160	162	220	NSX250	Micrologic 2.2 M or 6.2 M	100/220	13 I <sub>rth</sub>	LC1 F330
200	203	220	NSX250	Micrologic 2.3 M or 6.3 M	100/220	13 I <sub>rth</sub>	LC1 F330
220	223	280	NSX400	Micrologic 2.3 M or 6.3 M	160/320	13 I <sub>rth</sub>	LC1 F400 (45 kA) LC1 F500 (100 kA)
250	250	280	NSX400	Micrologic 2.3 M or 6.3 M	160/320	13 I <sub>rth</sub>	LC1 F400 (45 kA) LC1 F500 (100 kA)
315	313	340	NSX630	Micrologic 2.3 M or 6.3 M	250/500	13 I <sub>rth</sub>	LC1 F500
335	335	340	NSX630	Micrologic 2.3 M or 6.3 M	250/500	13 I <sub>rth</sub>	LC1 F500
355	354	460	NSX630	Micrologic 2.3 M or 6.3 M	250/500	13 I <sub>rth</sub>	LC1 F630
375	374	460	NSX630	Micrologic 2.3 M or 6.3 M	250/500	13 I <sub>rth</sub>	LC1 F630
400	400	460	NSX630	Micrologic 2.3 M or 6.3 M	250/500	13 I <sub>rth</sub>	LC1 F630
450	455	460	NSX630	Micrologic 2.3 M or 6.3 M	250/500	13 I <sub>rth</sub>	LC1 F630
475	475	480	NS800LB	Micrologic 5.0	320/800	13 I <sub>rth</sub>	LC1 F780

(1) Reversers: replace LC1 with LC2; start-delta starter: replace LC1 with LC3.

(2) Ii for Micrologic 5.0 control unit.

DE1112216.eps

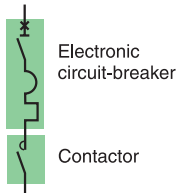

## Circuit breakers, contactors

### Performance: U<sub>e</sub> = 690 V

Circuit breakers	GV2	HB1	HB2	LB
GV2 < L06 or GV2 ≥ L07 + LA9 LB920	50 kA	-	-	-
NSX100/160/250 MA	-	75 kA	100 kA	-
NSX400/630 Micrologic 1.3 M	-	75 kA	100 kA	-
NS800 Micrologic 5.0	-	-	-	75 kA

Starting <sup>(1)</sup>: adjustable.

Motors P (kW)	I (A) 690 V	I <sub>e</sub> max	Circuit breakers			Contactors <sup>(2)</sup>		Thermal o/l relays	
			Type	Rating (A)	I <sub>rm</sub> (A) <sup>(3)</sup>	Type	Type	Ir <sub>th</sub> <sup>(1)</sup>	
0.37	0.64	0.64	GV2 L04	0.63		LC1 D09	LTM R08	0.4/8	
0.55	0.87	1	GV2 L05	1		LC1 D09	LTM R08	0.4/8	
0.75	1.1	1.6	GV2 L06	1.6		LC1 D09	LTM R08	0.4/8	
1.1	1.6	2.5	GV2 L07 + LA9 LB920	2.5		LC1 D25	LTM R08	0.4/8	
1.5	2.1	2.5	GV2 L07 + LA9 LB920	2.5		LC1 D25	LTM R08	0.4/8	
2.2	2.8	4	GV2 L08 + LA9 LB920	4		LC1 D25	LTM R08	0.4/8	
3	3.8	4	GV2 L08 + LA9 LB920	4		LC1 D25	LTM R08	0.4/8	
4	4.9	6	GV2 L10 + LA9 LB920	6.3		LC1 D25	LTM R08	0.4/8	
5.5	6.7	8	GV2 L14 + LA9 LB920	10		LC1 D25	LTM R08	0.4/8	
7.5	8.9	10	GV2 L14 + LA9 LB920	10		LC1 D25	LTM R27	1.35/27	
10	11.5	13	GV2 L16 + LA9 LB920	14		LC1 D25	LTM R27	1.35/27	
11	12.8	14	GV2 L16 + LA9 LB920	14		LC1 D25	LTM R27	1.35/27	
15	17	18	GV2 L20 + LA9 LB920	18		LC1 D32	LTM R27	1.35/27	
18.5	21	21	GV2 L22 + LA9 LB920	25		LC1 D40A	LTM R27	1.35/27	
22	24	32	GV2 L32 + LA9 LB920	32		LC1 D40A	LTM R27	1.35/27	
30	32	50	NSX100-MA	50	650	LC1 D150/F115	LTM R100	5/100	
37	39	50	NSX100-MA	50	650	LC1 D150/F115	LTM R100	5/100	
45	47	50	NSX100-MA	50	650	LC1 D150/F115	LTM R100	5/100	
55	57	63	NSX100-MA	100	1100	LC1 D150/F115	LTM R100	5/100	
75	77	80	NSX100-MA	100	1100	LC1 D150/F115	LTM R100	5/100	
90	93	100	NSX250-MA	150	1350	LC1 F150	LTM R100	5/100	
110	113	115	NSX250-MA	150	1500	LC1 F185	LTM R08	On CT	
132	134	150	NSX250-MA	150	1950	LC1 F330	LTM R08	On CT	
160	162	220	NSX250-MA	220	2420	LC1 F330	LTM R08	On CT	
200	203	220	NSX250-MA	220	2420	LC1 F330	LTM R08	On CT	
220	223	225	NSX400-Micrologic 1.3 M	320	3200	LC1 F400 (45 kA)	LTM R08	On CT	
						LC1 F500 (100 kA)			
250	250	280	NSX400-Micrologic 1.3 M	320	3840	LC1 F400 (45 kA)	LTM R08	On CT	
						LC1 F500 (100 kA)			
315	313	340	NSX630 - Micrologic 1.3 M	500	4500	LC1 F500	LTM R08	On CT	
335	335	340	NSX630 - Micrologic 1.3 M	500	4500	LC1 F500	LTM R08	On CT	
355	354	460	NSX630 - Micrologic 1.3 M	500	6000	LC1 F630	LTM R08	On CT	
375	374	460	NSX630 - Micrologic 1.3 M	500	6000	LC1 F630	LTM R08	On CT	
400	400	460	NSX630 - Micrologic 1.3 M	500	6000	LC1 F630	LTM R08	On CT	
450	455	460	NSX630 - Micrologic 1.3 M	500	6000	LC1 F630	LTM R08	On CT	
475	475	480	NS800LB Micrologic 5 LR Off		6400	LC1 F780	LTM R08	On CT	

<sup>(1)</sup> Observe the recommendations, for installations with a class 30 relay and mounting of the thermal relay on the current transformer.

<sup>(2)</sup> Reversers: replace LC1 with LC2; start-delta starter: replace LC1 with LC3.

<sup>(3)</sup> Ii for Micrologic 5.0 control unit.

S

DE 119219 eps

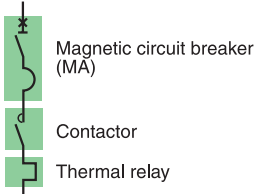

## NS80H-MA circuit breakers, contactor and thermal relay

### Direct-on-line starting

#### Reverser

"Iq" breaking performance: equal to the breaking capacity of the circuit breaker alone.

Starting <sup>(1)</sup>: Direct on line normal start Class 10A/10.

Motors												Circuit breakers		Contactors <sup>(3)</sup>	Thermal relays	
220/230 V		380 V		415 V		440 V <sup>(2)</sup>		500/525 V		660/690 V		Type	Rating (A)	Type	Type	Irth <sup>(1)</sup> (A)
P (kW)	I (A)	P (kW)	I (A)	P (kW)	I (A)	P (kW)	I (A)	P (kW)	I (A)	P (kW)	I (A)					
		<b>0.37</b>	1.2	<b>0.37</b>	1.1	<b>0.37</b>	1	<b>0.55</b>	1.2	<b>0.75</b>	1.2	NS80H-MA	2.5	LC1 D09	LRD 06	1/1.6
		<b>0.55</b>	1.6	<b>0.55</b>	1.5	<b>0.55</b>	1.4	<b>0.75</b>	1.5	<b>1</b>	1.5	NS80H-MA	2.5	LC1 D09	LRD 06	1/1.6
<b>0.37</b>	1.8	<b>0.75</b>	2	<b>0.75</b>	1.8	<b>0.75</b>	1.7					NS80H-MA	2.5	LC1 D09	LRD 07	1.6/2.5
						<b>1.1</b>	2.4	<b>1.1</b>	2	<b>1.5</b>	2	NS80H-MA	2.5	LC1 D09	LRD 07	1.6/2.5
<b>0.55</b>	2.8	<b>1.1</b>	2.8	<b>1.1</b>	2.5			<b>1.5</b>	2.6	<b>2.2</b>	2.8	NS80H-MA	6.3	LC1 D09	LRD 08	2.5/4
		<b>1.5</b>	3.7	<b>1.5</b>	3.5	<b>1.5</b>	3.1			<b>3</b>	3.8	NS80H-MA	6.3	LC1 D09	LRD 08	2.5/4
<b>1.1</b>	4.4	<b>2.2</b>	5	<b>2.2</b>	4.8	<b>2.2</b>	4.5	<b>3</b>	5	<b>4</b>	4.9	NS80H-MA	6.3	LC1 D09	LRD 10	4/6
<b>1.5</b>	6.1	<b>3</b>	6.6	<b>3</b>	6.5	<b>3</b>	5.8	<b>4</b>	6.5	<b>5.5</b>	6.6	NS80H-MA	12.5	LC1 D09	LRD 12	5.5/8
<b>2.2</b>	8.7	<b>4</b>	8.5	<b>4</b>	8.2	<b>4</b>	7.9	<b>5.5</b>	9			NS80H-MA	12.5	LC1 D09	LRD 14	7/10
										<b>7.5</b>	8.9	NS80H-MA	12.5	LC1 D12	LRD 14	7/10
<b>3</b>	11.5	<b>5.5</b>	11.5	<b>5.5</b>	11	<b>5.5</b>	10.4	<b>7.5</b>	12			NS80H-MA	12.5	LC1 D12	LRD 16	9/13
<b>4</b>	14.5	<b>7.5</b>	15.5	<b>7.5</b>	14	<b>7.5</b>	13.7	<b>9</b>	14			NS80H-MA	25	LC1 D18	LRD 21	12/18
				<b>9</b>	17	<b>9</b>	16.9	<b>10</b>	15			NS80H-MA	25	LC1 D18	LRD 21	12/18
										<b>10</b>	11.5	NS80H-MA	25	LC1 D18	LRD 16	9/13
<b>5.5</b>	20	<b>11</b>	22	<b>11</b>	21	<b>11</b>	20.1	<b>11</b>	18.4			NS80H-MA	25	LC1 D25	LRD 22	16/24
										<b>15</b>	17	NS80H-MA	25	LC1 D25	LRD 21	12/18
										<b>18.5</b>	21.3	NS80H-MA	50	LC1 D32	LRD 22	16/24
<b>7.5</b>	28	<b>15</b>	30	<b>15</b>	28	<b>15</b>	26.5	<b>18.5</b>	28.5			NS80H-MA	50	LC1 D32	LRD 32	23/32
								<b>22</b>	33	<b>30</b>	34.6	NS80H-MA	50	LC1 D40A	LRD 340	30/40
<b>11</b>	39	<b>18.5</b>	37	<b>22</b>	40	<b>22</b>	39					NS80H-MA	50	LC1 D40A	LRD 350	37/50
		<b>22</b>	44	<b>25</b>	47			<b>30</b>	45	<b>33</b>	39	NS80H-MA	50	LC1 D50A	LRD 350	37/50
<b>15</b>	52					<b>30</b>	51.5					NS80H-MA	50	LC1 D65A	LRD 365	48/65
										<b>37</b>	42	NS80H-MA	50	LC1 D65A	LRD 350	37/50
<b>18.5</b>	64	<b>30</b>	59	<b>30</b>	55	<b>37</b>	64	<b>37</b>	55			NS80H-MA	80	LC1 D65A	LRD 350	48/65
				<b>37</b>	66							NS80H-MA	80	LC1 D80	LRD 35 61	55/70
										<b>45</b>	49	NS80H-MA	80	LC1 D80	LRD 33 57	37/50
<b>22</b>	75	<b>37</b>	72	<b>45</b>	80	<b>45</b>	76	<b>55</b>	80			NS80H-MA	80	LC1 D80	LRD 33 63	63/80
										<b>55</b>	60	NS80H-MA	80	LC1 D115	LR9 D53 67	60/100
										<b>75</b>	80	NS80H-MA	80	LC1 F115	LR9 F53 63	48/80

(1) For long starting (class 20), see the correspondence table for thermal relay.

(2) Valid for 480 V NEMA.

(3) Reversers: replace LC1 with LC2.

**Note:** where more than one association is possible for a rated power, if the motor starting current is high or unknown, the highest association should be applied.

# Type 1 coordination (IEC 60947-4-1)

DE 11 02 19 eps

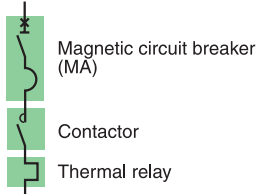

## NSX100 circuit breakers, contactors and thermal relays

### Direct-on-line starting

#### Reverser

"Iq" breaking performance: equal to the breaking capacity of the circuit breaker alone.

Starting <sup>(1)</sup>: normal class 10A/10.

Motors												Circuit breakers		Contactors <sup>(3)</sup>	Thermal relays	
220/230 V		380 V		415 V		440 V <sup>(2)</sup>		500/525 V		660/690 V		Type	Rating (A)	Type	Type	Irth <sup>(1)</sup> (A)
P (kW)	I (A)	P (kW)	I (A)	P (kW)	I (A)	P (kW)	I (A)	P (kW)	I (A)	P (kW)	I (A)					
		0.37	1.2	0.37	1.1	0.37	1	0.55	1.2	0.75	1.2	NSX100B/F/N/H/S/L MA	2.5	LC1 D09	LRD 06	1/1.6
		0.55	1.6	0.55	1.5	0.55	1.4	0.75	1.5	1	1.5	NSX100B/F/N/H/S/L MA	2.5	LC1 D09	LRD 06	1/1.6
0.37	1.8	0.75	2	0.75	1.8	0.75	1.7					NSX100B/F/N/H/S/L MA	2.5	LC1 D09	LRD 07	1.6/2.5
						1.1	2.4	1.1	2	1.5	2	NSX100B/F/N/H/S/L MA	2.5	LC1 D09	LRD 07	1.6/2.5
0.55	2.8	1.1	2.8	1.1	2.5			1.5	2.6	2.2	2.8	NSX100B/F/N/H/S/L MA	6.3	LC1 D09	LRD 08	2.5/4
		1.5	3.7	1.5	3.5	1.5	3.1			3	3.8	NSX100B/F/N/H/S/L MA	6.3	LC1 D09	LRD 08	2.5/4
1.1	4.4	2.2	5	2.2	4.8	2.2	4.5	3	5	4	4.9	NSX100B/F/N/H/S/L MA	6.3	LC1 D09	LRD 10	4/6
1.5	6.1	3	6.6	3	6.5	3	5.8	4	6.5	5.5	6.6	NSX100B/F/N/H/S/L MA	12.5	LC1 D09	LRD 12	5.5/8
2.2	8.7	4	8.5	4	8.2	4	7.9	5.5	9			NSX100B/F/N/H/S/L MA	12.5	LC1 D09	LRD 14	7/10
										7.5	8.9	NSX100B/F/N/H/S/L MA	12.5	LC1 D12	LRD 14	7/10
										7.5	8.9	NSX100HB1/HB2 MA	12.5	LC1 D40A	LRD 14	7/10
3	11.5	5.5	11.5	5.5	11	5.5	10.4	7.5	12			NSX100B/F/N/H/S/L MA	12.5	LC1 D12	LRD 16	9/13
4	14.5	7.5	15.5	7.5	14	7.5	13.7	9	14			NSX100B/F/N/H/S/L MA	25	LC1 D18	LRD 21	12/18
				9	17	9	16.9	10	15			NSX100B/F/N/H/S/L MA	25	LC1 D18	LRD 21	12/18
										10	11.5	NSX100B/F/N/H/S/L MA	25	LC1 D18	LRD 16	9/13
										10	11.5	NSX100HB1/HB2 MA	25	LC1 D40A	LRD 313	9/13
5.5	20	11	22	11	21	11	20.1	11	18.4			NSX100B/F/N/H/S/L MA	25	LC1 D25	LRD 22	17/25
										15	17	NSX100B/F/N/H/S/L MA	25	LC1 D25	LRD 21	12/18
										18.5	21.3	NSX100B/F/N/H/S/L MA	50	LC1 D32	LRD 22	17/25
										18.5	21.3	NSX100HB1/HB2 MA	25	LC1 D40A	LRD 325	17/25
7.5	28	15	30	15	28	15	26.5	18.5	28.5			NSX100B/F/N/H/S/L MA	50	LC1 D32	LRD 32	23/32
								22	33	30	34.6	NSX100B/F/N/H/S/L MA	50	LC1 D40A	LRD 340	30/40
										30	34.6	NSX100HB1/HB2 MA	50	LC1 D80	LRD 33 55	30/40
11	39	18.5	37	22	40	22	39					NSX100B/F/N/H/S/L MA	50	LC1 D40A	LRD 350	37/50
		22	44	25	47			30	45			NSX100B/F/N/H/S/L MA	50	LC1 D50A	LRD 350	37/50
										37	42	NSX100B/F/N/H/S/L MA	50	LC1 D65A	LRD 350	37/50
										37	42	NSX100HB1/HB2 MA	50	LC1 D80	LRD 33 57	37/50
15	52	30	59	30	55	30	51.5					NSX100B/F/N/H/S/L MA	100	LC1 D65A	LRD 365	48/65
18.5	64					37	64	37	55							
										45	49	NSX100B/F/N/H/S/L/HB1/HB2 MA	100	LC1 D80	LRD 33 57	37/50
22	75	37	72	37	72	45	76	55	80			NSX100B/F/N/H/S/L MA	100	LC1 D80	LRD 33 63	63/80
		45	80	45	80											
25	85	45	85									NSX100B/F/N/H/S/L MA	100	LC1 D95	LRD 33 65	80/104
										55	60	NSX100B/F/N/H/S/L/HB1/HB2 MA	100	LC1 D115	LR9 D53 67	60/100
30	100			55	100	55	96			75	80	NSX100B/F/N/H/S/L/HB1/HB2 MA	100	LC1 D115	LR9 D53 67	60/100

(1) For long starting (class 20), see the correspondence table for thermal relay.

(2) Valid for 480V NEMA.

(3) Reversers: replace LC1 with LC2.

Note: where more than one association is possible for a rated power, if the motor starting current is high or unknown, the highest association should be applied.

DE 119220 eps

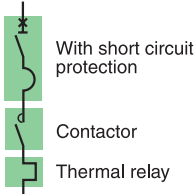

## Schneider Electric NSX160 to NS1250 circuit breakers, Telemecanique contactors and thermal relays

Direct-on-line starting

Reverser

"Iq" breaking performance: equal to the breaking capacity of the circuit breaker alone.

Starting<sup>(1)</sup>: normal, class 10.

Motors												Circuit breakers		Contactors <sup>(3)</sup>	Thermal relays <sup>(1)</sup>	
220/230 V		380 V		415 V		440 V <sup>(2)</sup>		500/525 V		660/690 V		Type	Rating (A)	Type	Type	I <sub>rt</sub> (A)
P (kW)	I (A)	P (kW)	I (A)	P (kW)	I (A)	P (kW)	I (A)	P (kW)	I (A)	P (kW)	I (A)					
37	125	55	105	75	135	75	124	75	110	90	100	NSX160B/F/N/H/S/L MA	150	LC1 D150	LR9 D53 69	90/150
45	150	75	140					90	130	110	120	NSX250HB1/HB2 MA		LC1 F150	LR9 F53 69	100/160
55	180	90	170	90	160	90	156	110	156			NSX250B/F/N/H/S/L/HB1/HB2 MA	220	LC1 F185	LR9 F53 71	132/220
		110	210	110	200	132	215					NSX250B/F/N/H/S/L/HB1/HB2 MA	220	LC1 F225	LR9 F53 71	132/220
								132	190	132	140	NSX250B/F/N/H/S/L/HB1/HB2 MA	220	LC1 F265	LR9 F53 71	132/220
								160	175							
75	250	132	250	132	230	160	256	160	228			NSX400F/N/H/S/L/HB1/HB2 Micrologic 1.3 M	320	LC1 F265	LR9 F73 75	200/330
90	312	160	300	160	270			200	281	200	220	NSX400F/N/H/S/L/HB1/HB2 Micrologic 1.3 M	320	LC1 F330	LR9 F73 75	200/330
								220	240	220	240	NSX630F/N/H/S/L/HB1/HB2 Micrologic 1.3 M	500	LC1 F400	LR9 F73 79	300/500
110	360	200	380	220	380	220	360	220	310			NSX630F/N/H/S/L/HB1/HB2 Micrologic 1.3 M	500	LC1 F400	LR9 F73 75	200/330
								250	270			NSX630F/N/H/S/L/HB1/HB2 Micrologic 1.3 M	500	LC1 F500	LR9 F73 79	300/500
		220	420			250	401			335	335	NSX630F/N/H/S/L/HB1/HB2 Micrologic 1.3 M	500	LC1 F500	LR9 F73 79	300/500
150	480	250	480	250	430			315	445			NSX630F/N/H/S/L/HB1/HB2 Micrologic 1.3 M	500	LC1 F500	LR9 F73 79	300/500
						300	480	335	460			NSX630F/N/H/S/L/HB1/HB2 Micrologic 1.3 M	500	LC1 F630	LR9 F73 81	380/630
								375	400	450	480	NS800N/H-NS1000L Micrologic 5.0 - LR off	800	LC1 F630	LR9 F73 81	380/630
								355	500				800			
								375	530				1000			
								400	570							
160	520	300	570	300	510	335	540	450	630			NS800N/H-NS1000L Micrologic 5.0 - LR off	800	LC1 F630	LR9 F73 81	380/630
200	630	335	630	335	580	375	590					NS800N/H-NS1000L Micrologic 5.0 - LR off	800	LC1 F800	LR2 F83 83	500/800
220	700	375	700	375	650	400	650					NS800N/H-NS1000L Micrologic 5.0 - LR off	800	LC1 F800	LR2 F83 83	500/800
		400	750	400	690	450	720					NS800N/H-NS1000L Micrologic 5.0 - LR off	800	LC1 F800	LR2 F83 83	500/800
												NS800N/H-NS1000L Micrologic 5.0 - LR off	800	LC1 BL33	LR2 F83 83	500/800
								500	530			NS800N/H-NS1000L Micrologic 5.0 - LR off	800	LC1 BL33	LR2 F83 83	500/800
								560	580			NS1000N/H Micrologic 5.0 - LR off	1000	LC1 BM33	LR2 F83 83	500/800
250	800	450	800	450	750			500	700			NS1000N/H Micrologic 5.0 - LR off	1000	LC1 BM33	LR2 F83 85	630/1000
		500	900	500	830	500	800	600	830			NS1000N/H Micrologic 5.0 - LR off	1000	LC1 BM33	LR2 F83 85	630/1000
						560	900	670	920			NS1250N/H Micrologic 5.0 - LR off	1250	LC1 BP33	LR2 F83 85	630/1000
300	970	600	1100	600	1000	670	1080	750	1020							

(1) For long starting (class 20), see the correspondence table for thermal relay.

(2) Valid for 480V NEMA.

(3) Reversers: replace LC1 with LC2.

Note: where more than one association is possible for a rated power, if the motor starting current is high or unknown, the highest association should be applied.

# Type 1 coordination (IEC 60947-4-1)

DE111922z.eps

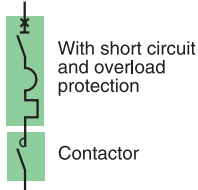

## NSX100 to NS1250 circuit breakers

Direct-on-line starting

Reverser

"Iq" breaking performance: equal to the breaking capacity of the circuit breaker seal.

Starting	Standard IEC 60947-4-1		
Micrologic	2.2 M/2.3 M	6.2 M/6.3 M	5.0
Normal (class)	5, 10	5, 10	10
Long (class)	20	20, 30 <sup>(3)</sup>	20

Motors												Circuit breakers			Contactors <sup>(2)</sup>
220/230 V		380 V		415 V		440 V <sup>(1)</sup>		500/525 V		660/690 V		Type	Trip unit	I <sub>rt</sub> <sup>(A)</sup>	Type
P (kW)	I (A)	P (kW)	I (A)	P (kW)	I (A)	P (kW)	I (A)	P (kW)	I (A)	P (kW)	I (A)				
7.5	28	15	30	15	28	15	26.5	18.5	28.5			NSX100B/F/N/H/S/L	Micrologic 2.2 or 6.2	25/50	LC1 D32
11	39	18.5	37	22	40	22	39	22	33	30	34.6	NSX100B/F/N/H/S/L/HB1/HB2	Micrologic 2.2 or 6.2	25/50	LC1 D40A
		22	44	25	47			30	45	33	39	NSX100B/F/N/H/S/L/HB1/HB2	Micrologic 2.2 or 6.2	25/50	LC1 D50A
15	52	30	59	30	55	30	51.5					NSX100B/F/N/H/S/L	Micrologic 2.2 or 6.2	48/80	LC1 D65A
										37	42	NSX100HB1/HB2	Micrologic 2.2 or 6.2	48/80	LC1 D80
18.5	64					37	64	37	55			NSX100B/F/N/H/S/L	Micrologic 2.2 or 6.2	48/80	LC1 D65A
22	75	37	72	37	72	45	76	55	80	45	49	NSX100B/F/N/H/S/L/HB1/HB2	Micrologic 2.2 or 6.2	48/80	LC1 D80
25	85	45	85									NSX100B/F/N/H/S/L/HB1/HB2	Micrologic 2.2 or 6.2	50/100	LC1 D95
										55	60	NSX100B/F/N/H/S/L/HB1/HB2	Micrologic 2.2 or 6.2	50/100	LC1 D115 or LC1 F115
30	100			55	100	55	96			75	80	NSX100B/F/N/H/S/L/HB1/HB2	Micrologic 2.2 or 6.2	50/100	LC1 D115 or LC1 F115
37	125	55	105	75	135	75	124	75	110	90	100	NSX160B/F/N/H/S/L	Micrologic 2.2 or 6.2	70/150	LC1 D150
45	150	75	140					90	130	110	120	NSX160HB1/HB2			LC1 F150
55	180	90	170	90	160	90	156	110	156			NSX250B/F/N/H/S/L/HB1/HB2	Micrologic 2.2 or 6.2	100/220	LC1 F185
													NSX250B/F/N/H/S/L/HB1/HB2	Micrologic 2.2 or 6.2	100/220
		110	210	110	200	132	215					NSX250B/F/N/H/S/L/HB1/HB2	Micrologic 2.2 or 6.2	100/220	LC1 F265
								132	190	132	140	NSX250B/F/N/H/S/L/HB1/HB2	Micrologic 2.2 or 6.2	100/220	LC1 F265
										160	175	NSX400F/N/H/S/L/HB1/HB2	Micrologic 2.3 or 6.3	160/320	LC1 F265
75	250	132	250	132	230	160	256	160	228			NSX400F/N/H/S/L/HB1/HB2	Micrologic 2.3 or 6.3	160/320	LC1 F265
90	312	160	300	160	270			200	281	200	220	NSX400F/N/H/S/L/HB1/HB2	Micrologic 2.3 or 6.3	160/320	LC1 F330
										220	240				
110	360	200	380	220	380	220	360	220	310	250	270	NSX630F/N/H/S/L/HB1/HB2	Micrologic 2.3 or 6.3	250/500	LC1 F400
		220	420			250	401	315	445	335	335	335	NSX630F/N/H/S/L/HB1/HB2	Micrologic 2.3 or 6.3	250/500
150	480	250	480	250	430			335	460			NSX630F/N/H/S/L/HB1/HB2	Micrologic 2.3 or 6.3	250/500	LC1 F500
						300	480	355	500	375	400	NSX630F/N/H/S/L/HB1/HB2	Micrologic 2.3 or 6.3	250/500	LC1 F630
								375	530	450	480				
160	520	300	570	300	510	335	540	400	570			NS800N/H NS1000L	Micrologic 5.0	320/800 400/1000	LC1 F630
200	630	335	630	335	580	375	590	450	630			NS800N/H NS1000L	Micrologic 5.0	320/800 400/1000	LC1 F630
												NS800N/H NS1000L	Micrologic 5.0	320/800 400/1000	LC1 F800
220	700	375	700	375	650	400	650					NS800N/H NS1000L	Micrologic 5.0	320/800 400/1000	LC1 F800
				400	750	400	690	450	720				NS800N/H NS1000L	Micrologic 5.0	320/800 400/1000
										500	530	NS800N/H	Micrologic 5.0	320/800	LC1 BL33
										560	580	NS1000L		400/1000	
250	800	450	800	450	750			500	700			NS1000N/H	Micrologic 5.0	400/1000	LC1 BM33
								560	760						
		500	900	500	830	500	800	600	830			NS1000N/H	Micrologic 5.0	400/1000	LC1 BM33
		560	900	560	900	560	900	600	830						
300	970	560	1000	560	920	600	960	670	920			NS1250N/H	Micrologic 5.0	630/1250	LC1 BP33
		600	1100	600	1000	670	1080	750	1020			NS1250N/H	Micrologic 5.0	630/1250	LC1 BP33

(1) Valid for 480 V NEMA.

(2) Reversers: replace LC1 with LC2.

(3) For class 30 the contactor rating shall be checked according to 30 s thermal withstand (F range).

Note: where more than one association is possible for a rated power, if the motor starting current is high or unknown, the highest association should be applied.

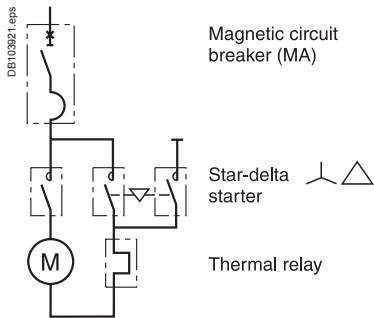

## NS80H-MA and NSX100 circuit breakers, contactors and thermal relays

### Star-delta starting

"Iq" breaking performance: equal to the breaking capacity of the circuit breaker alone.  
Starting: normal.

Motors								Circuit breakers		Contactors	Thermal relays	
220/230 V		380 V		415 V		440 V <sup>(1)</sup>		Type	Rating (A)	Type	Type	Irth (A)
P (kW)	I (A)	P (kW)	I (A)	P (kW)	I (A)	P (kW)	I (A)					
0.55	2.8	1.5	3.7	1.5	3.5	1.5	3.1	NS80H-MA	6.3	LC3 D09	LRD 07	1.6/2.5
1.1	4.4	2.2	5	2.2	4.8	2.2	4.5	NS80H-MA	6.3	LC3 D09	LRD 08	2.5/4
1.5	6.1	3	6.6	3	6.5	3	5.8	NS80H-MA	12.5	LC3 D09	LRD 08	2.5/4
2.2	8.7	4	8.5	4	8.2	4	7.9	NS80H-MA	12.5	LC3 D09	LRD 10	4/6
3	11.5	5.5	11.5	5.5	11	5.5	10.4	NS80H-MA	12.5	LC3 D09	LRD 12	5.5/8
4	14.5	7.5	15.5	7.5	14	7.5	13.7	NS80H-MA	25	LC3 D09	LRD 14	7/10
5.5	20			9	17	9	16.9	NS80H-MA	25	LC3 D12	LRD 16	9/13
		11	22	11	21	11	20.1	NS80H-MA	25	LC3 D12	LRD 16	9/13
7.5	28	15	30	15	28	15	26.5	NS80H-MA	50	LC3 D18	LRD 21	12/18
11	39	18.5	37	22	40	22	39	NS80H-MA	50	LC3 D18	LRD 22	17/25
		22	44	25	47			NS80H-MA	50	LC3 D32	LRD 32	23/32
15	52					30	51.5	NS80H-MA	80	LC3 D32	LRD 32	23/32
				30	55			NS80H-MA	80	LC3 D32	LRD 32	23/32
18.5	64	30	59	37	66	37	64	NS80H-MA	80	3 x LC1 D40A	LRD 340	30/40
		37	72					NS80H-MA	80	3 x LC1 D40A	LRD 350	37/50
22	75			45	80	45	76	NS80H-MA	80	3 x LC1 D50A	LRD 350	37/50
0.55	2.8	1.5	3.7	1.5	3.5	1.5	3.1	NSX100B/F/N/H/S/L MA	6.3	LC3 D09	LRD 07	1.6/2.5
1.1	4.4	2.2	5	2.2	4.8	2.2	4.5	NSX100B/F/N/H/S/L MA	6.3	LC3 D09	LRD 08	2.5/4
1.5	6.1	3	6.6	3	6.5	3	5.8	NSX100B/F/N/H/S/L MA	12.5	LC3 D09	LRD 08	2.5/4
2.2	8.7	4	8.5	4	8.2	4	7.9	NSX100B/F/N/H/S/L MA	12.5	LC3 D09	LRD 10	4/6
3	11.5	5.5	11.5	5.5	11	5.5	10.4	NSX100B/F/N/H/S/L MA	12.5	LC3 D09	LRD 12	5.5/8
4	14.5	7.5	15.5	7.5	14	7.5	13.7	NSX100B/F/N/H/S/L MA	25	LC3 D09	LRD 14	7/10
5.5	20			9	17	9	16.9	NSX100B/F/N/H/S/L MA	25	LC3 D12	LRD 16	9/13
		11	22	11	21	11	20.1	NSX100B/F/N/H/S/L MA	25	LC3 D12	LRD 16	9/13
7.5	28	15	30	15	28	15	26.5	NSX100B/F/N/H/S/L MA	50	LC3 D18	LRD 21	12/18
11	39	18.5	37	22	40	22	39	NSX100B/F/N/H/S/L MA	50	LC3 D18	LRD 22	17/25
		22	44	25	47			NSX100B/F/N/H/S/L MA	100	LC3 D32	LRD 32	23/32
15	52					30	51.5	NSX100B/F/N/H/S/L MA	100	LC3 D32	LRD 32	23/32
				30	55			NSX100B/F/N/H/S/L MA	100	LC3 D32	LRD 32	23/32
18.5	64	30	59	37	66	37	64	NSX100B/F/N/H/S/L MA	100	3 x LC1 D40A	LRD 340	30/40
		37	72					NSX100B/F/N/H/S/L MA	100	2 x LC1 D50A + 1 x LC1 D40A	LRD 350	37/50
22	75			45	80	45	76	NSX100B/F/N/H/S/L MA	100	2 x LC1 D50A + 1 x LC1 D40A	LRD 350	37/50
25	85	45	85					NSX100B/F/N/H/S/L MA	100	2 x LC1 D50A + 1 x LC1 D40A	LRD 350	37/50
30	100			55	100	55	96	NSX100B/F/N/H/S/L MA	100	2 x LC1 D65A + 1 x LC1 D40A	LRD 365	48/65

(1) Valid for 480 V NEMA.

# Type 1 coordination (IEC 60947-4-1)

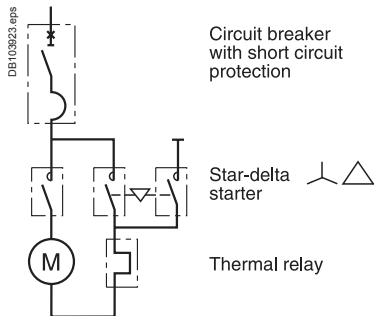

## NSX160 to NS1000 circuit breakers, contactors and thermal relays

### Star-delta starting

"I<sub>q</sub>" breaking performance: equal to the breaking capacity of the circuit breaker alone.

Starting: normal.

Motors								Circuit breakers		Contactors	Thermal relays	
220/230 V		380 V		415 V		440 V <sup>(1)</sup>		Type	Rating (A)	Type	Type	I <sub>rt</sub> h (A)
P (kW)	I (A)	P (kW)	I (A)	P (kW)	I (A)	P (kW)	I (A)					
		<b>55</b>	105					NSX160B/F/N/H/S/L MA	150	LC3 D80	LRD 33 59	48/65
<b>37</b>	125			<b>75</b>	135	<b>75</b>	124	NSX160B/F/N/H/S/L MA	150	LC3 D80	LRD 33 63	63/80
<b>45</b>	150	<b>75</b>	140					NSX160B/F/N/H/S/L MA	150	LC3 D115 LC3 F115	LR9 D53 67 LR9 F53 67	60/100
		<b>90</b>	170	<b>90</b>	160	<b>90</b>	156	NSX250B/F/N/H/S/L MA	220	LC3 D115 LC3 F115	LR9 D53 67 LR9 F53 67	60/100
<b>55</b>	180					<b>110</b>	180	NSX250B/F/N/H/S/L MA	220	LC3 D115 LC3 F115	LR9 D53 69 LR9 F53 69	90/150
		<b>110</b>	210	<b>110</b>	200			NSX250B/F/N/H/S/L MA	220	LC3 D115 LC3 F115	LR9 D53 69 LR9 F53 69	90/150
						<b>132</b>	215	NSX250B/F/N/H/S/L MA	220	LC3 D150 LC3 F150	LR9 D53 69 LR9 F53 69	90/150
<b>75</b>	250	<b>132</b>	250	<b>132</b>	230			NSX400F/N/H/S/L Micrologic 1.3 M	320	LC3 D150 LC3 F150	LR9 D53 69 LR9 F53 69	90/150
<b>90</b>	312	<b>160</b>	300	<b>160</b>	270	<b>160</b>	256	NSX400F/N/H/S/L Micrologic 1.3 M	320	LC3 F185	LR9 F53 71	132/220
<b>110</b>	360	<b>200</b>	380	<b>220</b>	380	<b>220</b>	360	NSX630F/N/H/S/L Micrologic 1.3 M	500	LC3 F265	LR9 F73 75	200/330
		<b>220</b>	420			<b>250</b>	401	NSX630F/N/H/S/L Micrologic 1.3 M	500	LC3 F265	LR9 F73 75	200/330
<b>150</b>	480	<b>250</b>	480	<b>250</b>	430			NSX630F/N/H/S/L Micrologic 1.3 M	500	LC3 F330	LR9 F73 75	200/330
						<b>300</b>	480	NSX630F/N/H/S/L Micrologic 1.3 M	500	LC3 F330	LR9 F73 75	200/330
<b>160</b>	520	<b>300</b>	570	<b>300</b>	510	<b>335</b>	540	NS800N/H-NS1000L Micrologic 5.0 - LR off	800 1000	LC3 F400	LR9 F73 75	200/330
				<b>335</b>	580	<b>375</b>	590	NS800N/H-NS1000L Micrologic 5.0 - LR off	800 1000	LC3 F400	LR9 F73 79	300/500

<sup>(1)</sup> Valid for 480 V NEMA.

**Note:** where more than one association is possible for a rated power, if the motor starting current is high or unknown, the highest association should be applied.

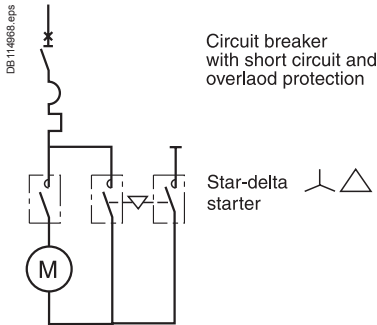

## NSX100 to NS1000 circuit breakers, contactors

### Star-delta starting

"Iq" breaking performance: equal to the breaking capacity of the circuit breaker alone.  
Starting: normal.

Motors								Circuit breakers			Contactors
220/230 V		380 V		415 V		440 V <sup>(1)</sup>		Type	Trip unit	I <sub>rth</sub> (A)	Type
P (kW)	I (A)	P (kW)	I (A)	P (kW)	I (A)	P (kW)	I (A)				
7.5	28	15	30	15	28	15	26.5	NSX100B/F/N/H/S/L	Micrologic 2.2 M or 6.2 E-M	25/50	LC3 D18
11	39	18.5	37	22	40	22	39	NSX100B/F/N/H/S/L	Micrologic 2.2 M or 6.2 E-M	25/50	LC3 D18
		22	44	25	47			NSX100B/F/N/H/S/L	Micrologic 2.2 M or 6.2 E-M	25/50	LC3 D32
15	52					30	51.5	NSX100B/F/N/H/S/L	Micrologic 2.2 M or 6.2 E-M	50/100	LC3 D32
				30	55			NSX100B/F/N/H/S/L	Micrologic 2.2 M or 6.2 E-M	50/100	LC3 D32
18.5	64	30	59	37	66	37	64	NSX100B/F/N/H/S/L	Micrologic 2.2 M or 6.2 E-M	50/100	3 x LC1 D40A
		37	72					NSX100B/F/N/H/S/L	Micrologic 2.2 M or 6.2 E-M	50/100	2 x LC1 D50A + 1 x LC1 D40A
22	75			45	80	45	76	NSX100B/F/N/H/S/L	Micrologic 2.2 M or 6.2 E-M	50/100	2 x LC1 D50A + 1 x LC1 D40A
25	85	45	85					NSX100B/F/N/H/S/L	Micrologic 2.2 M or 6.2 E-M	50/100	2 x LC1 D50A + 1 x LC1 D40A
30	100			55	100	55	96	NSX100B/F/N/H/S/L	Micrologic 2.2 M or 6.2 E-M	50/100	2 x LC1 D65A + 1 x LC1 D40A
		55	105					NSX160B/F/N/H/S/L	Micrologic 2.2 M or 6.2 E-M	70/150	LC3 D80
37	125	75	140	75	135	75	124	NSX160B/F/N/H/S/L	Micrologic 2.2 M or 6.2 E-M	70/150	LC3 D80
45	150	75	140					NSX160B/F/N/H/S/L	Micrologic 2.2 M or 6.2 E-M	70/150	LC3 D115 or LC3 F115
		90	170	90	160	90	156	NSX250B/F/N/H/S/L	Micrologic 2.2 M or 6.2 E-M	100/220	LC3 D115 or LC3 F115
55	180	110	210	110	200	110	180	NSX250B/F/N/H/S/L	Micrologic 2.2 M or 6.2 E-M	100/220	LC3 D115 or LC3 F115
						132	215	NSX250B/F/N/H/S/L	Micrologic 2.2 M or 6.2 E-M	100/220	LC3 D150 or LC3 F150
75	250	132	250	132	230			NSX400F/N/H/S/L	Micrologic 2.3 M or 6.3 E-M	160/320	LC3 D150 or LC3 F150
90	312	160	300	160	270	160	256	NSX400F/N/H/S/L	Micrologic 2.3 M or 6.3 E-M	160/320	LC3 F185
110	360	200	380	220	380	220	360	NSX630F/N/H/S/L	Micrologic 2.3 M or 6.3 E-M	250/500	LC3 F265
		220	420			250	401	NSX630F/N/H/S/L	Micrologic 2.3 M or 6.3 E-M	250/500	LC3 F265
150	480	250	480	250	430			NSX630F/N/H/S/L	Micrologic 2.3 M or 6.3 E-M	250/500	LC3 F330
						300	480	NSX630F/N/H/S/L	Micrologic 2.3 M or 6.3 E-M	250/500	LC3 F330
160	520	300	570	300	510	335	540	NS800N/H NS1000L	Micrologic 5.0	320/800 400/1000	LC3 F400
				335	580	375	590	NS800N/H NS1000L	Micrologic 5.0	320/800 400/1000	LC3 F400

<sup>(1)</sup> Valid for 480 V NEMA.

**Note:** where more than one association is possible for a rated power, if the motor starting current is high or unknown, the highest association should be applied.