

1. INTRODUCTION

1.1 About User Manual

This User Manual is designed to help you for quick installation of RT. Before installation and operation please, read this section very carefully.

1.2 Precautions for Safe Use and Installation

- 1) Maintenance, installation and operation of RT must be performed only by the qualified electricians.
- 2) Disconnect power before working on the equipment.
- 3) Do not operate RT undervoltage.
- 4) Do not open the RT's housing. There are no user servicable parts inside it.
- 5) RT is connected to the network by means of a current transformer. Do not disconnect the current transformer terminals, if you disconnect them, be sure to short circuit or connect them to another parallel load having sufficiently low impedance. In case of failure dangerously high voltage at the secondary side of current transformer may cause an electric shock.
- 6) Do not use this product for any other purpose than its original task.
- 7) When the device is connected to the network, do not remove the front panel.
- 8) Do not clean the device with solvent or the like. Only clean with a dried cloth.
- 9) Verify correct terminal connections when wiring.
- 10) Electrical equipment should be serviced only by your competent seller.
- 11) Only for rack panel mounting.

2. GENERAL

Power Factor Controllers are used for measurement and control of power factor control units for central reactive power compensation. The Power Factor measured by RT is compared with the set point values in order to provide necessary compensation. Power Factor Controller switches capacitor steps ON and OFF automatically. RT is microcontroller relay, designed for flush mounting with rear plug-in connectors. In addition it displays the system's $\text{Cos}\phi$ in Automatic Operating Mode, RT displays the RMS value of Voltage (V), Current (I), Active Power (W), Reactive Power (kvar) and Apparent Power (VA) of measuring phase.

3. FRONT PANEL SPECIFICATIONS

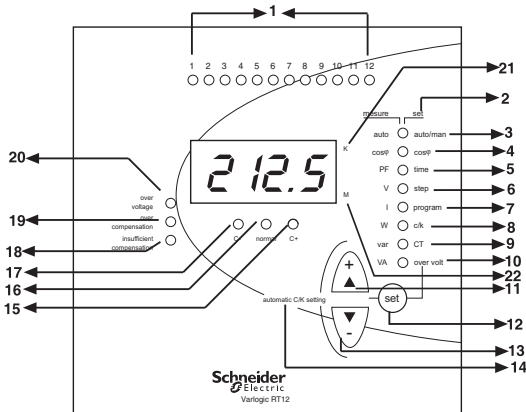

On the front panel of RT, there are warning LEDs, display and 3 buttons for settings.

3.1 Buttons and LEDs

- 1, 2, 12 : Shows the status of each capacitor steps. [Steps according to model (etc. RT12 is 12 steps)]
- 2.SET Menu : Shows the Menu options that correspond to the LEDs.
3. AUTO/MAN LED : If this LED is continuously ON, RT is in Automatic Mode. If it is blinking RT is in Manual Mode. By pressing SET button for 3 seconds, you enter to Menu and change operating Mode. If any button is not pressed within 5 min. in Manual mode, RT returns to Automatic Mode. (Refer to: 5.1)
4. $\text{Cos}\phi$ LED : By pressing SET button for 3 seconds ; $\text{Cos}\phi$ Adjustment can be made by selecting this LED. (Refer to: 5.3). In Automatic Mode, when $\text{Cos}\phi$ LED is selected by pressing UP and DOWN buttons, systems $\text{Cos}\phi$ and ind /cap state is displayed. (Refer to: 5.10)
5. TIME/PF LED : By pressing SET button for 3 seconds; you enter to Menu, response and reconnection delay time adjustment is made by selecting this LED. (Refer to: 5.4) In Automatic Mode, when this LED is selected by pressing UP and DOWN buttons, systems Power Factor is displayed. (Refer to: 5.11)
6. STEP/V LED : By pressing SET button for 3 seconds; you enter to Menu and Step Number adjustment is made by selecting this LED. (Refer to: 5.5) In Automatic Mode, when this LED is selected by pressing UP and DOWN buttons phase voltage (V) is displayed. (Refer to: 5.12)
7. PROGRAM/I LED : By pressing SET button for 3 seconds; you enter to Menu and Power Sequence adjustment is made by selecting this LED. (Refer to: 5.6) In Automatic Mode, when this LED is selected by pressing UP and DOWN buttons, phase current (I) is displayed (Refer to: 5.12)
8. C/k - W LED : By pressing SET button for 3 seconds; you enter to Menu and Manual C/k adjustment is made by selecting this LED. (Refer to: 5.7) In Automatic Mode when this LED is selected by pressing UP and DOWN buttons, systems Active Power (W) is displayed. (Refer to: 5.13)
9. CT - var LED : By pressing SET button for 3 seconds; you enter to Menu and Current Transformer Ratio adjustment is made by selecting this LED. (Refer to: 5.8) In Automatic Mode when this LED is selected by pressing UP and DOWN buttons, systems Reactive Power (var) is displayed. (Refer to: 5.14)

10. over volt /VA LED : By pressing SET button for 3 seconds; you enter to Menu and Protection of Capacitor Steps Against Over Voltage function is made by selecting this LED. (Refer to: 5.9) In Automatic Mode when this LED is selected by pressing UP and DOWN buttons, systems Apparent Power (VA) is displayed. (Refer to: 5.15)
11. UP Button : To move up in the Menu.
12. SET Button : Enter button for different settings.
13. DOWN Button : To move down in the Menu.
14. Automatic C/k Setting : Automatical C/k adjustment is started by pressing UP and DOWN buttons together at the same time. (Refer to: 5.2)
15. C+ LED : This LED is ON when RT switches capacitor steps on.
16. NORMAL LED : This LED is ON when the targeted compensation is achieved.
17. C- LED : This LED is ON when RT switches capacitor steps off.
18. Low Power Factor LED : This warning LED is ON when low power factor occurs. (Refer to: 6.1.2)
19. Over Compensation LED : This warning LED is ON when over compensation occurs. (Refer to: 6.1.3)
20. Over Voltage LED : This warning LED is ON when over voltage occurs. (Refer to: 6.1.1)
21. K (Kilo) LED : When this LED is ON displayed value must be multiplied by 1000.
22. M (Mega) LED : When this LED is ON displayed value must be multiplied by 10^6 .

4. CONNECTION DIAGRAM

400V Line to Line Connection

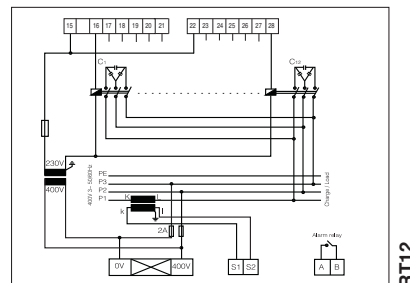
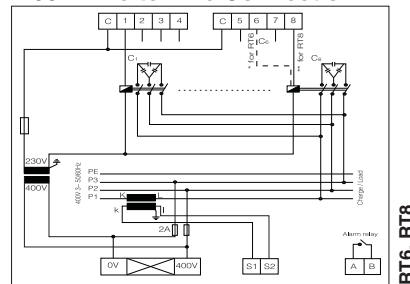

230V Line to Line Connection

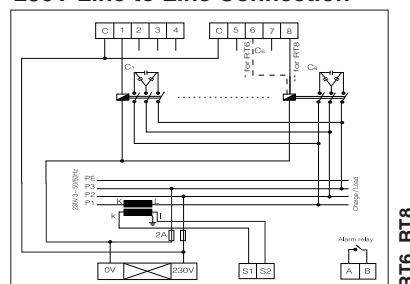

⚠ The "C" terminal blocks are short-circuited inside the controller.

Warnings:

- a) Check the right connection of the CT (location, polarity) and of the voltage supply phase.
- b) Connection of protection device is highly recommended between the network and the power supply input of the device.
- c) All the used fuses must be gG type and the current values of the fuses must be 2A, 3A and 6A.

5. CONTROLS AND MENU OPERATIONS

All settings are made by Menu. The set values, except of operating mode are kept in memory even if the device is switched off. When it is switched on, it starts compensation with the values stored in the memory in Automatic Operating Mode. After entering Menu by pressing SET button 3 seconds and if you don't make any adjustments during 20 seconds, RT operates with the previously stored values.

To quit Menu without any storing operation, UP-DOWN buttons are pressed until the ESC symbol is displayed and then SET button is pressed. The details of controls and adjustments are explained in the following sections.

5.1 Selection of Operating Mode (Automatic / Manual Mode)

Two Operating Modes are available for switching on/off the capacitor steps.

- 1) Automatic Operating Mode: The capacitor steps are controlled by RT, automatically.
- 2) Manual Operating Mode: the capacitor steps are switched on/off, manually. RT returns to Automatic mode if any button is not pressed within 5 minutes.

Mode selection is done as followed.

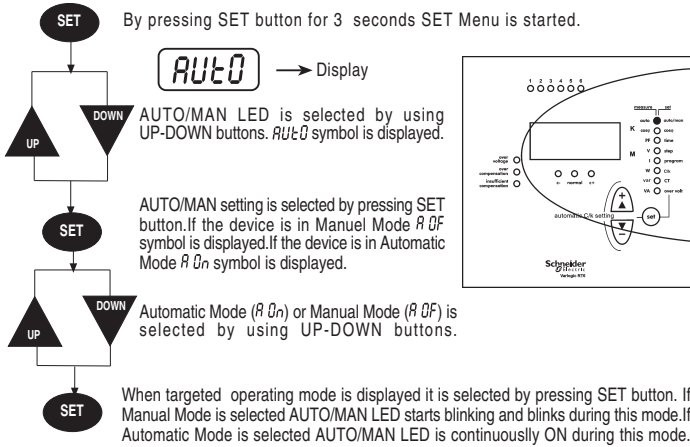

5.1.1 Switching of the Capacitor Steps Manually

When RT is in Manual Mode, capacitor steps are connected by pressing UP button. Each time UP button is pressed, C+ light is ON and one step is connected after set response delay time.

NORMAL light will be ON after the connection of the step. This operation must be repeated to connect more steps.

Capacitor steps are disconnected by pressing DOWN button. Each time DOWN button is pressed, C- light is ON and one step is disconnected after set response delay time. NORMAL light will be ON after the disconnection of the step. This operation must be repeated to disconnect more steps.

5.2 Automatic C/k Adjustment

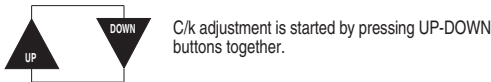

5.3 Cosφ Adjustment

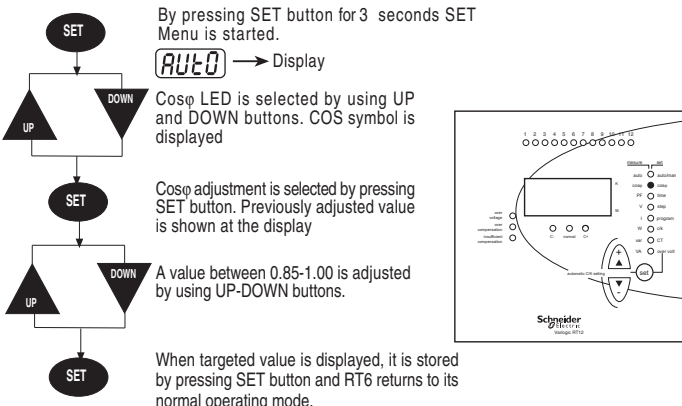

5.4 Response and Reconnection Delay Time Adjustment

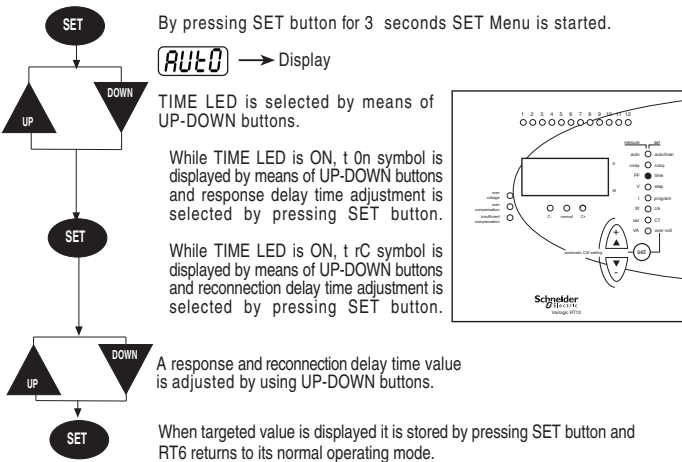

Note: Factory set values are 10 sec. for response delay and 50 sec. for reconnection delay

5.5 Step Number Selection

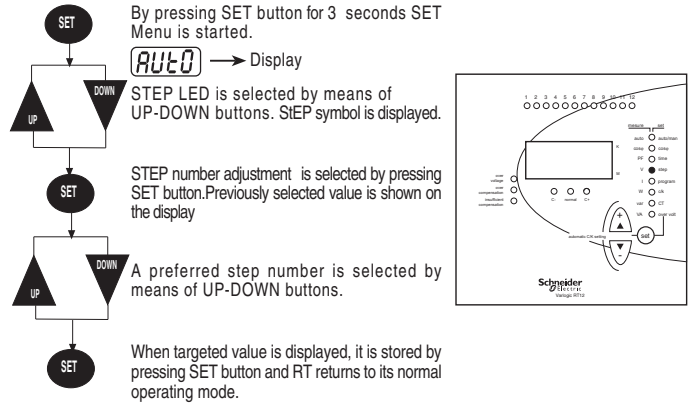

5.6 Switching Program Selection

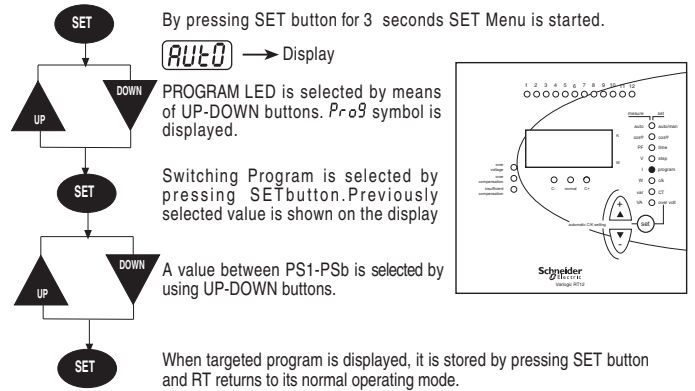

5.7 Selection of C/k Value by the User

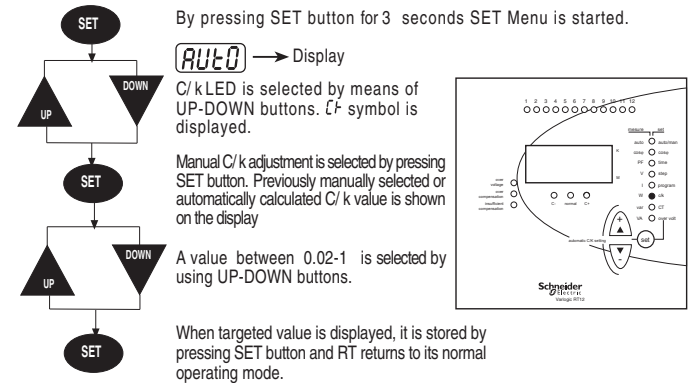

5.8 Selection of Current Transformer Primary Value

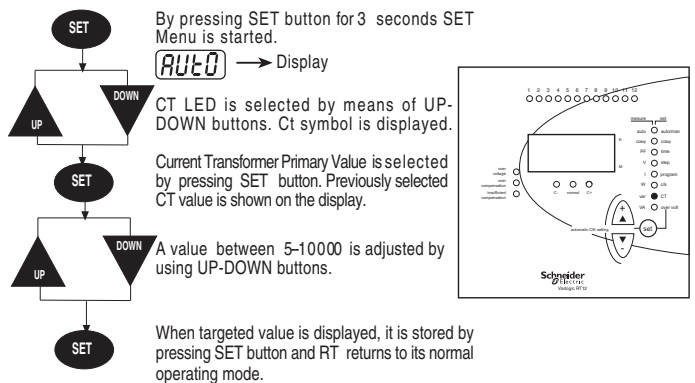

5.9 Protection of Capacitor Steps Against Over Voltage

This function can be programmed between 240-275V (for 185 ... 265V AC) or 410-480V (for 320 ... 460V AC) or disabled O OF (Over Voltage Protection Off). If "Over Voltage" occurs, all the capacitor steps switch off, OVER VOLTAGE LED turns on and alarm relay activates with 1 min. delay. And if RT is on Manual Mode, it switches to Automatic Mode. If O OF (Over Voltage Protection Off) is selected; Over Voltage Protection is disabled. Setting can be made as followed:

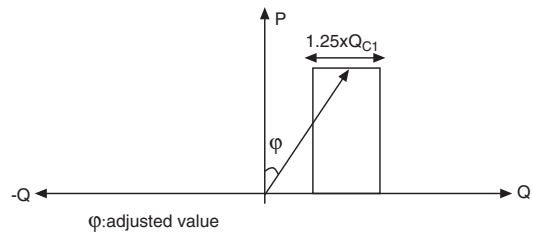
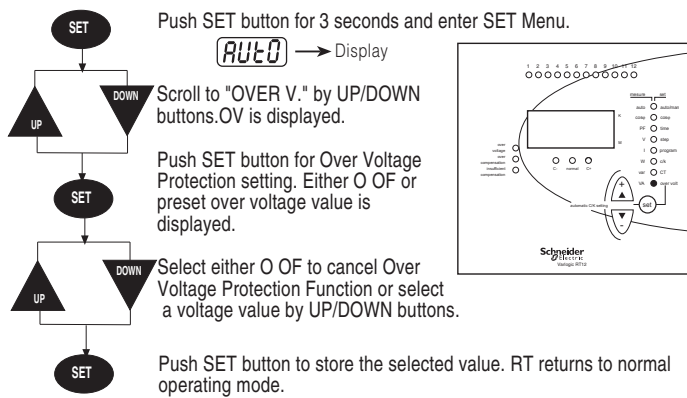

5.10 Display of Cosφ Value

When RT is in Manual Operating Mode, Cosφ value and inductive/capacitive state is always displayed. When Cosφ value is negative, the system is capacitive and if Cosφ value is positive, the system is inductive. In Automatic Operating Mode, system's present Cosφ value and ind./cap. state may be displayed by selecting the Cosφ LED, by means of UP-DOWN buttons.

5.11 Display of Power Factor (PF) Value

When RT is in Automatic Operating Mode (AUTO/MAN LED is continuously ON), PF LED is selected by means of UP-DOWN buttons and system's Power Factor value is displayed. This option is disabled in Manual Operating Mode.

Important Definition: Cosφ is defined as Displacement Power Factor and relative to the fundamental harmonic only. PF is defined as Total Power Factor and relative to the all harmonics including fundamental harmonic. In a system without harmonics, PF and Cosφ are equal to each other.

5.12 Displaying Voltage and Current RMS Values

When RT is in Automatic Operating Mode (AUTO/MAN LED is ON), V LED is selected, RMS Voltage (V) value is displayed. If I LED is selected, RMS Current (I) value is displayed. Displayed current and voltage values are of the phase where CT is connected. These options are disabled in Manual Operating Mode.

5.13 Display of Active Power (W) Value

When RT is in Automatic Operating Mode (AUTO/MAN LED is continuously ON), W LED is selected by means of UP-DOWN buttons and system's Active Power value is displayed. This option is disabled in Manual Operating Mode.

5.14 Display of Reactive Power (var) Value

When RT is in Automatic Operating Mode (AUTO/MAN LED is continuously ON), var LED is selected by means of UP-DOWN buttons and system's Reactive Power value is displayed. This option is disabled in Manual Operating Mode.

5.15 Display of Apparent Power (VA) Value

When RT is in Automatic Operating Mode (AUTO/MAN LED is continuously ON), VA LED is selected by means of UP-DOWN buttons and system's Apparent Power value is displayed. This option is disabled in Manual Operating Mode.

5.16 Correction of Energy Flow Direction

If the RT's energy flow direction is incorrect, then it is automatically corrected during first energize. There is no need to push any button for this correction. RT, corrects the energy flow direction by (sequentially) switching on and off 1st capacitor step. C/k value is not calculated during this process.

Note : In order to have a right correction, the capacitors and the circuit breakers -especially connected on the 1st step- must be healthy and in good condition. Otherwise, compensation will fail and also energy flow direction can not be corrected.

6. DESCRIPTION

6.1 Errors and Warnings

The Alarm Relay is activated if the following "errors" occur.

6.1.1 Over Voltage

If the phase-phase voltage exceeds or equals to preset Over Voltage Value which is programmable (for 185V ... 265V : 240-275V, for 320V ... 460V : 410-480V), then RT6 waits for 1 minute. At the end of 1 minute if there is still over voltage then OVER VOLTAGE LED turns on. Depending on selection of Over Voltage Protection Function (Pls. refer to 5.9), RT switches off all the capacitor steps or continues to compensation.

6.1.2 Low Power Factor

When target power factor is not reached to target value, although all the capacitor steps have been connected, Low power factor's LED is ON and the Alarm Relay is activated after 1 min. delay.

6.1.3 Over Compensation

If the system is still capacitive although all the capacitor steps are disconnected, OVER COMPENSATION LED is ON and Alarm Relay is activated after 1 min. delay.

6.2 Target Cosφ

The target Cosφ value can be adjusted between 0.85-1.00 inductive. RT6 connects capacitors in order to bring system's power factor to the adjusted value. The adjusted value is defined as $1.25 \times Q_{C1}$ value. Switching operation occurs out of this region.

N°03653496EN-AC

6.3 Adjustable Response And Reconnection Delay Time

Response delay time can be set between 10-1800 sec. Reconnection delay time can be set between 10-1800 sec.

Warning: Too short time can lead to damages to capacitors and contactors. If capacitors have no additional discharge devices, the reconnection delay must not be lower than 50 seconds. The selected delay time must not be shorter than the manufacturer's instruction.

The controller waits 50s by default for reconnection delay at startup and after step disconnection due to voltage micro cut.

6.4 Switching Program Selection

RT has 11 different program modes which determines the power ratio sequence of the capacitor steps:

- PS1 selection ==> 1: 1: 1: 1
- PS2 selection ==> 1: 1: 2: 2
- PS3 selection ==> 1: 2: 2: 2
- PS4 selection ==> 1: 2: 3: 3
- PS5 selection ==> 1: 2: 4: 4
- PS6 selection ==> 1: 1: 2: 4
- PS7 selection ==> 1: 2: 3: 4
- PS8 selection ==> 1: 2: 4: 8
- PS9 selection ==> 1: 1: 2: 3
- PSA selection ==> 1: 2: 3: 6
- PSb selection ==> linear

6.4.1 RT Capacitor Sequence Examples

The power ratio selection between capacitor steps is very important. The first step value will be the smallest one and the following steps must be the multiples of the first step.

Example: If the first capacitor power is 5 kVar, the capacitor power sequence of the following capacitors are as followed:

- PS1 selection ==> 5: 5: 5: 5
- PS2 selection ==> 5: 5: 10: 10
- PS3 selection ==> 5: 10: 10: 10
- PS4 selection ==> 5: 10: 15: 15
- PS5 selection ==> 5: 10: 20: 20
- PS6 selection ==> 5: 5: 10: 20
- PS7 selection ==> 5: 10: 15: 20
- PS8 selection ==> 5: 10: 20: 40
- PS9 selection ==> 5: 5: 10: 15
- PSA selection ==> 5: 10: 15: 30
- PSb selection ==> linear

Two different switching program is supported by RT :

a) Rotational Switching : This switching program is rotational between equal steps in the clockwise direction and this switching program is rotational to ensure that the capacitor switching cycles are uniformly distributed over all steps and to provide minimum switching steps for maximum service life time of the system. There are 8 different rotational switching program options (PS1, PS2, PS3, PS4, PS5, PS6, PS7, PS8, PS9, PSA).

b) Linear Operation : The switching program begins always from the first step to the last one in both switching on and off mode. The advantage of this switching program is the possibility of a large selection of capacitor steps conform to the step function ratio rule as explained above. The maximum possible ratio is "x:2x:4x:8x:16x...". This switching program is selected by PSb option.

6.5 Step Number Selection

By selecting the step number, the extra time spent connecting on/off the unused capacitor steps is eliminated. As a result, compensation system is used more effectively and efficiently. If step number is not selected, RT makes the compensation according to the factory set step number which is max. available output as defined on the front panel.

6.6 C/k Setting

The C/k value is a threshold value for switching on/off the capacitor steps. C/k is the value obtained by dividing first step capacitor power "C" to the Current Transformer Ratio "k". This value is measured and calculated by RT automatically or can be entered manually. After pressing the UP and DOWN buttons together, the C/k value is calculated and stored in one step switching on/off time interval. The further compensation controls are made with this stored value. In case of instantaneous change of the system's load, measuring process will be renewed. RT will stop the measuring after 10 attempts. It means that the C/k value couldn't be measured due to the instability of the system's load. In this case, compensation control will continue with the pre-stored value in the memory.

The formula to calculate the C/k value is :

$$C/k = \frac{Q}{k}$$

Q: Power of the first step capacitor (kvar)
k: Current Transformer Ratio.(CTR)

Example :

Let the power (C) of the first step capacitor is 5 kvar and the Current Transformer Ratio (k) is 100/5. Then the C/k value is:

$$C/k = 5/(100/5)=0.25$$

Examples of C/k value for the different C and k values are as followed :

CTR (k)	Power of Capacitor Step (kvar)											
	2.5	5	10	12.5	15	20	25	30	40	50	60	100
30/5	0.42	0.83										
50/5	0.25	0.50	1.00									
75/5	0.17	0.33	0.67	0.83	1.00							
100/5	0.13	0.25	0.50	0.63	0.75	1.00						
150/5	0.08	0.17	0.33	0.42	0.50	0.67	0.83	1.00				
200/5	0.06	0.13	0.25	0.31	0.38	0.50	0.63	0.75	1.00			
300/5	0.04	0.08	0.17	0.21	0.25	0.33	0.42	0.50	0.67	0.83	1.00	
400/5	0.03	0.06	0.13	0.16	0.19	0.25	0.31	0.38	0.50	0.63	0.75	
500/5		0.05	0.10	0.13	0.15	0.20	0.25	0.30	0.40	0.50	0.60	1.00
600/5			0.08	0.10	0.13	0.17	0.21	0.25	0.33	0.42	0.50	0.83
800/5			0.06	0.08	0.09	0.13	0.16	0.19	0.25	0.31	0.38	0.63
1000/5			0.05	0.06	0.08	0.10	0.13	0.15	0.20	0.25	0.30	0.50
1250/5				0.05	0.06	0.08	0.10	0.12	0.16	0.20	0.24	0.40
1500/5					0.05	0.07	0.08	0.10	0.13	0.17	0.20	0.33
2000/5						0.05	0.06	0.08	0.10	0.13	0.15	0.25
2500/5							0.05	0.06	0.08	0.10	0.12	0.20
3000/5								0.05	0.07	0.08	0.10	0.17
4000/5									0.05	0.06	0.08	0.13

6.7 Sensing the Energy Flow Direction

RT has four quadrant measuring and operation feature. So, RT is able to sense the energy flow direction and correcting itself for right compensation while calculating C/k value.

6.8 Current Transformer (CT) Selection

A CT (5 VA - secondary 5 A) located upstream from the capacitor bank and the loads must be used. The wires connecting CT to Power Factor Controller must be as short as possible and the diameter of wire not less than 2.5 mm². Since the current information is supplied by CT, the right selection of CT is very important. The secondary current of the selected CT must comply with the following current limits for correct measuring. Minimum=0.05mA, Maximum=5.5A (Minimum C/k Ratio must be 0.02)

7. ERROR DESCRIPTIONS

7.1 Wrong Cosφ

Current and Voltage phase connection are not correct.

7.2 Low Power Factor

The connection of the controller (CT location, phases of voltage supply) must be checked. The power value of the capacitor steps may decreased by time. The fuses which are connected to the capacitors may have been out of order. The power of the capacitor steps may have been insufficient to compensate the system. (In this case user must increase the capacitor power.)

7.3 Over Compensation

The connection of the controller (CT location, phases of voltage supply) must be checked. Over compensation may occur (especially at weekends, nights etc.) due to capacitive load current drawn by devices like ballasts, constant steps, etc. The contactor's contacts switching the capacitor steps may have stuck to each other due to the instantaneous over current. Unnecessary capacitor steps may have switched on manually.

8. EASY INSTALLATION RECOMMENDATION (IMPORTANT NOTICE)

When the load is unstable and varies very quickly, the C/k calculation process may take long time or in some cases it can not be calculated properly or miscalculated which may cause improper compensation. A practical way to prevent this situation is as followed:

1- Turn on the compensation board without connecting the load current. Only the capacitors will be in operation in this situation. (You can do this by switching off the load current temporarily)

2- Start the C/k calculation process by pressing the UP and DOWN buttons at the same time. Now, depending on the power of the first step, C/k value is calculated very accurately by RT. The calculated C/k value will automatically be stored in the memory. You can switch the load on. This C/k value will be kept in the memory until it is recalculated or changed manually.

9. TECHNICAL SPECIFICATIONS

- Rated Voltage (Un) : 185...265 V AC or 320...460 V AC
- Operating Current Range(ΔI) : 50 mA-5.5A
- Frequency : 50 Hz / 60 Hz +/-2 Hz
- Measuring Class : 1% ±1digit (V,I,cosφ), 2% ±1digit(W,var,VA)
- Power Consumption : Current : <2 VA
Voltage : 3 VA - 10 VA
- Output Contact : 3A / 250V - 1A / 400V
- Protection in case of micro cuts in voltage : 20 msec. < 30 % of nominal voltage
- Setting Range: Manual C/k Setting : 0.02-1.0
Cosφ Setting:0.85 (ind.)-1.00
CT Ratio:5-10000
- Response Delay Time : Between 10 sec.-1800 sec.
- Reconnection Delay Time : Between 10 sec.-1800 sec.
- Over Voltage Values : Programmable,
240 - 275 V AC (for 185 ... 265 V AC)
410 - 480 V AC (for 320 ... 460 V AC)
- Number of Steps : max. 12
- Ambient Temperature : 0°C - 55°C
- Display : 4 Digits ,Red Display
- Equipment Protection Class : Double Insulation-Class II (□)
- Wire Section (For Terminal Block) : 2.5 mm²
- Standard : EMC - IEC 61326 - IEC 61000-6-2, IEC 61000-6-4
Safety - EN 61010-1
- Enclosure Material : ABS UL 94 V0
- Protection Class : IP 41 (Front face), IP 20 (Rear face) acc. to IEC 60 529
- Shock Test : IK 06
- Connections (the "C" terminal blocks are short-circuited inside the controller.) : Socket terminals with screw
- Switchboard cut-out : 139x139 mm
- Weight : 0.8 kg.

10. FACTORY SET VALUES

- Target Cosφ : 1.00 (ind.)
- Response delay : 10 sec.
- Reconnection delay : 50 sec.
- Nb steps : 6, 8
- Program : PS1
- C/k : 0.5
- CT Ratio : 5
- Over Voltage protection : ON
- Over Voltage Setting : 265 V (for 185.....265 V AC)
460 V (for 320.....460 V AC)

11. DIMENSIONS

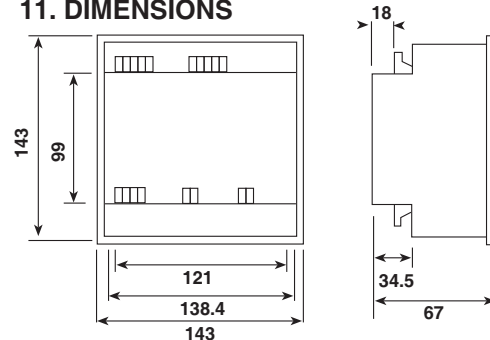

Schneider Electric Industries SAS

399 rue de la Gare
74370 Pringy
France
Tél. : 33 (0)4 50 66 95 00
Fax : 33 (0)4 50 27 24 19
<http://www.schneider-electric.com>

As standards, specifications and designs change from time to time, please ask for confirmation of the information given in this publication