

ION[®] 8800



User Guide



**POWER
MEASUREMENT**

drive energy performance™

www.pwr.com

Notices

For further assistance
please contact us at:

Power Measurement
2195 Keating Cross Road
Saanichton, BC
Canada V8M 2A5
Tel: 1-250-652-7100
Fax: 1-250-652-0411

www.pwr.com

© 2006 Power Measurement
Printed in Canada
Revision Date: June 26, 2006
70000-0285-00

Danger



This symbol indicates the presence of dangerous voltage within and outside the product enclosure that may constitute a risk of electric shock, serious injury or death to persons if proper precautions are not followed.

Caution



This symbol alerts the user to the presence of hazards that may cause minor or moderate injury to persons, damage to property or damage to the device itself, if proper precautions are not followed.

Note



This symbol directs the user's attention to important installation, operating and maintenance instructions.

Installation Considerations

Installation and maintenance of the ION 8800 meter should only be performed by qualified, competent personnel that have appropriate training and experience with high voltage and current devices. The meter must be installed in accordance with all local and national electrical codes.

If this equipment is used in a manner not specified by the manufacturer, the protection from electric shock, fire, etc. provided by this equipment may be impaired.

DANGER

Failure to observe the following instructions may result in severe injury or death.

- ◆ During normal operation of the ION 8800 meter, hazardous voltages are present on its connector pins, and throughout the connected potential transformer (PT), current transformer (CT), direct connect without PTs, digital (status) input, control power and external I/O circuits. PT and CT secondary circuits are capable of generating lethal voltages and currents with their primary circuit energized. Follow standard safety precautions while performing any installation or service work (i.e. removing PT fuses, shorting CT secondaries, etc).
- ◆ Do not use digital output devices for primary protection functions. These include applications where the devices perform energy limiting functions or provide protection of people from injury. Do not use the ION 8800 in situations where failure of the devices can cause injury or death, or cause sufficient energy to be released that can start a fire. The meter can be used for secondary protection functions.

- ◆ The ION 8800 meter's chassis ground must be properly connected to a good earth ground for safety, and for the noise and surge protection circuitry to function correctly. Failure to do so will void the warranty, and create a risk of electric shock, injury or death.
- ◆ When installing the meter, all voltage paths (measurement voltage and all auxiliary circuits such as the power supply and the tariff control voltage) must be fused according to applicable local safety standards.

CAUTION

Observe the following instructions, or permanent damage to the meter may occur.

- ◆ The ION 8800 meter offers a range of hardware options that affect input ratings. The ION 8800 meter's serial number label lists all equipped options. Applying current levels incompatible with the current inputs will permanently damage the meter. This document provides installation instructions applicable to each hardware option.
- ◆ Do not HIPOT/Dielectric test the digital (status) inputs, digital outputs, power supply terminals or communications terminals. Refer to the label on the ION 8800 meter for the maximum voltage level the device can withstand.
- ◆ Replacing the meter battery with the wrong type or voltage rating could result in damage to the meter. Use only a lithium LiSOCl₂ battery with a rated voltage of 3.6 V, and the same construction as the original battery, as a replacement.

Network Compatibility Notice for the Internal Modem

The internal modem in meters equipped with this option is compatible with the telephone systems of most countries in the world. Use in some countries may require modification of the internal modem's initialization strings. If problems using the modem on your phone system occur, please contact Power Measurement Technical Support.

Standards Compliance



Made by Power Measurement Ltd.

Limitation of Liability

Power Measurement reserves the right to make changes in the device or its specifications identified in this document without notice. Power Measurement advises customers to obtain the latest version of the device specifications before placing orders to verify that the information being relied upon by the customer is current.

Regardless of whether any remedy set forth herein fails of its essential purpose, except to the extent the following limitation is prohibited by applicable law, Power Measurement shall not, in any event or under any legal claim or theory (whether based on contract, indemnity, warranty, tort (including negligence and strict liability) or otherwise), be liable to the original purchaser or any other person or entity for special, indirect, incidental, punitive, liquidated, special or consequential damages whatsoever with respect to any purchased product, including, without limitation, business interruption, loss of use, profit or revenue, even if Power Measurement has been advised of the possibility of such damages. To the extent that a limitation or exclusion of consequential damages are prohibited by applicable law, then Power Measurement's liability shall be limited to twice the amount of the relevant purchased product.

The information contained in this document is believed to be accurate at the time of publication, however, Power Measurement assumes no responsibility for any errors which may appear here and reserves the right to make changes without notice.

For product or service warranty information, please refer to the applicable "Power Measurement Terms and Conditions of Sale - Equipment" or "Power Measurement Terms and Conditions of Sale - Services" at the following internet address:

<http://www.pwrm.com/buy/terms/>

PowerLogic, ION, ION Enterprise, MeterM@il and Modbus are either trademarks or registered trademarks of Schneider Electric. All other trademarks are property of their respective owners.

Covered by one or more of the following patents:

U.S. Patent No's 7010438, 7006934, 6990395, 6988182, 6988025, 6983211, 6961641, 6957158, 6944555, 6871150, 6853978, 6825776, 6813571, 6798191, 6798190, 6792364, 6792337, 6751562, 6745138, 6737855, 6694270, 6687627, 6671654, 6671635, 6615147, 6611922, 6611773, 6563697, 6493644, 6397155, 6236949, 6186842, 6185508, 6000034, 5995911, 5828576, 5736847, 5650936, D505087, D459259, D458863, D443541, D439535, D435471, D432934, D429655, D427533.

Table of Contents

Chapter 1	Introduction	9
Chapter 2	Front Panel	21
Chapter 3	Templates and Firmware	37
Chapter 4	Basic Setup	43
Chapter 5	Security	47
Chapter 6	Communications	69
Chapter 7	Third-party Protocols	89
Chapter 8	Time	115
Chapter 9	Demand	121
Chapter 10	Inputs / Outputs	129
Chapter 11	Energy Pulsing	137
Chapter 12	Logging	143
Chapter 13	Revenue	155
Chapter 14	Power Quality	165
Chapter 15	Displays	169
Chapter 16	TEST Mode	181
Chapter 17	Resets	189
Chapter 18	Alerting	195
Chapter 19	Setpoints	201
Chapter 20	Power Availability	205
Chapter 21	Reports	213
Chapter 22	Verifying Accuracy	217

Chapter
1

Introduction

This manual discusses ION 8800 meter features and provides configuration instructions.

By the time you are ready to use this guide, your meter should be installed, most basic setup should have been performed, and communications/basic operation should have been verified. If the unit is not yet installed and operational, refer to the Installation Guide shipped with the meter.

This chapter provides an overview of ION 8800 meters, and summarizes many of their key features.

In This Chapter

◆ ION 8800 Meters	10
The ION meter in an Enterprise Energy Management System	11
◆ Meter Features	12
Measured Parameters	12
Rack-mount Installation	13
Data Display and Analysis Tools	14
Supported Protocols	14
Communications Options	15
I/O Options	15
ION Enterprise Software Support	16
ION Setup Software Support	17
ION EEM Software Support	17
◆ Using this Guide	18
◆ Getting More Information	20

ION 8800 Meters



The ION 8800

ION 8800 intelligent metering and control devices provide revenue-accurate, true RMS measurements of voltage, current, power and energy, and are complemented by extensive I/O capabilities, comprehensive logging, and advanced power quality measurement and compliance verification functions. The meters come with an extensive selection of pre-configured data screens and measurements, so you can use the meters “out of the box” or customize them to fit your unique requirements.

ION 8800 meters can replace numerous transducers, traditional meters, and control circuits. You can integrate the meters with ION[®] software or other energy management, SCADA, automation and billing systems, using multiple industry-standard communication channels and protocols.

Common Meter Applications

- ◆ Transmission and distribution metering
- ◆ Revenue and tariff metering
- ◆ Power quality compliance monitoring
- ◆ Power quality analysis
- ◆ Load management
- ◆ System stability monitoring
- ◆ Energy pulsing and totalization
- ◆ Instrument transformer calculation
- ◆ Transformer \line loss calculation
- ◆ Real-time system loss measurements

The ION meter in an Enterprise Energy Management System

You can use ION 8800 meters as standalone devices, but their extensive capabilities are fully realized when used with ION software as part of an enterprise energy management (EEM) system.

EEM systems give energy suppliers, service providers, and large industrial and commercial energy consumers the tools to meet all the challenges and opportunities of the new energy environment. EEM systems use real-time information and control to directly address a broad range of requirements throughout the power delivery chain and across an entire enterprise. These systems offer an integrated solution to managing new billing structures, distributed generation, energy purchasing, energy cost control, operational efficiency, and power quality and reliability.

Applications that include the meter typically require additional equipment. Display and analysis software tools are almost always used to manage, interpret and distribute the data measured or logged by a meter. There are usually a variety of tools used, and often these tools are connected using different communications standards and protocols. In many cases, a meter must also provide control capabilities and device-level data sharing.

The meter can adapt to many situations. Advanced communications allow data to be shared simultaneously across multiple networks, built-in I/O provides monitoring and control capabilities, and a variety of display and analysis tools to help you get the most from your power system.

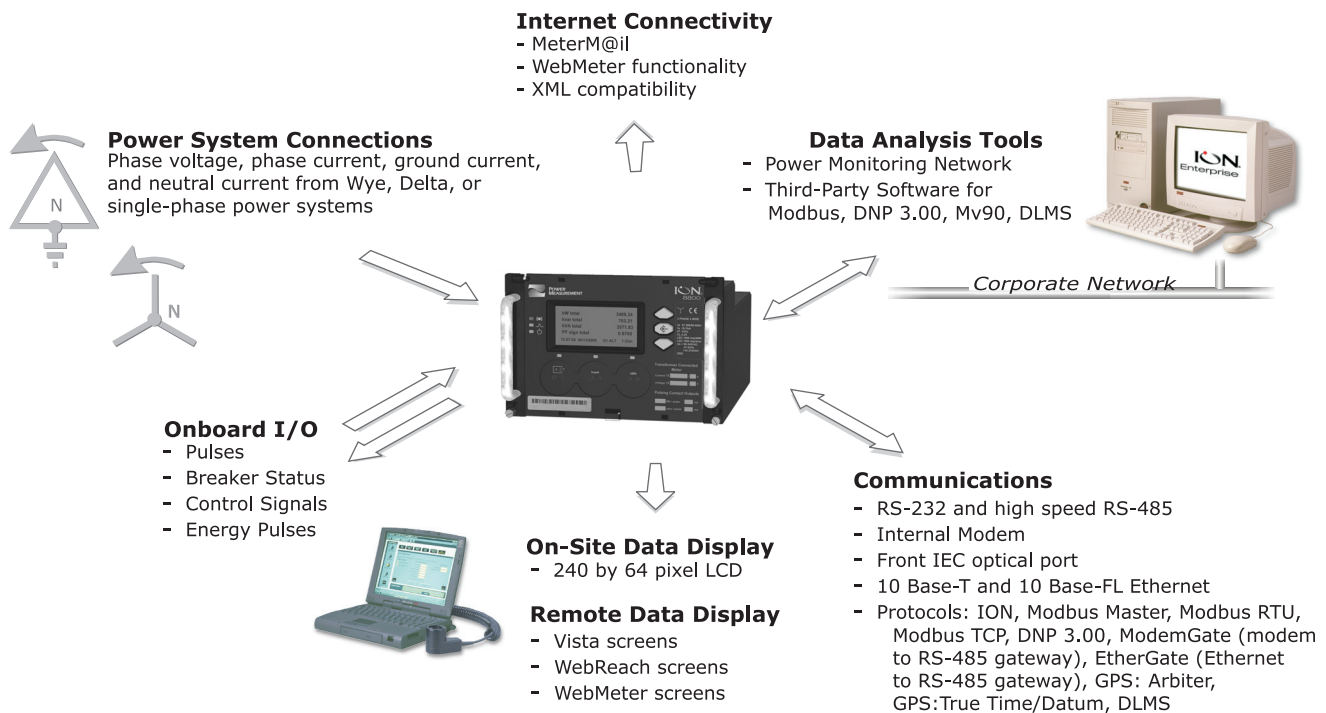

Meter Features

The ION 8800 offers three base models: ION 8800A, ION 8800B, and ION 8800C.

- ◆ Feature Set C -- Energy/tariff meter
- ◆ Feature Set B -- Feature Set C + EN50160 compliant power quality monitoring
- ◆ Feature Set A -- Feature Set B + power quality analysis (waveforms and transient capture with 1024 samples/cycle resolution)

Measured Parameters

All ION 8800 meters provide fully bi-directional, 4-quadrant, revenue-accurate or revenue-certified energy metering. The following is a selection of some parameters measured by these meters.

Energy

The meters provide all common active, reactive and apparent energy parameters.

- ◆ kWh delivered and received
- ◆ kWh, kvarh, kVAh net (delivered - received)
- ◆ kWh, kvarh, kVAh total (delivered + received)
- ◆ kvarh, kVAh delivered and received
- ◆ Volt-hours and amp-hours
- ◆ Integration of any instantaneous measurement

Energy registers can be logged automatically on a programmed schedule.

All energy parameters represent the total for all three phases. Energy readings are true RMS. Maximum range of energy readings is 999,999,999. Beyond this value, readings roll over to zero (0).

Demand

The meters support all standard demand calculation methods, including block, rolling block, and predicted demand. They can measure demand on any instantaneous value and record peak (maximum) and minimum demand with date and time-stamps to the second. Peak demand registers can be reset manually (password protected) or logged and reset automatically on a programmed schedule. Measurements include:

- ◆ kW, kvar, kVA demand, min/max
- ◆ Amps, Volts demand, min/max
- ◆ Demand on any instantaneous measurement

Instantaneous

ION 8800 meters provide a choice of high-accuracy 1 second, or high-speed 1/2 cycle measurements, including true RMS, per phase and total for:

- ◆ Voltage and current
- ◆ Active power (kW) and reactive power (kvar)
- ◆ Apparent power (kVA)
- ◆ Power factor and frequency
- ◆ Voltage and current unbalance
- ◆ Phase reversal

Harmonics

The meter offers complete harmonic distortion metering, recording and real-time reporting, up to the 63rd harmonic for all voltage and current inputs.

- ◆ Individual harmonics (including magnitude, phase and inter-harmonics for the ION 8800A meter)
- ◆ Total even and odd harmonics
- ◆ K-factor, Crest factor

Min/Max Recording

The meters record each new minimum and new maximum value with date and time-stamp for the following parameters:

- ◆ Voltage and current min/max
- ◆ kW, kvar, and kVA min/max
- ◆ Power factor
- ◆ Frequency
- ◆ Voltage unbalance
- ◆ Plus any measured value

Rack-mount Installation

The ION 8800 meter easily installs into new or existing IEC/DIN 43862 19" racks. The meter's rear Essailec® connectors provide common voltage and current measurements and energy pulsing pin-outs for reduced installation costs.

Data Display and Analysis Tools

Display and analyze meter data with a wide variety of tools.

The Front Panel

Use the meter's front panel interface for local monitoring and standalone applications. The bright LCD display lets you view real-time values and perform basic device configuration. The front panel is often used in combination with an ION software system, providing an interface for field personnel.

WebMeter[®] Embedded Web Server Feature

Ethernet-equipped meters include WebMeter functionality -- an on-board web server that provides quick and easy access to real-time energy and basic power quality information without special software. The meter's built-in web pages display a range of energy and basic power quality information via an Ethernet connection, and support basic meter configuration tasks.

MeterM@il[®] Internal E-Mail Client Feature

Configure the meter to automatically email high-priority alarm notifications or scheduled system-status update messages to anyone, anywhere within the facility or around the world. Specify the type of event that triggers an email alert, such as power quality disturbances or logged data at any pre-determined interval, and have your ION software administrator program the meter to respond with a MeterM@il message when these events occur. MeterM@il messages are received like any email message by a workstation, cell phone, pager, or PDA.

XML Compatibility

Your meter can exchange information using industry-standard XML format. This simple machine-readable format supports easy integration with custom reporting, spreadsheets, databases, and other applications.

Supported Protocols

You can integrate the meter into various industry-standard networks. Measured meter data can be made available to other devices using Modbus RTU, Modbus/TCP, DLMS and DNP 3.0 protocols, as well as the Itron MV-90 revenue billing system. You can also configure the meter to import and log data from other devices on these networks. With these advanced communications functions, the power of the meter can be utilized in most existing power monitoring systems. Any data display and analysis software that works with Modbus RTU or DNP 3.0 devices also functions with the meter.

Communications Options

The standard meter includes an IEC 1107 front optical port for communications in the field. Ordering options include a Communications Module which offers a high-speed RS-485 port, a selectable RS-232/RS-485 port, a 10Base-T Ethernet port or 10Base-FL fiber-optic port, and a 56 kbps internal modem. Depending on the hardware options purchased, up to five separate ports can communicate simultaneously.

NOTE

The communications module is retrofittable – it can be installed or replaced while the meter is in the field.

I/O Options

The meter's digital inputs and outputs connect to the Essailec connector on the back of the meter. Two different I/O configurations are available, each providing different capabilities. Additionally, two infrared ports (and corresponding LEDs) on the front panel are configured by default for energy pulsing.

Digital Inputs

The meter can be ordered with externally-excited digital inputs capable of detecting a pulse rate of 20 pulses/second and timestamping transitions with 1 ms resolution. They can be used for tariff inputs or other pulse counting applications.

Relay Outputs

The meter can be ordered with both Form C and Form A solid-state outputs; one mechanical Form C relay is standard on all meters. The solid-state outputs have a maximum voltage rating of 250 VDC, 210 VAC or 300 volts peak and 100 mA AC/DC. The mechanical relays are rated at 250 VAC / 125 VDC and can switch up to 1 A loads.

ION Enterprise Software Support

The complete ION Enterprise software package integrates the meter into a fully networked information system with other meters and local and wide-area computer networks. ION Enterprise is recommended for all power monitoring systems where advanced analysis and control capabilities are required.

ION Enterprise provides tools for managing your power monitoring network, logging data, analyzing real-time and logged data, generating power system reports, and creating custom functionality at the meter level.

Vista

Vista presents a graphical view of your power system, allowing you to view and analyze real-time data from power meters and historical data from the ION database. Vista reports on the status of your system components, informing you of alarm conditions and providing you with control capabilities for initiating intelligent device functions or actuating field machinery. Vista includes sophisticated tools for analyzing real-time and logged power data and system events.

For more information, refer to the Vista section in the online *ION Enterprise Help*.

WebReach (online Vista)

The WebReach component of ION Enterprise adds thin-client support functionality to the ION Enterprise software. With the WebReach feature you can use the web browser from any machine on your network to view the Vista diagrams of all the meters on your network, regardless of whether they are located locally or across the country. You can create custom screens in Vista for display in your web browser, including real-time numeric data, background graphics or diagrams, and basic views of event, data and waveform logs.

Reporter

Reporter lets you define and create comprehensive database reports using Microsoft Excel. Configured Power Quality, Load Profile, Energy and Demand, and EN50160 reports are included with Reporter.

For more information, refer to the Reporter section in the online *ION Enterprise Help*.

Management Console

Management Console is used to build your ION Enterprise power-monitoring network to reflect the way the physical communications network is wired, so ION Enterprise software can communicate with your devices. The network is created using sites, servers, modems, and intelligent devices that can be added, removed, configured, or duplicated.

You can access the following tools from the Management Console menus:

- ◆ **Diagnostics Viewer** is the primary source of troubleshooting information in ION Enterprise.
- ◆ **Device Upgrader** lets you upgrade the operating software inside an ION meter.
- ◆ **Remote Modem Setup** lets you set up modems for remote sites.
- ◆ **Database Manager** lets you manage your ION Enterprise databases with both manual tasks and scheduled tasks.
- ◆ **User Manager** lets you configure ION Enterprise software user accounts that define different operations permitted within the ION software, such as viewing meter data, performing control actions, or configuring the meters.
- ◆ **License Manager** lets you upgrade the number of devices you can have without re-installing the software.

For more information, refer to the Management Console section in the online *ION Enterprise Help*.

Designer

Use Designer to customize the operation of hardware nodes, such as ION meters, and software nodes, such as the ION Virtual Processor, the Log Inserter, and the Query Server. Designer uses a WYSIWYG graphical user interface to pictorially represent a node's configuration (i.e., how the different ION modules are linked together in a framework). In addition to giving you the ability to change the settings of any ION module, Designer also lets you change existing links between modules, add new links, add new modules or delete modules. Designer helps you visualize the logic when you are programming custom functionality in an ION device.

For more information, refer to the Designer section in the online *ION Enterprise Help*.

ION Setup Software Support

ION Setup is a software tool designed specifically to configure and test meters. ION Setup offers an intuitive graphical interface for performing basic meter setup, installing templates into meters, viewing real-time and resetting accumulated values, verifying meter calibration and measurements, and setting up advanced security. Versions 2.1 and later support ION 8800 meters.

ION EEM Software Support

ION EEM is web-based software that gathers, cleanses, and integrates real-time and archived data - from new or legacy meters, weather service feeds, real-time pricing, and other sources - and translates it into precise and actionable information via a fully accessible dashboard. It enables organization-wide collaboration by offering custom information to decision makers, planners, and front line staff: analysis and reporting tools, real-time monitoring, and alerting capabilities.

Using this Guide

This User Guide is directed at three types of user: the typical user or operator, the system administrator, and the advanced user. You might not fit into any of these groups directly, or perhaps you are both an operator and an administrator. These classifications are intended to make this guide easier to navigate with respect to which information is appropriate to your needs.

Typical User or Operator

Most users simply want to display the data provided by the factory-configured meter. These users want fast access to data through the front panel, ION software, or a third-party protocol such as Modbus or DNP.

System Administrator or Manager

Some users need to make minor adjustments so that their meters “fit” their power systems: data recording intervals, demand sub-intervals and other parameters may need to be set before the meter’s setup is complete. These users will use the front panel, or ION software to change settings in the device’s operating software (ION Enterprise is highly recommended.)

Advanced User or Systems Integrator

Advanced users may want to make use of the flexibility and power provided by the meter’s operating software. These users will need to become familiar with the ION architecture, and the ION software tools used to customize the device’s operation.

Symbols

The following symbols are used in this manual to warn you about the risk of injury, damage to the equipment, inconvenience if the proper procedure is not followed, or additional information you may want to consider.

CAUTION

This symbol alerts you to things that may cause loss of data, damage to your computer or your device.

DANGER

This symbol alerts you to things that may cause serious injury to a person. Only qualified, properly trained personnel should perform these procedures.

NOTE

A note provides you with additional information that you might want to consider.

TIP

This symbol draws your attention to information that will help you perform a task more quickly or easily.

Terminology

- Clear:** Place the mouse cursor over the check box for the specified option, then click the mouse button so that the check mark is removed from the check box.
- Click:** Place the mouse cursor over the specified option or button, then press and release the mouse button.
- Double-click:** Place the mouse cursor over the specified option or button, then press and release the mouse button twice.
- Drag:** Hold down the mouse button while moving the mouse cursor to the appropriate location, then release the button.
- Enter:** Type the information, then press the ENTER or RETURN key.
- Point:** Position the mouse pointer over a submenu or menu command. For example, point to the File menu.
- Press:** Press the specified key or key combination on your keyboard, for example, press CTRL+ALT+DEL.
- Select:** Place the mouse pointer over the check box for the specified option, then click the mouse button so that an X or check mark appears in the check box.
- Or
- Place the mouse pointer over the specified box or button, then click the mouse button.
- Type:** Type the information. Do not press the Enter or Return key.

PDF Documents

This manual is also provided in PDF (Portable Document Format) at our website: www.pwrm.com

Use Acrobat Reader to view and print the PDF version of the manual. When printing the manual, please print the entire manual, including the copyright and disclaimer statements.

The PDF files for all Power Measurement products are available from the Power Measurement web site. Each Power Measurement device has installation information and a user guide to teach you about the features of your device.

ION meters are programmed using ION modules that are linked to create unlimited custom functionality. Your meter has many pre-configured modules that provide most functionality that you need. If you want to extend or customize the functionality of your meter consult the online *ION Reference* for general information and ION module descriptions. For information on configuring specific meter features, search the technical notes.

Getting More Information

Additional information is available from Power Measurement:

- ◆ visit our web site at www.pwrm.com
- ◆ contact your local Power Measurement representative
- ◆ contact Power Measurement directly

Documents that are related to the installation, operation and application of the meter are as follows:

ION 8800 Installation Guide

This brief manual is shipped with each meter. It details the mounting, wiring and basic setup of the device.

ION Reference

The ION Reference describes ION architecture (the common software architecture in all ION devices) and provides an explanation for each of the ION modules.

Online ION Enterprise Help & Online ION Setup Help

In-depth online help systems for ION Enterprise and ION Setup software.

Technical Notes

Technical notes provide instructions for using meter features and for creating custom configurations.

Product Option Documents

These documents include instructions on how to retrofit your current product with your new option, and how to utilize the option.

Protocol Documents

Each protocol document contains information explaining how our products interact with a protocol, such as DNP 3.0, DLMS, Modicon Modbus, and MV-90.

Chapter
2

Front Panel

The front panel of the ION 8800 provides a user-friendly interface from which you can view system data or configure meter settings. A scrollable display and three distinct modes (NORM, ALT and TEST) provide easy access to a full range of functions through a simple three-button keypad.

Another set of buttons, protected under a sealable cover provides advanced functionality.

This chapter describes the front panel and explains how to use it to display data, perform tests, and set up basic configuration options.

In This Chapter

◆ Front Panel Features	22
◆ Display Screen Types	26
◆ Modes of Operation	29
◆ Configuring the Meter with the Front Panel	31
Setup Menus	32

Front Panel Features

The front panel of the ION 8800 includes:

- ◆ a liquid crystal display with detailed graphics and text
- ◆ navigation buttons to move from screen to screen, and for basic setup procedures
- ◆ operational LEDs to indicate meter conditions
- ◆ energy pulser ports and LEDs to aid in meter testing
- ◆ IEC 1107 optical serial port
- ◆ protected (sealable) buttons for advanced meter configuration

This section outlines the features available on the front panel of the meter.

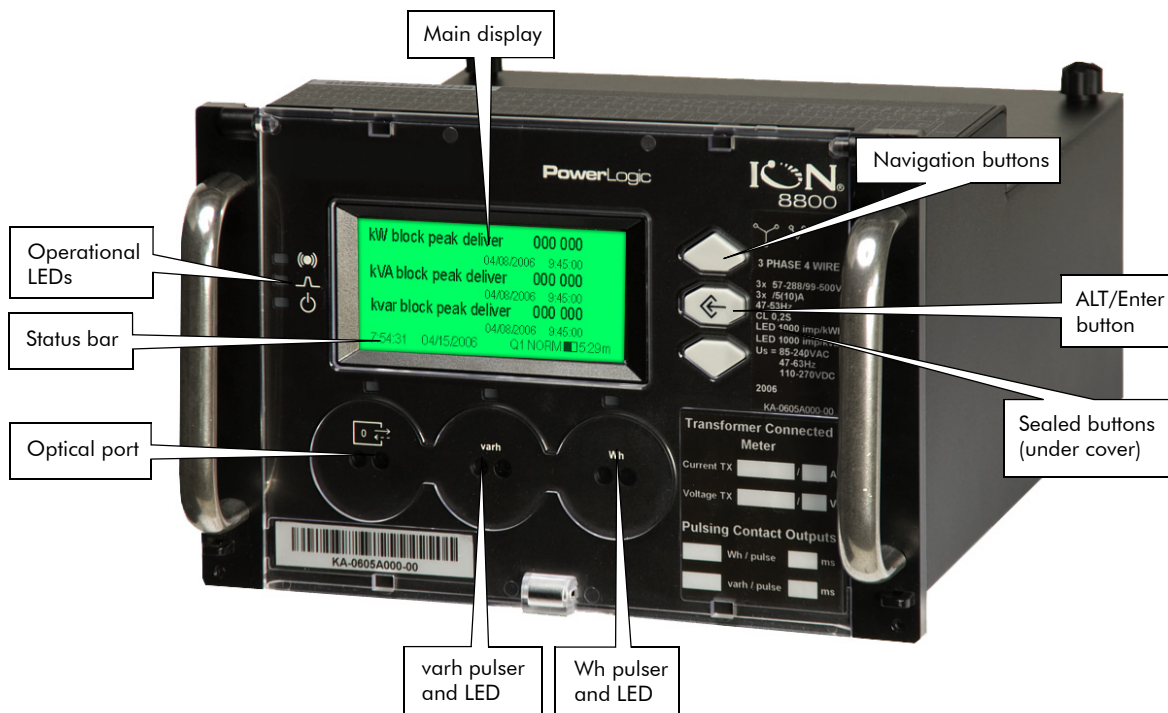

Meter display

The meter's display shows numeric data screens, event logs, phasor diagrams, bar graphs and harmonics histograms. As the graphic above illustrates, the display screen is divided into two sections: the main display area and the status bar.

The main display area presents meter data, while the status bar provides time, date, phase, quadrant, and mode information. During normal operation, the main display area automatically cycles through a series of several displays. If you prefer, you can use the Up or Down arrow buttons to step manually through these displays. By default, the automatic scrolling will resume 60 seconds after you have last pressed a button.

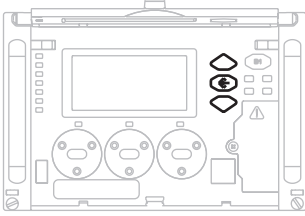

Navigation buttons

The navigation buttons are the **Up** and **Down** arrow buttons and the round **Alt/Enter** button. Pressing the **Up** or **Down** arrow buttons to manually scroll back or forth through the available displays temporarily halts the display screen's automatic scrolling function. Pressing **Alt/Enter** toggles between NORM and ALT display modes. The automatic scrolling function restarts 60 seconds after a button was last pressed.

Hold the **Alt/Enter** button for approximately three seconds to display the Setup menu. You can then use the navigation buttons to view the device's configuration or edit communication settings. See "Setup Menus" on page 32 for further instruction on modifying the device's configuration using the front panel buttons.

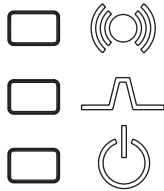

Operational LEDs

Three operational LEDs are located to the left of the display screen.

Alarm (top): The alarm output flashes to alert maintenance personnel should any internal diagnostic errors occur. Contact Technical Support if this happens.

Indicator (middle): This LED is user programmable and is not linked by default.

Power (bottom): This LED indicates the meter is powered. The light should always remain on when the meter is in service.

Energy pulser ports and LEDs

Two red LED pulsers located below the front panel display represent Wh - to the right - and varh - in the middle. On the left is the optical port.

These LEDs are preconfigured for energy pulsing. Located directly beneath each LED is an infrared output, which is connected to the LED and pulses at the same rate. Pulse rates can be adjusted by re-configuring the Calibration Pulser module; for a detailed description of LED pulsers operation, refer to "Energy Pulsing with Infrared Ports and LEDs" on page 141).

Optical port and LED

An optical port facilitates infrared communication with the device. For details on how to configure and use this port, see "Optical Port Connections (COM1)" on page 72.

A green LED pulser, located above the optical port, flashes to indicate communications activity on the port.

The following protected buttons can only be accessed when the meter cover is open:

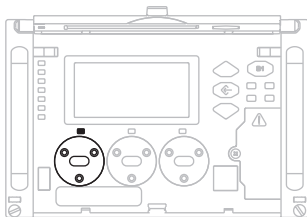
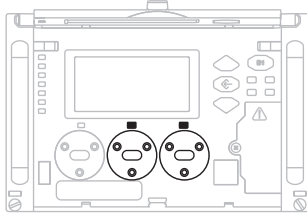

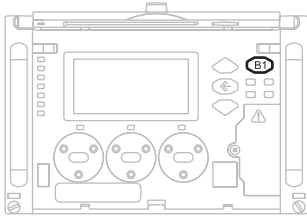

Demand reset button (B1)

The recessed Demand Reset button resets the peak demand values logged in the meter. When the meter is in TEST mode, the Demand Reset button resets the test demand parameters.

The ION setup register labeled Demand Lockout Time sets the minimum time allowed between consecutive demand resets; the meter ignores any attempts to reset the demand outside the bounds of the register. The default value for the Demand Lockout time is 25 days. For details on the Demand Lockout Time setup register, refer to “Demand and Peak Demand Module Overview” on page 124.

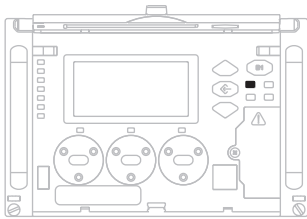

TEST Mode button (B2)

The recessed TEST Mode button is located under the meter's front cover; it places the meter into TEST mode. While in TEST mode, the meter ceases accumulation of billable quantities; energy and demand measurements are accumulated in TEST mode registers.

Refer to “TEST Mode” on page 30 for more details on this mode of operation. Billable quantities do not accumulate when the meter is in TEST mode.

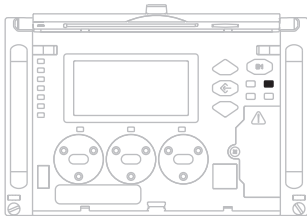

ALT Config button (B3)

The recessed ALT Config button is located under the meter's front cover; press this button to access the Alternate Configuration menu.

Use the Alternate Configuration menu to control setup access via the front optical port, lock and unlock the meter, and clear alarms.

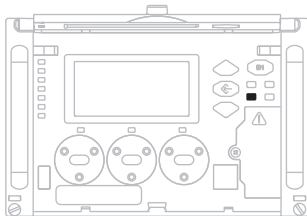

Master Reset button (B4)

The recessed Master Reset button is located under the meter's front cover; it resets meter values. Use the Master Reset button to delete most accumulated values and all derived revenue measurements from the meter.

To use the Master Reset button:

1. Open the meter front cover.
2. Using a pen or similar instrument, press the **Master Reset** button.
3. At the confirmation screen, select Yes to confirm the reset.

CAUTION

After initiating a Master Reset, wait until the “Master Reset Completed” message appears on the front panel (or about two minutes, depending on your firmware). This allows the meter to completely reset parameters. This is especially important if you are powering down the meter after a Master Reset.

Hardware-Locked Meters and Master Reset

Master reset is not accessible via software in a hardware-locked ION 8800 meter. To perform a master reset on a hardware-locked meter:

1. Unlock the meter via the ALT Config menu.
2. Open the meter's front cover and press the **Master Reset** button.

On hardware-unlocked meters, you can perform a Master Reset via software.

Parameters affected by a Master Reset

The Master Reset button resets many of the device's measurements and logs.

The following parameters are reset to zero:

- ◆ Energy and Demand
- ◆ Peak Demand
- ◆ Loss Calculation
- ◆ Power Quality disturbance counters
- ◆ Time of Use

The following are cleared:

- ◆ Event Log
- ◆ All Data Recorders
- ◆ All Waveform Recorders

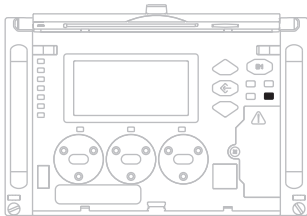

Spare button (B5)

This button is currently not used.

Display Screen Types

The front panel displays measurements, configured settings and configuration data in a variety of forms. The types of display screens are described below. For information on customizing the display on your meter, see “Configuring Front Panel Displays” on page 171.

The status bar

The status bar runs along the bottom of the front panel display and contains information about the following settings:

- ◆ Date and time.
- ◆ Voltage phases present. The labels and rotation of phases correspond to the configuration of the power monitoring system. 12 31 is for Delta configuration and 123 is four wire Wye configurations.
- ◆ Quadrant where the system power factor resides.
- ◆ Mode (NORM, ALT or TEST).
- ◆ Time remaining in the Rolling Block Demand interval. If the interval has counted to zero the letters **EOI** (End Of Interval) appear on the status bar. If the interval is counting down then a time remaining indicator appears.



Numeric displays

All NORM mode data and some of the ALT mode display screens use numeric displays. Numeric displays show up to four parameters at a time. If no numeric values are available for a parameter, N/A is displayed.

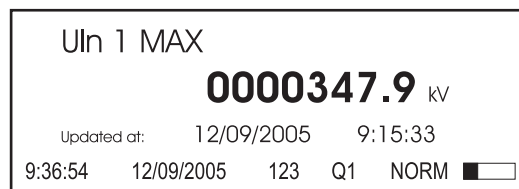

The front panel automatically scales the units for basic measurements (i.e. voltage, current and power parameters). For example, a measurement of 2,000 Watts is displayed as 2 kW. A measurement of 2,000,000 Watts is displayed as 2 MW. The meter makes these conversions using your PT and CT Ratios.

Nameplate display and event log

Nameplate displays and event logs appear in ALT mode and are organized in tabular format. Nameplate displays show owner, meter and power system details:

OWNER	Best Utility		
TAG 1	Substation 13A		
TAG 2	Main Feed 13kV		
FW Rev, FEATURE SET	8800V310, A		
BATTERY LIFE 96.9%	DIAG NUM	40/999	
15:36:54	12/09/2005	Q1 ALT	<input type="checkbox"/> 3:39m

The Event Log displays recent high priority events. You must use ION software to retrieve all logged data:

DATE	TIME	EVENT	CODE
12/08/2005	10:23:45	Shutdown	SD25
12/08/2005	10:42:03	Power Up	SD25
12/08/2005	11:19:26	Changed Setup	SD25
VIEW EVENT LOG THROUGH COMMUNICATIONS			
9:36:54	12/09/2005	123	Q1 NORM <input type="checkbox"/>

Histogram displays

Harmonic content is displayed in histogram format. The 2nd to the 63rd harmonics are displayed in the histogram. The total harmonic distortion (THD) is displayed above the histogram.

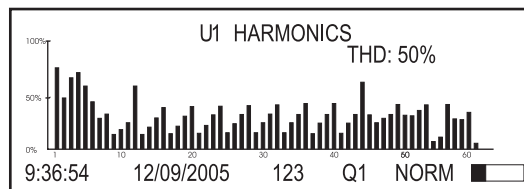

Phasor diagram displays

Phase information can be displayed in phasor diagram format. Phasor diagrams are accompanied by tables that show phase, voltage and current magnitudes. In cases where a phase vector is too small to be represented graphically, it is shown as a table entry only.

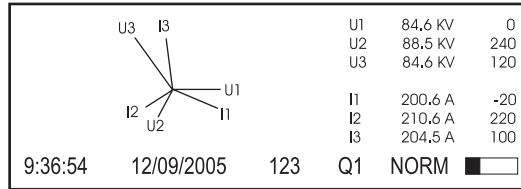

Disk simulator

This display simulates the behavior of a mechanical watt-hour meter indicating power received or delivered by the direction of the pulse.

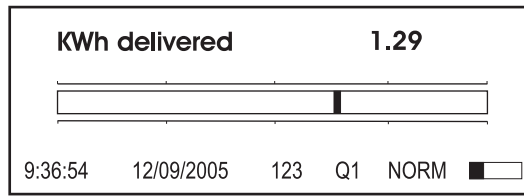

Time and date

This displays supports time and date formats, enabling displays with nothing but date and/or time and/or time remaining in the current interval.

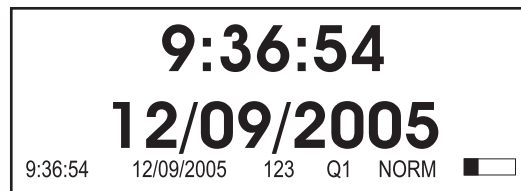

Time-stamped values

Up to three timestamped parameters can display on the same screen. The timestamp indicates the time that the displayed parameter was last updated.

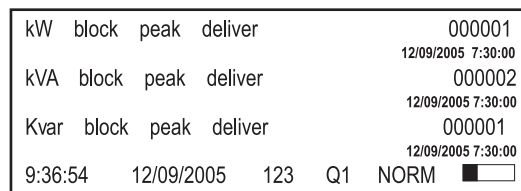

Modes of Operation

The ION 8800 has three modes of operation: NORM, ALT and TEST. Both NORM and ALT are display modes, providing various power system data and meter properties screens. TEST mode is used to perform diagnostics and verify the meter's calibration and function.

NOTE

If your meter has the optional hardware lock, you must open the meter's cover to put it into TEST mode. Refer to "Meter Security Features" on page 48 for more information.

Basic operation (NORM mode)

The ION 8800 meter defaults to NORM mode when powered up, and remains in this mode until you manually switch to ALT or TEST.

NOTE

You can customize NORM mode display screens and alter the front panel's scrolling characteristics by editing the configuration of the meter's Display and Scroll modules – refer to "Display Setup Menu" on page 35 for more details.

If you have a meter *without* the hardware lock, all of the settings available in the panel Setup menu can be changed while the meter is in NORM mode, provided you have the correct password. If you have a hardware-locked meter, only the basic communications parameters in the COM Setup menu can be changed in NORM mode. (You must unlock the meter to change other meter parameters on the hardware-locked meter – refer to "ALT Config Menu" on page 36 for more details.)

ALT mode

ALT mode provides scrolling display screens that show power system data, billing information (including extensive Time of Use data) and meter properties such as Nameplate information.

ALT mode screens are described in "ALT mode default display screens" on page 176.

Switching to ALT mode

Press the **Alt/Enter** button to switch to ALT mode. Press the **Alt/Enter** button again to switch back to NORM mode at any time. If no buttons are pressed, the meter automatically reverts to NORM mode after five minutes. As with any mode, pressing any button temporarily suspends display screen scrolling, allowing you to press the **Up** or **Down** arrow buttons to manually browse the available screens.

TEST Mode

TEST mode is typically used for verifying meter calibration and function. The meter is usually reading data from a test power supply while these functions are performed.

All of the billing quantities that are recorded when the meter is in NORM and ALT mode will stop accumulating when the meter is switched to TEST mode — the data is sent to special TEST mode registers instead. The values accumulated in these test registers are displayed on the front panel (and in ION software).

The regular NORM/ALT mode billing registers are unaffected while the meter is in TEST mode; accumulation of this data continues as soon as you exit TEST mode. All test registers are reset to zero when you exit TEST mode.

For detailed information on TEST mode, see “Switching to TEST Mode” on page 183.

NOTE

The meter will always return to NORM mode when you exit TEST mode, even if you entered TEST mode from ALT mode.

Configuring the Meter with the Front Panel

With the meter's front panel, you can navigate through different menus to perform basic setup on your meter.

Accessing the Setup Menus

To access the Setup menu, press and hold the front panel's **Alt/Enter** button while the meter is displaying power system data. Within the Setup menu is a list of sub-menus that contain the meter's configurable settings. Setup menu items are described in "Front Panel Features" on page 22.

Press the **Up** or **Down** arrow buttons to navigate through the menu. Highlight a menu item and press the **Alt/Enter** button. When you select an item from the Setup menu, you will be presented with another menu of the settings in the meter. You may need to penetrate several layers of menus to access the setting you want to change.

The following diagram shows how the buttons are used to navigate the menus:

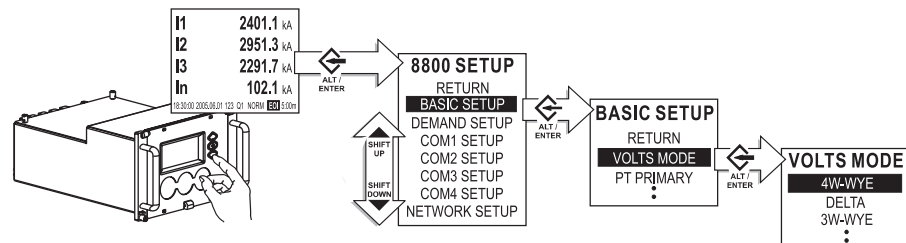

The settings contained in the main Setup menu are:

- Basic Setup:** changes basic settings in the power measurement system configuration.
- Demand Setup:** Rolling Block/Sliding Window Demand settings.
- COM1 Setup:** optical port setup.
- COM2 Setup:** optional RS-485 port setup.
- COM3 Setup:** optional RS-232/RS-485 multiplexed port setup.
- COM4 Setup:** settings for the optional modem.
- Network Setup:** settings for the optional Ethernet port.
- Format Setup:** customizes the style and values appearing on the display screens.
- Display Setup:** customizes display appearance, update time, and demand lockout time.
- Security:** allows you to modify your password, disable the password, disable meter configuration with a web browser, and acknowledge alarms.

Another setup menu, the ALT Config menu, is accessed by pressing a sealed button. See the section "ALT Config Menu" on page 36 for more information.

Returning to Previous Setup Screens

Use the **Up** or **Down** arrow buttons to scroll through the menu items. When the setting you want to change is highlighted, press the **Alt/Enter** button.

To return to a previous screen, highlight the RETURN menu item and then press the **Alt/Enter** button.

Configuring Parameters Using the Navigation Buttons

Use the **Up** or **Down** arrow buttons to change the value (if numeric) or the setting (if enumerated) of the highlighted parameter.

To change the position of the cursor, press and hold the **Up** or **Down** arrow buttons for about one second. The **Up** arrow button moves the cursor one position to the left, and the **Down** arrow button moves the cursor one position to the right. Once you have the value you want, press the **Alt/Enter** button to select it.

NOTE

When setting Ethernet values (IP address, default gateway, etc.), press the Up arrow button to insert additional digit spaces. Press the Down arrow to remove digit spaces (see “Network Setup Menu” on page 33 for more information).

OUT OF RANGE screen

When editing numeric data the numbers below MIN and MAX indicate valid entry bounds. If you enter a value outside valid bounds, you will be presented with an OUT OF RANGE screen. You may then either return to the register you were editing, or choose to exit.



Confirming Configuration Changes

The CONFIRM screen appears whenever you attempt to change the meter's settings through the front panel. This allows you to abort an unwanted configuration change. The front panel also informs you when an entry is out of range. In either case, you must press the **Alt/Enter** button to return to the previous setup screen.

Setup Menus

The following sections describe the various Front Panel setup menus.

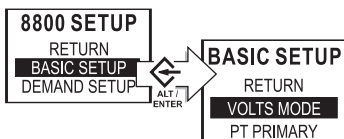

Basic Setup Menu

To view the Basic Setup menu with the meter's front panel, press and hold the **Alt/Enter** button. Press the **Up** or **Down** arrow buttons to highlight Basic Setup, and then press the **Alt/Enter** button..

The Basic Setup menu lets you set volts mode, potential transformer (PT) and current transformer (CT) ratios and various other settings (such as I4 and voltage and current polarities) so that you can ensure that your meter is adequately set for your application.

Many of the settings will be configured when the meter is initially put into service (the device will not operate properly until Volts mode and PT and CT ratios are set), but some settings may need to be changed to refine the device's operation.

See the Basic Setup chapter for more information on the Basic Setup menu.

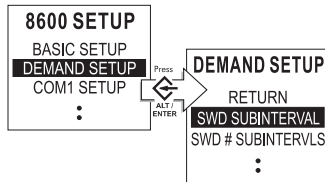

Demand Setup Menu

To view the Demand Setup menu with the meter's front panel, press and hold the **Alt/Enter** button. Press the **Up** or **Down** arrow buttons to highlight Demand Setup, and then press the **Alt/Enter** button.

The Demand Setup menu accesses the global settings for all of the revenue related Rolling Block (Sliding Window) Demand functionality in the ION 8800 meter. The settings provided in the Demand Setup menu control the timing of these demand calculations.

See the Demand chapter for more information on the Demand Setup menu.

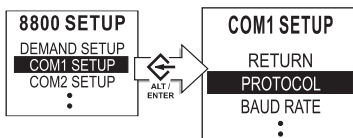

COM Ports Setup Menu

To make changes to communications settings with the meter's front panel, hold down the **Alt/Enter** button for three seconds to enter the Setup menu, then press the **Down** arrow button to select the COM Setup you want. Depending upon the communications options ordered with your meter, the parameter settings available are as follows:

Menu Item	Description
COM1 Setup	Settings for the optical communications port.
COM2 Setup	Settings for the dedicated RS-485 port.
COM3 Setup	Settings for the selectable RS-232 or RS-485 communications port.
COM4 Setup	Settings for the modem.
Network Setup	Settings for the Ethernet communications port.

Serial COM Settings

There are three main parameters that you must set or verify if your meter is connected to a serial network (including modem communications): *Unit ID*, *Baud Rate*, and *Protocol*.

NOTE

Other parameters such as TRANSMIT DELAY, are used in advanced configuration or fine-tuning your system. Settings for the parameters mentioned above are commonly required to get your meter communicating.

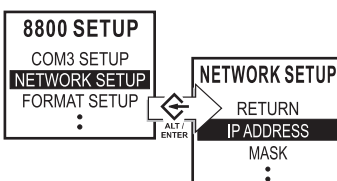

Network Setup Menu

There are two main parameters that you must set or verify if your meter is connected to an Ethernet network: IP address and Subnet mask address.

 **NOTE**

There are other parameters, such as GATEWAY ADDRESS and SMTP ADDRESS, that are used in advanced configuration or in fine tuning your system. The parameters discussed here are the most common parameters required to get your meter communicating.

Configuring Network Settings Through the Front Panel

Typically, your Network Administrator will provide you with the appropriate IP Address for the meter. The Subnet Mask and Gateway settings are only required if you have communications between multiple Ethernet networks and if subnetting is implemented.

 **CAUTION**

Configuring the IP Address, Subnet Mask, and Gateway registers incorrectly can cause network disruptions. See your network administrator for more information.

Use the navigation buttons to edit the values of the network settings so that they match your system addresses. As you configure the network addresses, the front panel automatically discards unnecessary leading zeroes from each three-digit grouping. The hidden leading zeroes appear (and disappear again) as you move the position of cursor across the network address.

89.123.40.056

In the example above, the highlighted zero is discarded as soon as you change the position of the cursor.

For more information, see the Communications chapter.

Format Setup Menu

Format Setup contains the following values that set labeling and formatting preferences.

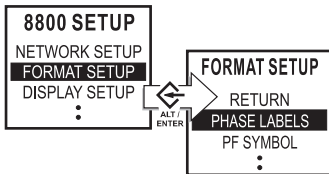

Menu	Setting	Description	Range (Values)	Default
Format	Phase Labels	Specifies how phases are labelled	ABC, RST, XYZ, RYB, 123	123
	PF Symbol	LD (leading)/LG (lagging)	LD/LG, +/-, CAP/IND	LD/LG
	Digit Group	Specifies symbols used to delimit thousands and decimal place holder	1000.0 or 1,000.0 or 1000,0	1000,0
	Date Format	Specifies how dates are displayed	MM/DD/YYYY, DD/MM/YYYY, YYYY/MM/DD	MM/DD/YYYY
	Show DST	Determines if DST is shown or not	Yes or No	Yes
	Volts Decimal	Number of decimal places displayed for voltages	1 to 123 456 789,XXX	1,XX
	Current Decimal	Number of decimal places displayed for currents	1 to 123 456 789,XXX	1,XXX
	Power Decimal	Number of decimal places displayed for power measurements	1 to 123 456 789,XXX	1,XXX

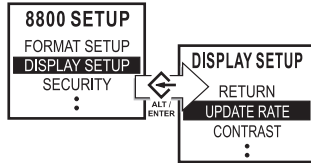

Display Setup Menu

You can configure the following display preferences within Display Setup.

For more information, see the Displays chapter.

Menu	Setting	Description	Range (Values)	Default
Display	Update Rate	Sets when the display updates (in seconds)	1 to 6	1
	Contrast	Higher numbers are sharper	0 to 9	varies
	Backlight TO (Timeout)	Specifies the time it takes the backlight to turn off (zero value causes the display to stay lit indefinitely)	0 to 7 200 seconds (two hours)	300 seconds (five minutes)
	DMD Lock TO	Controls the minimum allowable time between consecutive demand resets (in seconds)	0 (disabled) to 5 184 000 (60 days)	216 000 (25 days)
	TEST Mode TO	Defines how long the meter remains in TEST mode before switching back to NORM mode (in seconds)	60 to 21 600	1800 (30 minutes)
	Display Scale	For display screens that are set to display scaled parameters, this determines the scale applied to displayed parameters	1 to 999 999	1000
	Scaling Mode	Specifies whether parameters are divided or multiplied by the scale before being displayed	Multiply or Divide	Divide

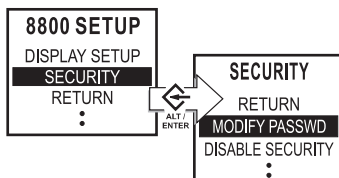

Security Menu

The settings in the front panel Security menu item allow you to:

- ◆ modify the existing meter password or reset it to the factory default
- ◆ disable the password security check
- ◆ enable web browser configuration on the meter
- ◆ acknowledge alarms

You require the valid password to enter the Security Settings menu. The default password is 0 (zero).

For more information, see the Security chapter.

NOTE

The password enables users to change the configuration of the meter. It is recommended that you change your password from the default when you put the meter into service

If you have not yet entered your password, the meter's front panel requires that you enter it before you can view the Security Setup menu. Use the Navigation buttons to enter numerical data. If you enter an incorrect password, the front panel will display an "invalid password" message and you will have to try again.

Modify Password Sub-Menu

Use this sub-menu to change the password, or to reset the password to the factory default (0).

From the meter's front panel select SECURITY, then MODIFY PASSWORD. Two choices appear: MODIFY PASSWORD or FACTORY DEFAULT. Use the Up button to select MODIFY PASSWORD, or the Down button to select FACTORY DEFAULT.

Disable Security Sub-Menu

Use this sub-menu to enable and disable password security on the ION 8800. Disabling the password allows changes to all the meter's settings through the front panel without a security check.

CAUTION

Non-secure access to critical settings in the meter, such as PT and CT ratios, is not advisable. It is highly recommended that any ION 8800 meters in the field have the password security check enabled.

When you re-enable password security, the password is reset to the factory default of 0 (zero). You should re-enter a custom password at this point.

Disabling the Password Security Check is necessary to write to the meter when it is a Modbus Slave device. Refer to "The Meter as Modbus Slave" on page 91 for details about configuring your meter for third-party systems.

Web Config

Use this setting to enable/disable web browser configuration of the meter. See "Enabling and Disabling Web Config Access" on page 52 for more details.

Ack Alarms

Selecting this acknowledges alarms; it is not a configuration setting.

ALT Config Menu

This advanced menu is accessible by pressing the ALT Config button, located under the meter cover.

Setting	Description	Range (Values)	Default
IR Config	Allows meter configuration via the front optical port	Disabled or Enabled	Enabled
Meter Lock ¹	When meter is locked, most meter configuration is prevented, as are meter resets	Locked or Unlocked	Locked ²
Clear Alarms	Sends a pulse to clear alarms when pushed	-	-

¹ After a meter is unlocked, it automatically relocks if you do not perform any configuration for 30 minutes. This function is not available on non-hardware lockable meters.

² Default = 'Locked' on meters ordered with Hardware Lock option.
Default = 'Unlocked' on all other meters (setting is non-functioning).

Chapter
3

Templates and Firmware

Your meter comes installed with a pre-configured default **template**. This template contains various **frameworks** which provide all the power measuring and analyzing functionality of the meter. Templates and frameworks can be used immediately without any user configuration (“right out of the box”). They can also be customized, reconfigured, and pasted from one meter to another.

For more information on templates, frameworks and ION modules, see the *ION Reference*.

Your meter’s operating system is known as **firmware**. When newer firmware is available for your meter, simply upgrade to the latest version for all the added features and functionality.

 **NOTE**

Firmwares and templates for the various meter types (ION 8800A, ION 8800B and ION 8800C) are **not** interchangeable. Make sure when you are upgrading firmware or re-installing templates that you choose the correct files for your meter type.

In This Chapter

◆ Factory Information	38
Factory Module Settings	38
How to TAG Your Meter	38
◆ Restoring the Factory Configuration	39
Using the Front Panel	39
Using ION Setup	39
Using Designer	40
◆ Upgrading Your Meter	41

Factory Information

The Factory module displays firmware version, serial number and other device information in read-only setup registers (read-only registers can be viewed but not changed).

Factory Module Settings

The device information provided is as follows:

Setup Register	Description
Device Type	A device type identifier (e.g. "8800" for the ION 8800)
Compliance	A statement of whether the device is ION compliant or not
Options	Shows model number of meter
Revision	The meter's firmware version
Serial Num	The meter's serial number
ION Version	The ION version supported by the device
Template	The name of the template (framework) installed on the device at the factory
Device Namespace	This configurable string is used as the namespace attribute in the GeneratedBy and Device elements of XML attachments.
Device Name	This configurable string is used as the name attribute in the GeneratedBy and Device elements of XML attachments.
Nom Freq	The expected frequency of the power system being monitored

The Factory module also contains numerous read-only setup registers that hold the calibration constants used at the factory.

How to TAG Your Meter

Three configurable setup registers are provided for you to enter your company name and other text information you want stored in the meter:

Owner - This is a text register for storing user information (e.g. company name); it can be up to 255 characters in length.

Tag 1 - This is a text register for storing user information (e.g. device location); it can be up to 15 characters in length.

Tag 2 - This is a text register for storing user information (e.g. device number or identifier); it can be up to 15 characters in length.

Use ION Setup to configure these registers.

Restoring the Factory Configuration

If you have made changes to the default functionality and want to return to the factory configuration, you can re-initialize the factory configuration in the meter using ION software. The basic setup of the device can be retained, so the meter does not need to be taken out of service for a long period of time.

NOTE

If you restore the factory configuration, all custom features you have created are lost.

Using the Front Panel

You cannot restore the factory configuration from the meter's front panel.

Using ION Setup

1. Download your device's latest template from <http://www.pwr.com/support/downloads/>. Save the .DCF file in the .../ION Setup/TEMPLATE folder for easy access.
2. Connect to your meter in ION Setup, using Basic Mode.
3. Navigate to Setup Assistant > Template.
4. Click the Send to Meter tab and click the Send button.

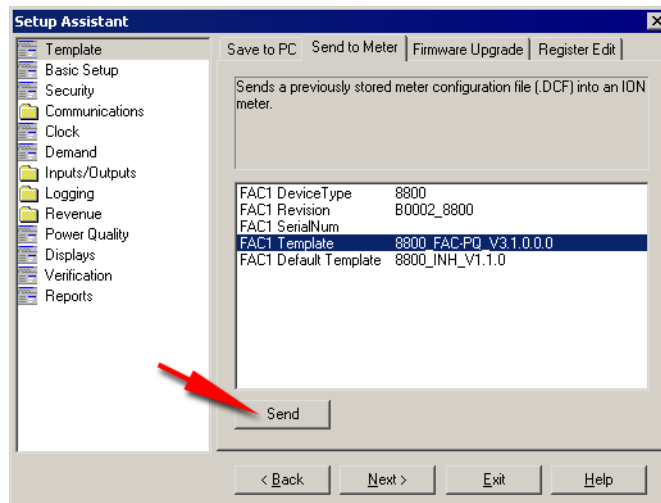

5. Select the .DCF file from the TEMPLATE folder and click OK.

- The Template Paste Options screen appears. Select the check boxes for the settings you wish to retain (not overwrite) and click OK.

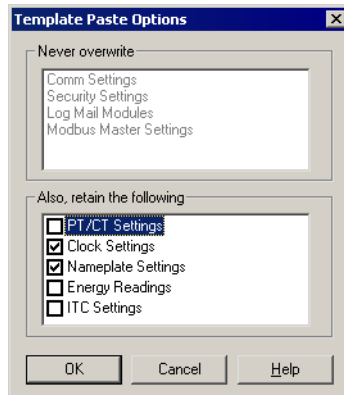

Rapid Meter Programming pastes the template onto your meter. A dialog box confirms the paste was successful.

Using Designer

- Display the meter's main Configuration screen in Designer.
- Choose Select All from the Edit menu, then press Delete.

The confirmation dialog box appears explaining that some modules will not be deleted (core modules cannot be deleted — scroll down in the dialog to see which standard modules will be deleted).

- Click OK on the confirmation dialog box.

After a brief wait the modules are deleted, and the main meter Configuration screen is blank except for the Frameworks folder in the Advanced Setup area. (The Frameworks folder contains the folder of Core modules which cannot be deleted.)

- Choose Select All from the Edit menu to select the Frameworks folder. This selects all subfolders and modules within the folder.
- In the Edit menu, choose Paste from Framework, then select the appropriate.fwn file from the folder \ION Enterprise\config\fmwk\nd\. Click OK.

The Factory module's Default Template register tells you the filename for the default factory framework. (For details about framework files, contact Customer Service or visit the Support area of the Power Measurement web site.)

- Click Open. The Paste Summary window appears.
- Click on the first module, scroll down to the last module, hold the Shift key and click on the last module. This selects all of the modules.
- While holding the Shift key, click on the check box to the left of the module name so you see a lock icon with a green check mark.

 **CAUTION**

Persistent modules can be overwritten in Designer. When pasting a default framework onto a meter, use lock-paste on the Persistent modules, not free-paste. A list of Persistent modules is available from Technical Support.

9. Check “Maintain external inputs” and click OK on the confirmation dialog box.
A message appears indicating that Designer is pasting modules. All modules are selected when the paste is complete. Click anywhere in the background of the node diagram to deselect all of the modules.
10. Click the Power Meter shortcut in the Basic Configuration area to select it. Once selected, click Reset in the Designer toolbar, or select Reset from the Edit menu. This reverts the Power Meter to the settings it had before you deleted any modules (retaining the basic setup you previously had).
11. Choose Send & Save from the File menu. The factory configuration is now restored and any custom functionality you created is removed.

 **NOTE**

The time required to complete steps 3, 5, and 11 may vary depending on your connection and the meter configuration.

See the Designer section in the ION Enterprise online help for more information.

Upgrading Your Meter

See the *Upgrading ION Device Firmware* technical note for details.

Chapter
4

Basic Setup

This chapter explains how to perform basic meter setup using the front panel or ION software.

In This Chapter

- ◆ **Introduction** **44**
- Configuring Basic Setup 44
- Using the Front Panel 44
- Using ION Setup 45
- Using Designer 45
- Power Meter Module Settings 46

Introduction

Basic configuration of the meter is provided by the Power Meter module. The Power Meter module is the main connection between the power system measurements and all other ION modules in the device. This module reports the values for all voltage, current and power measurements. The Power Meter module's setup registers describe details of the power system being monitored. Many of the Power Meter module's setup registers are configured when the meter is initially put into service, although the device cannot operate properly until the Volts Mode and PT and CT ratios are set. Some registers may need to be changed to refine the device's operation.

See the *ION Reference* for more details on the Power Meter module.

Configuring Basic Setup

Use the front panel or ION software to perform basic meter setup.

Using the Front Panel

The Basic Setup menu item provides access to the following power system settings.

Menu	Setting	Description	Range (Values)	Default
Basic Setup	Volts Mode	The power system's configuration – WYE, DELTA, etc.	4W-WYE DELTA 3W-WYE SINGLE DEMO	4W-WYE
	PT Primary	The Potential Transformer's primary winding voltage rating	1 to 999 999 999	120,00
	PT Secondary	The Potential Transformer's secondary winding voltage rating	1 to 999 999 999	120,00
	CT Primary	The Current Transformer's primary winding current rating	1 to 999 999 999	5
	CT Secondary	The Current Transformer's secondary winding current rating	1 to 999 999 999	5
	I4 Primary	Primary rating for the I4 current transformer	1,0 - 999 999,00	5
	I4 Secondary	Secondary rating for the I4 current transformer	1,0 - 999 999,00	5
	U1 Polarity	The polarity of the Potential Transformer on U1	Normal or Inverted	Normal
	U2 Polarity	The polarity of the Potential Transformer on U2	Normal or Inverted	Normal
	U3 Polarity	The polarity of the Potential Transformer on U3	Normal or Inverted	Normal
	I1 Polarity	The polarity of the Current Transformer on I1	Normal or Inverted	Normal
	I2 Polarity	The polarity of the Current Transformer on I2	Normal or Inverted	Normal
	I3 Polarity	The polarity of the Current Transformer on I3	Normal or Inverted	Normal
	I4 Polarity	The polarity of the Current Transformer on I4	Normal or Inverted	Normal
Phase Rotation	Power system's phase rotation	+23, +32	+23	

Using ION Setup

The Basic Setup Assistant helps you configure the Power Meter module:

1. Open ION Setup and connect to your meter, using Basic Mode.
2. In the Setup Assistant, navigate to Basic Setup and click on the PT/CT Ratios tab.

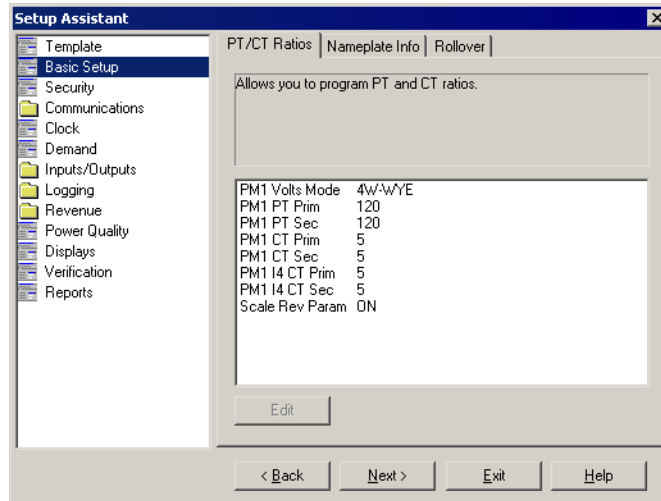

3. Configure each register as required by selecting the parameter and clicking Edit.

Using Designer

Open your meter in Designer and navigate to the Basic Configuration Framework. Right-click on the Power Meter module to edit.

Power Meter Module Settings

The Power Meter module contains the following setup registers:

Setup Register	Function	Default
Volts Mode ¹	The power system's configuration – WYE, DELTA, Single, etc	4W-WYE
PT Prim ¹	The Potential Transformer's primary winding rating for U1, U2, U3, and U4	120
PT Sec ¹	The Potential Transformer's secondary winding rating for U1, U2, U3, and U4	120
CT Prim ¹	The Current Transformer's primary winding rating for I1, I2 and I3	5
CT Sec ¹	The Current Transformer's secondary winding rating for I1, I2 and I3	5
I4 CT Prim ¹	The Current Transformer's primary winding rating for I4	5
I4 CT Sec ¹	The Current Transformer's secondary winding rating for I4	5
U1 Polarity	The polarity of the Potential Transformer on U1	Normal
U2 Polarity	The polarity of the Potential Transformer on U2	Normal
U3 Polarity	The polarity of the Potential Transformer on U3	Normal
I1 Polarity	The polarity of the Current Transformer on I1	Normal
I2 Polarity	The polarity of the Current Transformer on I2	Normal
I3 Polarity	The polarity of the Current Transformer on I3	Normal
I4 Polarity	The polarity of the Current Transformer on I4	Normal
Phase Order	The expected rotation of the voltage phases (ABC or ACB)	ABC
Phase Lbls	The phase label format assigned to the outputs (ABC, RST, XYZ, RYB, RWB or 123)	123

¹ The registers are typically set when the device is commissioned. Changing the values of these registers while the device is in service is not recommended.

Once basic setup is performed (i.e. the PT/CT and Volts mode settings), typically there is no need to make further changes to the Power Meter module's setup registers.

Chapter
5

Security

All ION 8800 meters offer Standard and Advanced meter security. Standard security is enabled by default from the factory; procedures for changing these security settings using the front panel and ION software are detailed in this chapter. Advanced security, which allows up to 16 users, each with unique access privileges, is discussed as well. This chapter also details some security features available for revenue meters.

In This Chapter

◆ Meter Security Features	48
◆ Standard Meter Security	49
Configuring Standard Security using the Front Panel	49
Time Synchronization Security Considerations	52
Configuring Standard Security using ION Setup	53
Configuring Standard Security in Designer	55
Scenarios for Standard Security - Front Panel Security Enabled	56
◆ Configuring Advanced Meter Security	59
Configuring Advanced Security using ION Setup	60
Configuring Advanced Security using ION Enterprise	61
Device Security Access for ION Services	62
Scenarios for Advanced Security - Standard Security Enabled	64
◆ Additional Revenue Metering Security	67
Hardware Lock Security Option	67
Meter Seals	67

Meter Security Features

Your meter includes the following security features:

Standard meter security

Anytime you make configuration changes to your meter you must enter a password. See “Standard Meter Security” on page 49.

Advanced meter security

This level of security allows configuration of up to 16 users, each with unique access rights to the meter. See the topic “Configuring Advanced Meter Security” on page 59.

Revenue meter security

Your revenue meter can be protected by hardware locking and anti-tamper sealing. See “Additional Revenue Metering Security” on page 67.

Software security

ION software security brings access-level security to the meter. With ION software, you can configure multiple users with different passwords and specify access rights. ION software security only applies to users who are accessing the meter via ION software.

For more information on ION software security, refer to the *ION System Security* technical note.

Standard Meter Security

Standard meter security is enabled by default on all ION 8800 meters; all configuration functions in the front panel are password-protected. The password is factory-set to 0 (zero).

If you make configuration changes to the meter via the front panel, the meter prompts you for its password before accepting any configuration changes. Similarly, if you make any configuration changes via ION software you are prompted by the meter for its password (in addition to the password used to access ION software). Once you enter the correct meter password and confirm the new configuration, the change is set on the meter.

Configuring Standard Security using the Front Panel

Navigate to the Security Setup menu. The following settings are available:

Menu	Setting	Description	Range (Values)	Default
Security	Modify Passwd	Modifies standard password	0 to 999 999 999	0
	Disable Security	Disables meter security	Disabled or Enabled	Enabled
	Web Config	Allow configuration through web server interface	Disabled or Enabled	Enabled
	Ack Alarms	Sends a pulse to acknowledge alarms when pushed	-	-

Note that the front panel will prompt you for the meter password before you make your first configuration change. You will not need to re-enter the password for each subsequent change. However, if you perform no additional configuration changes for five minutes, you will need to re-enter the Setup menu and provide the valid meter password to resume making changes. This is because the meter returns from setup mode to data display mode after five minutes of inactivity.

The meter password allows access to the meter's configuration through ION software and the front panel. The default password is 0 (zero).

Entering the Password

The first time you try to make a change to any setting, you will be presented with the password screen (shown below). After you have entered the correct password, you will not have to re-enter it for other any other changes unless you exit the configuration session.

ENTER PASSWD

00000000

MIN: 00000000 MAX: 99999999

HOLD ARROW KEY TO ADVANCE CURSOR

To enter the password:

1. To change the value of the highlighted digit, use the arrow buttons. The Up arrow increments the number and the Down arrow decrements it.
2. To change the position of the cursor, hold down an arrow button for about one second. The Up arrow moves the cursor left one position, and the Down arrow moves the cursor right one position.
3. Once you have the value you want, press the **Alt/Enter** button.

Changing the Password

By default, the password is set to 0 (zero) in the factory. The password may be changed to any eight-digit number. It is highly recommended that you change the password from the default value. To change the password:

1. Hold down the **Alt/Enter** button to access the Setup menu.
2. Scroll through the menu items using the arrow buttons, highlight SECURITY.
3. Press the **Alt/Enter** button to select SECURITY.

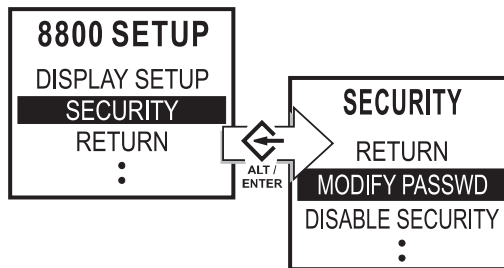

4. You will be prompted to enter the current meter password (see “Entering the Password”, above). Once you enter the password, you are presented with the “MODIFY PASSWD” screen, as seen below:

MODIFY PASSWD

00000000

MIN: 00000000 MAX: 99999999

HOLD ARROW KEY TO ADVANCE CURSOR

5. To change the value of the highlighted digit, use the arrow buttons. The Up arrow increments the number and the Down arrow decrements it.
6. To change the position of the cursor, hold down an arrow button for about one second. The Up arrow moves the cursor left one position, and the Down arrow moves the cursor right one position.
7. Once you have the value you want, press the **Alt/Enter** button. You will be prompted for your current password before the new password is saved.

Enabling & Disabling the Password Security Check

Disabling the password allows changes to all the meter's settings through the front panel without a security check. This procedure may only be necessary if the communications interface you are using does not support the meter's security protocols.

CAUTION

Non-secure access to critical settings in the meter, such as PT and CT ratios, is not advisable. It is highly recommended that any ION 8800 devices in the field have the password security check enabled.

Disabling the Password Security Check

Follow these steps to disable the password security check:

1. Press the **Alt/Enter** button to enter the Setup menu. Scroll down the menu with the arrow button. Press **Alt/Enter** again when SECURITY is highlighted.
2. Enter the valid meter password at the password prompt. You are then presented with the Security menu.
3. Scroll down and highlight the DISABLE SECURITY menu item and press the **Alt/Enter** button.

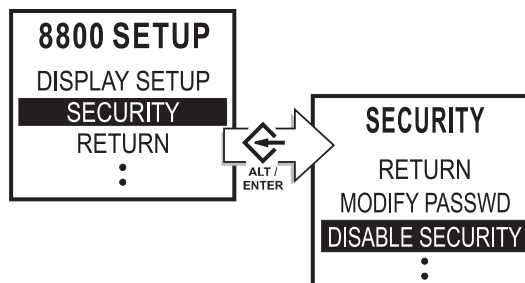

4. Select PROCEED, then select YES at the following prompt.

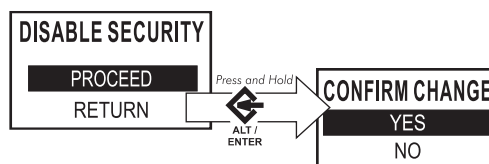

A message appears on screen notifying you of how to re-enable password security (refer to “Enabling the Password Security Check”, below). Your meter's password is now disabled; changes to settings in the meter do not require a valid password.

5. Press the **Alt/Enter** button to return to the Setup menu.

Enabling the Password Security Check

When you re-enable the password security, you are required to enter a new password. To re-enable password security:

1. Press and hold down the **Alt/Enter** button to enter the Setup menu. Scroll down the menu and select SECURITY.
2. From the Security menu, select MODIFY PASSWD, and press the **Alt/Enter** button. The Modify Password Screen appears.
3. The message FAC DEFAULT appears in the middle of the Modify Password screen. If you want to use the factory default password, press the **Alt/Enter** button. If you want to set the password to a different eight-digit number, use the instructions in "Changing the Password" on page 50.
4. Once you have entered your new password, press the **Alt/Enter** button.
5. Select YES to confirm the change and return to the Setup menu.

The password security check is re-enabled, and all changes to the device's configuration require the new meter password.

Enabling and Disabling Web Config Access

By default, remote configuration of the device via web browser is enabled. Follow these steps to enable or disable your meter's web configuration access.

1. Press the **Alt/Enter** button to enter the Setup menu. Scroll down the menu with the arrow button. Press **Alt/Enter** again when SECURITY is highlighted.
2. Enter the valid meter password at the password prompt. You are then presented with the Security menu.
3. Scroll down and highlight the WEB CONFIG menu item and press the **Alt/Enter** button.
4. Select "Enabled" or "Disabled" as required.
5. Confirm the change and select RETURN to go back to the Setup Menu.

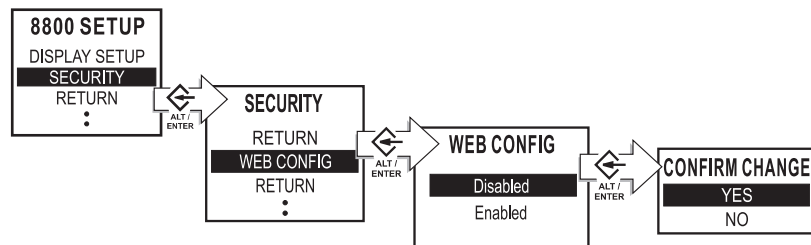

Time Synchronization Security Considerations

Depending on ION software settings, a workstation that connects to an ION 8800 device may send a time synchronization signal and synchronize the meter's internal clock with the workstation's clock. This could cause overlaps in the Demand intervals, and timestamps in the data logs may not be accurate.

Ensure that the *TimeSynch Source* setup register in the Clock module is set to a secure communications port. By default, the *Time Synch Source* setup register in the Clock module is set to COM1 - the optical port. Time synchronization broadcasts will only be accepted through the optical port in this configuration. Use the Clock Setup Assistant in ION Setup to change this setting. See below.

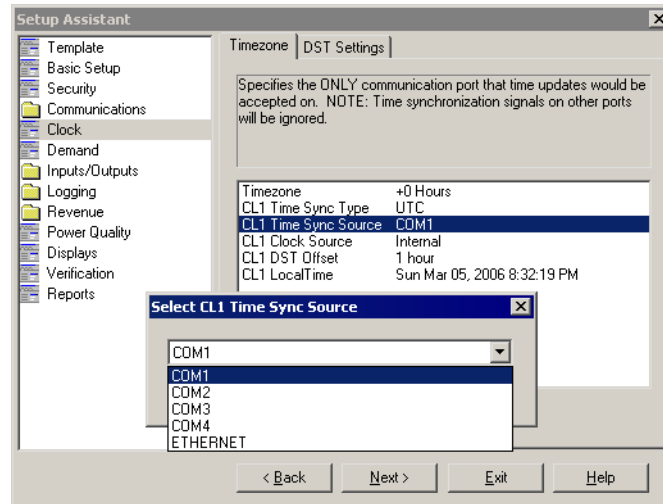

Ensure that time synchronization is disabled on all other ports.

Configuring Standard Security using ION Setup

1. Launch ION Setup with Supervisor authority.
2. Connect to your meter, using Basic Mode.
3. In the Setup Assistant, navigate to Security.
4. Select Security Mode and click **Edit**.

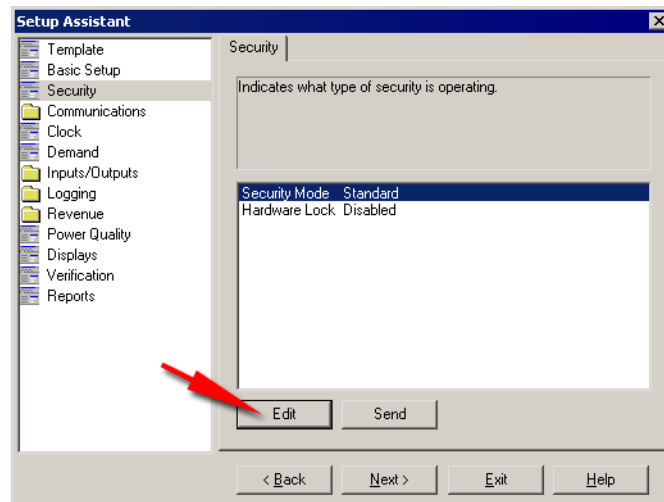

5. In the Open File dialog, select the Standard.scf file and click **Open** to edit.

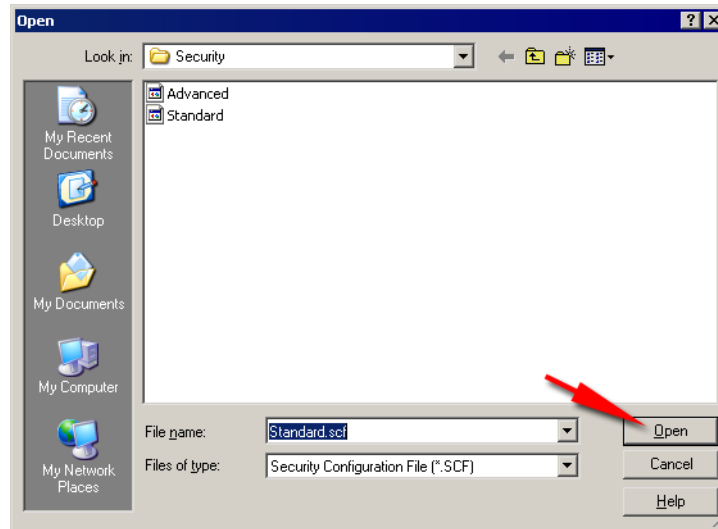

6. On the configuration screen, select the check boxes of the security options you want enabled. Some options may be greyed out (not changeable) due to existing security settings.

To change the password, enter a new meter password and then confirm by entering it again.

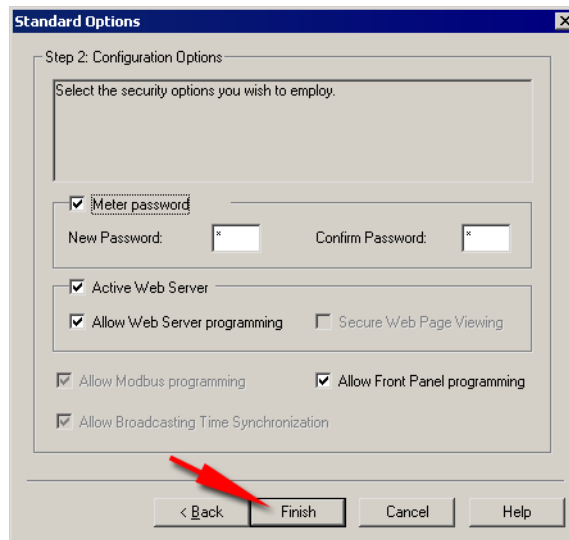

7. Click **Finish** when you are done.
8. When prompted, you can choose to save your security settings in a file.

Click **Yes**, enter a new name for your security file and click **Save**. If you want to overwrite your default standard security file, select Standard.scf and click **Save**.

Click **No** if you do not want to save the changes.

Configuring Standard Security in Designer

1. Launch Designer software with Supervisor access.
2. Select Options > Show Toolbox if the toolbox is not displayed.
3. From the Options menu, select Change Standard Meter Security...

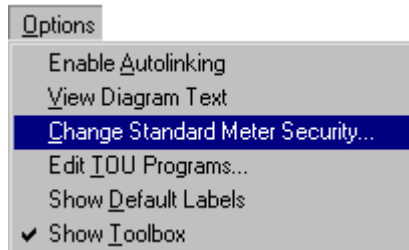

4. Enter the meter password when prompted. You must enter the existing meter password before you can change security settings (the default is zero).

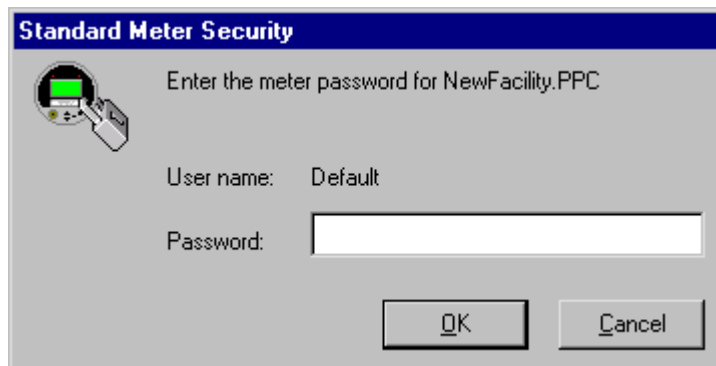

5. Type a new numeric password and confirm by re-typing the password in the fields (see image below). If you are sure you want to disable Standard security, click the Disable Standard Meter Security check box.

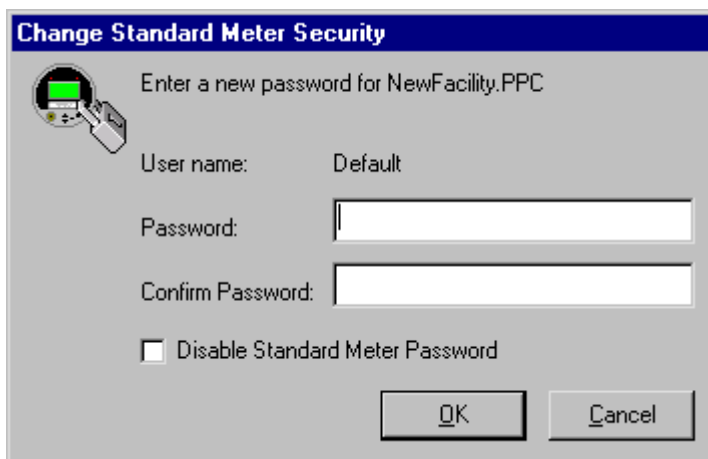

⚠ CAUTION

Do not disable security unless it is absolutely necessary. Disabling Standard security leaves your meter configuration open to tampering (intentional or unintentional) through communications and the front panel.

Scenarios for Standard Security - Front Panel Security Enabled

1. Access through the front panel display

With the Standard Security enabled and Front Panel Programming set to “Allowed”, you can read metering data from the display. To configure meter parameters, you must enter the numeric password.

If Standard Security is disabled and Front Panel Programming is set to “Allowed”, you can read metering data from the display and configure or make changes without entering in a password.

If Front Panel Programming is set to “Disallowed”, you can read metering data from the display, but you cannot access any of the configuration screens from the front panel display.

2. Access through software talking ION protocol with ION Setup and/or ION Enterprise on ANY comm port (serial, modem, optical and Ethernet)

If you are communicating through ION protocol (and have Standard Security enabled) with the appropriate software access, you can read and configure meter parameters. When you attempt to write or configure any parameter, you must enter in the numeric password.

3. Access through Modbus on ANY comm port (serial, modem, optical and Ethernet)

On ION meters, Modbus implementation consists of two parts:

- i. Modbus Data
 - ◆ Includes the Modbus Slave ION modules.
 - ◆ These modules are configurable as to what data is available and where in the range of Modbus registers this data is placed.
- ii. Modbus Setup
 - ◆ Also referred to as the Modbus Map (see *Common Modbus Registers* document).
 - ◆ Uses fixed functionality and register mapping.

4. Accessing the Modbus data section with Standard Security

When accessing the Modbus Data section with Standard Security enabled, you:

- ◆ Can read from the data section at all times.
- ◆ Can write to the data section if the Modbus Slave Module is set to “Unsigned 16Bit Input Mode”, and the Standard Security is disabled or the password is set to zero.
- ◆ Cannot write to the data section if the Standard Security is enabled and the password is set to a non-zero value.

5. Accessing the Modbus setup section with Standard Security

When accessing the Modbus Setup Section with Standard Security enabled, you:

- ◆ Can read from the setup section at all times.
- ◆ Can write to the setup section if the Standard Security is disabled or the password is set to zero.
- ◆ Cannot write to the setup section if the Standard Security is enabled and set to a non-zero value.

Time syncs are considered to be a Modbus Setup parameter and follow the same rules above for writing a time sync to the meter. Also, the ION Clock Module must have its *Time Sync Source* setup register set to the appropriate communication port.

The Modbus Slave module and the Clock module setup registers are only accessible via ION protocol. Their settings are therefore protected by the security settings on the ION device.

6. Access through DNP 3.0 on ANY serial, modem or optical communication port

If you are communicating through DNP 3.0 protocol over any serial, modem or optical port (and Standard Security is enabled), you can read data from the default DNP 3.0 Map without having to enter the numeric password.

If the DNP 3.0 Map is changed to expose control and setup parameters, then you could write to the custom DNP 3.0 Map. The DNP 3.0 Map can only be changed by using ION Setup or ION Enterprise and then the customer must know the numeric password. Time syncs can be sent to the meter in this mode.

7. Access through a standard browser on an Ethernet port via HTTP protocol

If the Standard Security is enabled and Webserver Configuration Access is enabled then you will be prompted for the password by your web browser before being allowed to make any configuration changes to the meter. If the Standard Security is not enabled, then you will be able to make configuration changes without having to supply the password.

If Webserver Configuration Access is disabled, you can only read data. The default Webserver pages contain real-time data only.

8. Access through FACTORY protocol on a Telnet connection via Ethernet or HyperTerminal on a serial, modem, or optical port

If the Standard Security is enabled, you must enter the numeric password to log into the Factory protocol. If Standard Security is disabled, logging in via Factory protocol does not require a password.

Once logged in, you can change the following:

1. IP Address
2. Subnet Mask
3. Gateway
4. Reset Battery Counters
5. Enable/Disable Standard Security

If you wish to change additional configuration settings beyond the above list, contact Technical Support.

Configuring Advanced Meter Security

Advanced meter security is available on ION 8800 meters. This level of security allows configuration of up to 16 users, each with unique access rights to the meter. Access rights consist of the following levels:

- ◆ **Read:** view any parameter except the security configuration.
- ◆ **Peak Demand Reset:** perform a reset of peak demand values (for example, sliding window demand for kW, kvar, kVA etc.).
- ◆ **Timesync:** set the time on the meter.
- ◆ **Full Meter Configuration:** configure any programmable register on the meter except for registers related to the security setup, registers that result in a demand reset, or actions that place the meter in TEST mode.
- ◆ **TEST Mode:** put the meter into TEST mode.
- ◆ **Advanced Security Configuration:** configure Advanced security for the meter; full meter configuration must also be set to YES.

When configuring users, in most cases you must set Read access to YES. However, you can set up a user without read access; for example, you may want to create a user who can only timesync the meter. In some cases (such as Advanced security configuration access) you must set multiple access options to YES. When you are configuring Advanced security, the software rejects unacceptable or unsafe user configurations.



NOTE

Use only ION Enterprise or ION Setup v1.1 (or later) to configure Advanced security. You cannot configure Advanced Security using the Front Panel.

Entering an advanced security user name and password

When you attempt to view data or make a change to a meter that has advanced security enabled, you are prompted for a user name and password.

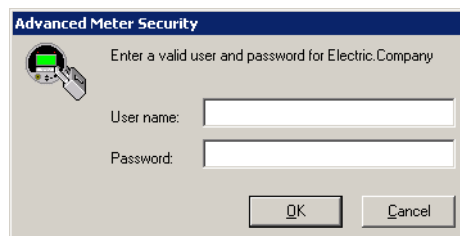

1. Enter the valid Advanced security user name.



NOTE

User names are fixed as USER1 through to USER16.

2. Enter the appropriate password and click OK.

Configuring Advanced Security using ION Setup

See the *ION Setup User Guide* for more details.

1. Launch ION Setup with Supervisor access.
2. Connect to the meter you want to configure with Advanced security.
3. Once connected, double-click the Setup Assistant and select the Security heading.
4. Select Security Mode and click **Edit**.
5. In the Open File dialog, select the Advanced.scf file and click **Open**.

The Advanced Security wizard leads you through the configuration procedure.

6. On the first configuration screen, select the check boxes of the security options you want enabled. Some options may be greyed out (not changeable) due to existing security settings. Click **Next**.

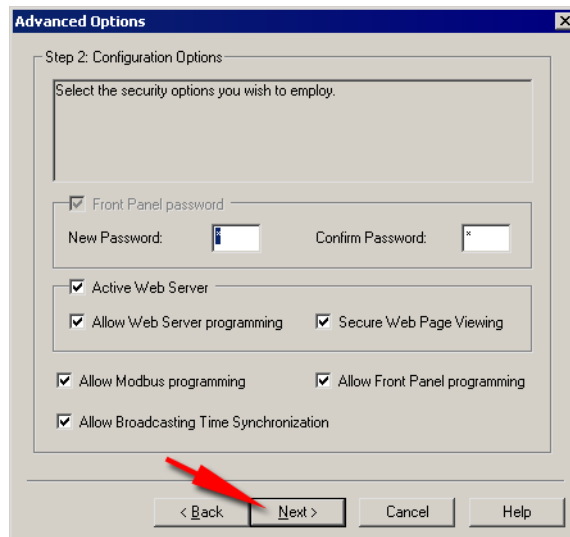

7. On the second configuration screen, select the check boxes of the users you want to configure (1 through 16). Click **Password** to set a password for each user. Click **OK** then click **Finish**.

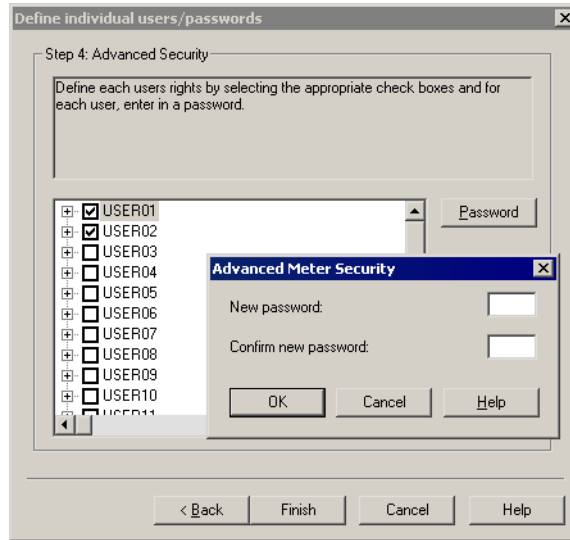

8. When prompted, you can choose to save your security settings in a file.
Click **Yes**, enter a new name for your security file and click **Save**. If you want to overwrite your default advanced security file, select `Advanced.scf` and click **Save**.
9. Click **No** if you do not want to save the changes.

Configuring Advanced Security using ION Enterprise

If you are using Designer software follow the instructions below.

1. Launch Designer software with Supervisor access. From the File menu choose Open... and select the meter you want to configure with Advanced security.
2. If the toolbox is not displayed, choose Options from the main menu and select Show Toolbox.
3. If you do not want to allow front panel programming using the Standard security meter password then double-click on the Display Options module and change the Front Panel Programming register to disallow.

NOTE

If you allow front panel programming when you set up Advanced security, the meter password (used in Standard security) is still active through the front panel. You may need to allow front panel programming if someone installs the meter in the field and needs to make setup modifications. Once the meter is installed, you can disallow front panel programming so that Advanced security user names and passwords must be used to view or change meter information.

4. Double-click on the Meter Security Setup folder.
For each user you want to configure, drag out a Security User module from the Toolbox, and modify the appropriate access level setup registers.
5. Click the Change Password button at the bottom left of the module setup screen to configure a password. The default password is zero (0).

Click OK when you have configured the users.

6. Right-click on the Security Options module.
7. Double-click on any setup register and use the drop-down menu to change the register setting or label.

You must set the *Enable Advanced Security* register to Enabled. Refer to the Security Options module description in the *ION Reference* for more details.

8. From the File menu choose Send & Save. Advanced security is now enabled on the meter.

Device Security Access for ION Services

Many ION Services need constant access to your network's ION devices. These services include the ION Log Server, the Virtual processor and Site Server that perform the following type of functions:

Service	Function
ION Log Server	Reads the ION meter Data Recorder or waveform modules and can automatically rearm recorders that are configured as Stop-When-Full
Virtual Processor	Can be configured to read from a meter or perform control action using Distributed Control.
Site Server	Broadcasts time signals to the meter.

When Advanced meter security is enabled, these services may not have sufficient access rights to perform their operations. You must specify a user with sufficient access rights for these services.

NOTE

You may want to configure a separate user for accessing services. If you observe trouble with ION software accessing the meter, it is likely that these services either do not have access rights or the original user name and password have changed.

Allowing ION Services access to advanced security enabled meters (ION Enterprise)

1. Launch the Management Console and click Devices on the Management Console's System Setup Pane.
2. Highlight the ION device (or select multiple devices) with Advanced security enabled, right-click and select Security... The following window displays.



3. Select the user name you want from the drop down menu. Once you select a user the Change Password button is active. Click the check box if you want to allow this user to send time synchronization signals to the meter. Click OK.
4. Enter the valid password, re-type the password to confirm and click OK.

Allowing ION Services access to Standard security enabled meters (ION Enterprise)

1. Launch the Management Console and click Devices on the Management Console's System Setup Pane.
2. Highlight the ION device (or select multiple devices) with Standard security enabled, right-click and select Security....
3. Select Standard Security from the drop down menu. Click the check box if you want to allow this user to send time synchronization signals to the meter. Click OK.
4. Enter the valid meter password for Standard Security, re-type the password to confirm, and click OK.

Allowing ION Services access to advanced security enabled meters (ION Setup)

1. Launch ION Setup with Supervisor access.
2. Connect to the meter you want to configure with Advanced security.
3. Once connected, double-click the Setup Assistant and select the Security heading.
4. Select Security Mode and click **Edit**.
5. In the Open File dialog, select the Advanced.scf file and click **Open**. Click **Next**.
6. Select the user name you want from the available list.

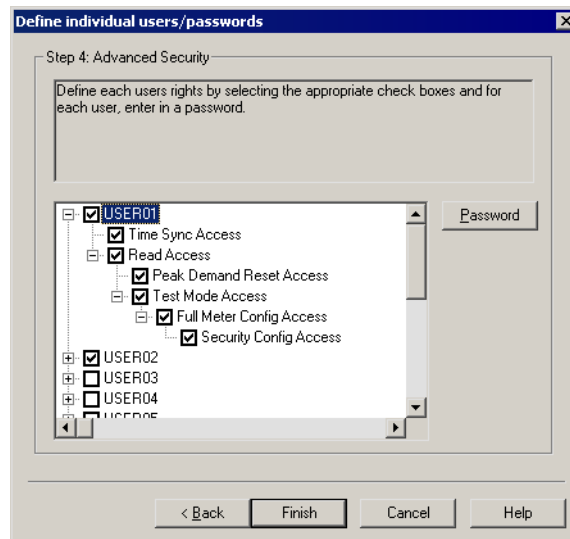

7. Select the check boxes of the services you want to allow this user to access. Click **Finish**.

Scenarios for Advanced Security - Standard Security Enabled

1. Access through the front panel display

With both Advanced Security and Standard Security enabled, you can read the metering data on the display. To configure/write to the meter, enter the numeric password. Advanced Security does not add additional security when accessing the meter through the front panel.

2. Access through software talking ION protocol with ION Setup and/or ION Enterprise on ANY comm port (serial, modem, optical and Ethernet)

With Advanced Security enabled and communicating through ION protocol on any communication port, you must enter a username and password in order to read or configure/write the meter. Advanced Security blocks access to the device if you do not know the correct username and password. If you know the username and password, and the username is assigned the proper access, then you can read and configure/write (depending on the assigned user-access rights) data within the meter.

3. Access Through Modbus on ANY comm port (serial, modem, optical and Ethernet)

On ION meters, Modbus implementation consists of two parts:

- i. Modbus Data
 - ◆ Includes the Modbus Slave ION modules.
 - ◆ These modules are configurable as to what data is available and where in the range of Modbus registers this data is placed.
- ii. Modbus Setup
 - ◆ Also referred to as the Modbus Map (see *Common Modbus Registers* document).
 - ◆ Uses fixed functionality and register mapping.

From an Advanced Security point of view, the Modbus Data and Setup sections operate somewhat differently.

When accessing the Modbus Data Section with Advanced Security Enabled, you:

- ◆ Can still read from the data section at all times.
- ◆ Can write to the data section if the Modbus Slave Module is set to “Unsigned 16Bit Input Mode”, and the “Modbus Map Access” is set to “Yes”.
- ◆ Cannot write to the data section if “Modbus Map Access” is set to “No”.

When accessing the Modbus Setup Section with Advanced Security Enabled, you:

- ◆ Can read from and write to the data section if “Modbus Map Access” is set to “Yes”.

- ◆ Cannot read from or write to the data section if “Modbus Map Access” is set to “No”.

You can write a time sync only if “Modbus Map Access” and “Allow Broadcast Time syncs” are both set to “Yes”, and the ION Clock Module’s “Time Sync Source” setup register is set to the appropriate communication port.

Since the Modbus Map Access, the Modbus Slave module, and the Clock module setup registers are only accessible via ION protocol, their settings are protected by the security settings on the ION device.

4. Access through DNP 3.0 on ANY serial, modem or optical port

With Advanced Security enabled and communicating through DNP 3.0 protocol over any serial, modem or optical port, you can read from the default DNP 3.0 Map. If the DNP 3.0 Map is changed to expose control and setup parameters, then you can write to the custom DNP 3.0 Map. Any changes to the DNP 3.0 Map or the Security Options Module can only be changed by using ION Setup or ION Enterprise and the customer must know the proper Advanced Security username and password. Time syncs can be sent to the meter in this mode without having to enter in a username and password.

5. Access through a standard browser on an Ethernet port via http protocol

If Advanced Security is enabled and the Web Access Read Security setup register in the Security Options Module is set to YES, you must enter in the proper Advanced Security username and password before gaining read access to the device through a standard browser. If you have the proper username and password, the next level of security is the Webserver Configuration Access setting. If the Webserver Configuration Access disabled, you can only read metering data.

If the Web Access Read Security setup register is set to NO, then you will be able to read web pages on the device without having to provide an Advanced Security username and password. However, if you attempt to make configuration changes, you will be prompted for the Advanced Security username and password.

6. Access Through FACTORY protocol on a Telnet connection via Ethernet or HyperTerminal on a serial, modem, or optical port

Advanced Security does not affect the Factory protocol. Therefore, if Standard Security is enabled, you will have to enter the password to log into the Factory protocol. If the Standard Security is disabled you can log into the Factory protocol without supplying a password.

Once logged in, you can change the following:

1. IP Address
2. Subnet Mask

3. Gateway
4. Reset Battery Counters
5. Enable/Disable Standard Security

If you wish to change additional configuration settings beyond the items listed above, contact Technical Support.

Additional Revenue Metering Security

Security features depend on the meter ordering options. See below.

All ION 8800 meters

Standard security includes traditional anti-tamper mechanical sealing points on the meter case and cover.

ION 8800 meters with Revenue Security Option

Standard security plus a hardware-locked security system that prevents modification of revenue quantities after the meter is sealed.

Hardware Lock Security Option

To make configuration changes to billing parameters on a hardware-locked meter, you must first unlock the meter. The Meter Lock setting is located in the ALT Config menu, which is reached by pressing the ALT Config button under the anti-tamper sealed cover. This button cannot be activated remotely with a Hardware Lock meter.

Typical values that are protected include:

- ◆ kWh, kvarh, kVAh delivered, received, del-rec, del+rec.
- ◆ kW, kvar, kVA Sliding Window demand min and max values.
- ◆ Digital Outputs controlling the energy pulsing applications.
- ◆ All Power system settings, including PT and CT ratios.

For a complete list of locked values specific to your meter and its firmware, contact Technical Support.

Meter Seals

Rear of Meter

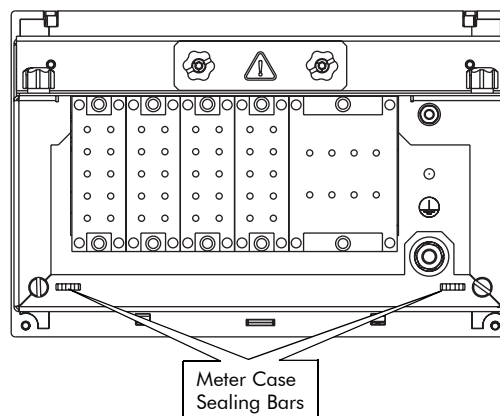

Front of Meter

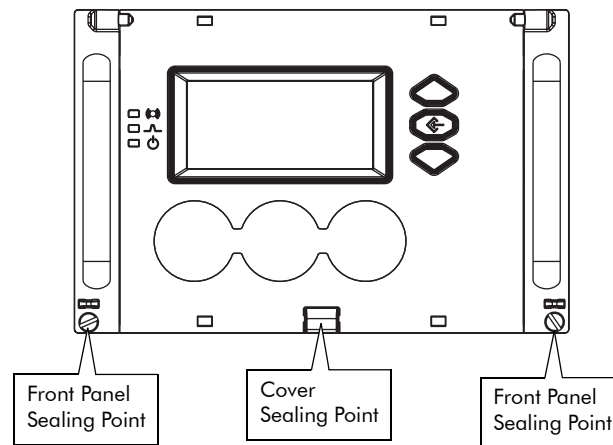

The meter incorporates sealing bars and chassis screws with through-holes, through which traditional lead/wire seals can be inserted. When utilized, these lead/wire seals effectively prevent unauthorized personnel from gaining access to meter internals or to buttons under the cover.

These seals are installed as follows:

1. Insert the sealing wire through **both** the screw hole and sealing bar.

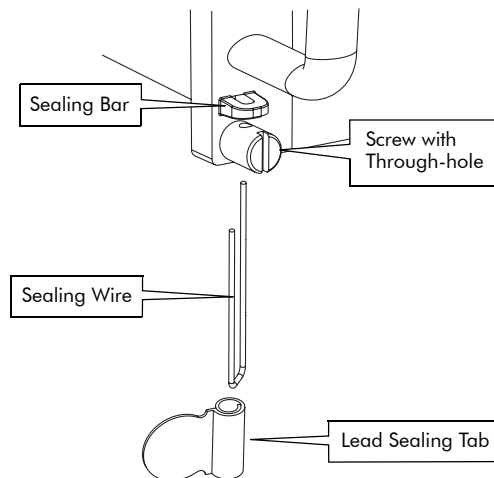

2. Twist the wire and crimp the lead-sealing tab on to the wire.

Chapter
6

Communications

This chapter includes general instructions for connecting and configuring all the communication ports on your meter.

For specific meter installation steps and specifications, consult your Installation Guide.

In This Chapter

◆ Communications Overview	70
◆ Communications Connections	71
Optical Port Connections (COM1)	72
RS-485 Connections (COM2 and COM3)	72
RS-232 Connections (COM3)	74
Ethernet Connections	75
Internal Modem Connections (COM 4)	76
◆ Configuring Meter Communications	77
Serial Communications Setup	78
Ethernet Communications Setup	80
Modem Communications Setup	83
◆ Internet Connectivity	85
WebMeter Feature	85
MeterM@il Feature	85
WebReach	86
Telnet and HyperTerminal	86
◆ Communications LEDs	87

Communications Overview

The following illustration shows all the possible communications connections to the meter.

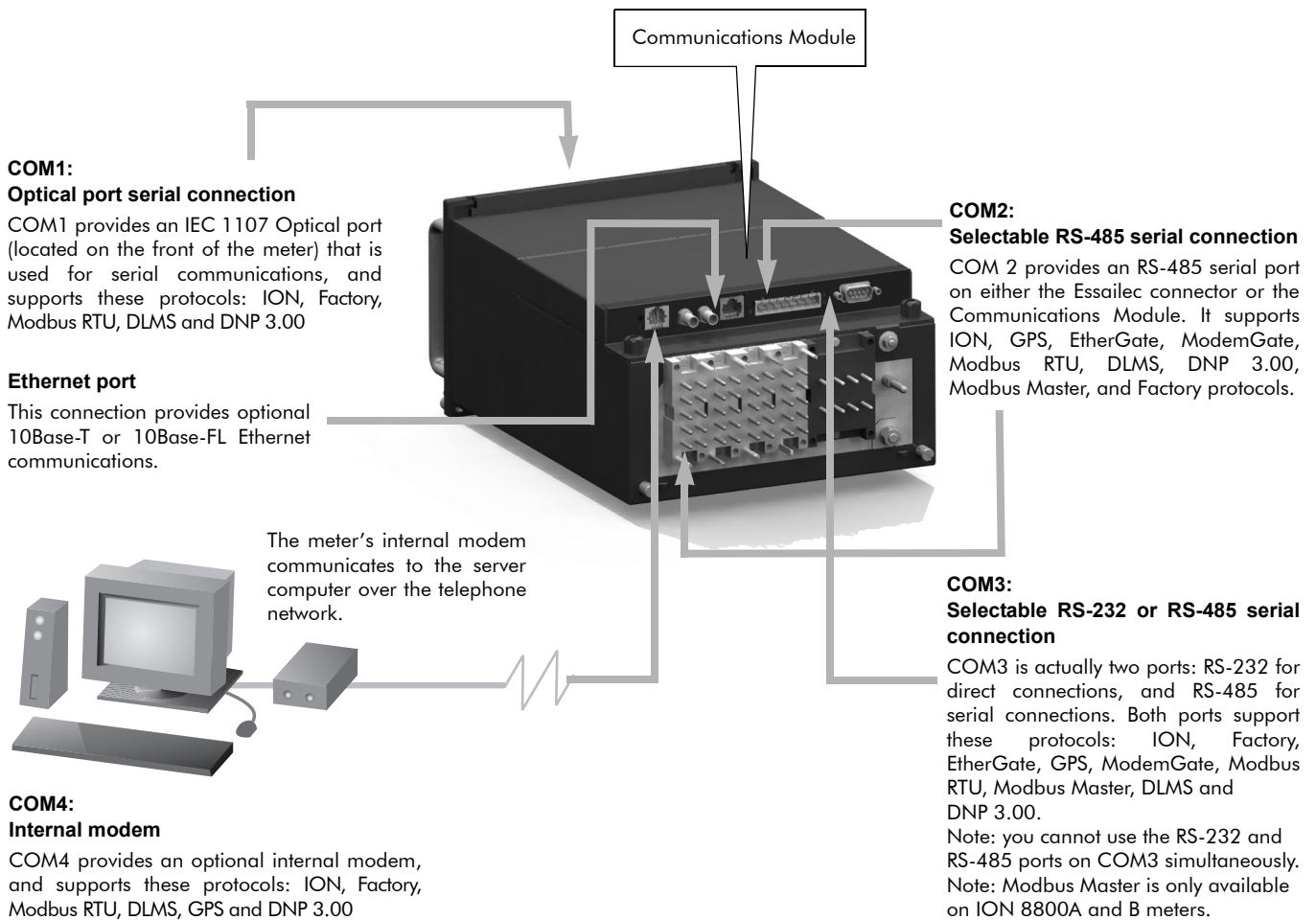

ION 8800 meters have numerous communication possibilities depending on your ordering options. See the table below for details.

COM Port	Interface Type	Meter Only	Meter with Communications Module
1	Optical	Standard	Standard
2	Selectable RS-485 (Essailec or Communications Module)	Optional	Optional
3	Selectable RS-232 or RS-485	N/A	Optional
4	Internal modem	N/A	Optional
Ethernet	Selectable Ethernet (10Base-T or -FL)	N/A	Optional

Communications Connections

The following section provides reference for connecting to the meter's various communication ports. For the most current communication specifications, see your meter's Installation Guide.

Communications connections are made to the Essailec connector and the Communication Module, both found on the rear of the meter. Optical connections are made to the port on the front of the meter. See below for details.

 **NOTE**

Meters ordered with I/O options B and C do not have RS-485 connections on the Essailec connector.

Essailec Connectors

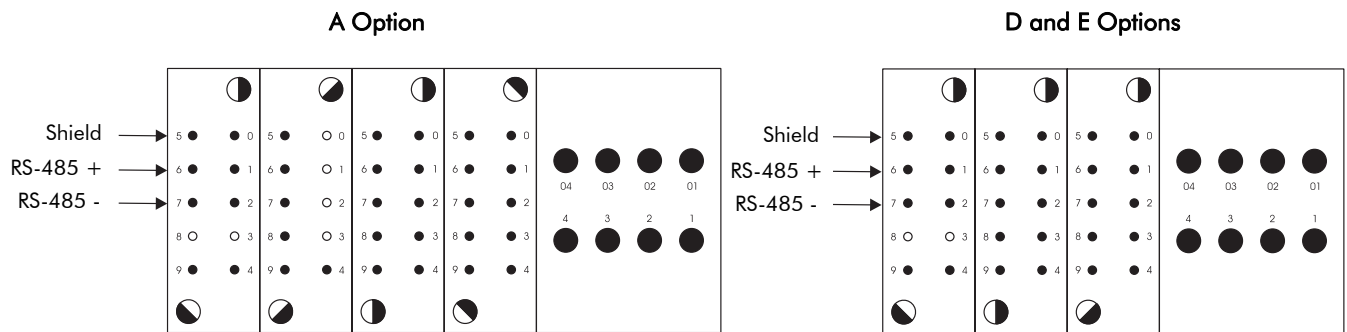

Communications Module

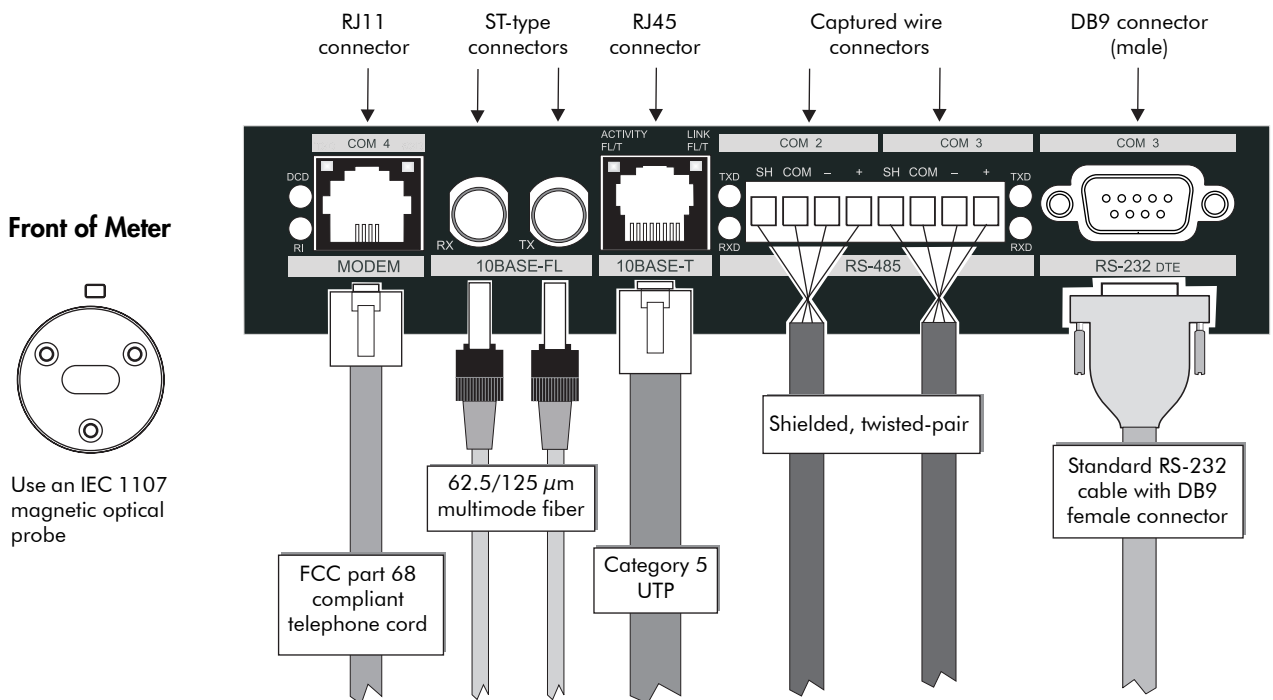

Optical Port Connections (COM1)

The front optical port is designed to accept IEC 1107 magnetic couplers. It can be used to communicate real-time measurements to a portable PC or for basic meter configuration.

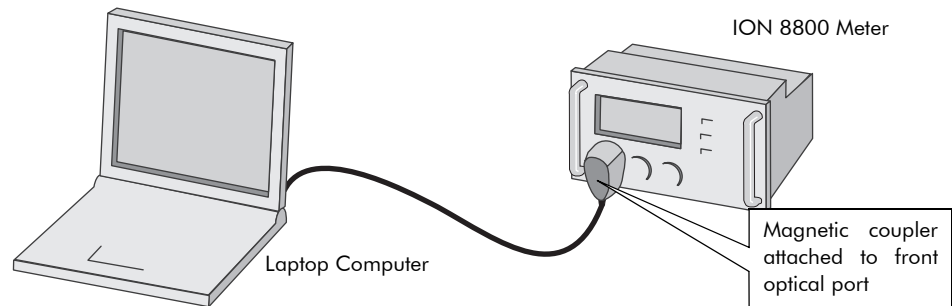

To enable communications from the optical port, configure the Comm 1 Communications module. The *Protocol*, the *Baud Rate* and *Unit ID* setup registers must properly match your system. When creating an ION site, ensure that RtsCts is disabled (set to No) in the COM1 serial site.

Refer to the Management Console section in the online *ION Enterprise Help* for more details about adding serial sites.

NOTE

To allow meter configuration via the optical port, you must ensure IR Configuration is set to Enabled. See the "ALT Config Menu" on page 36 for more information.

RS-485 Connections (COM2 and COM3)

RS-485 connections are made to the Essailec connector and the optional Communications Module, both found on the rear of the meter.

NOTE

COM2 is a selectable channel, which allows RS-485 communications via the Essailec connector OR the Communications Module. You cannot use both ports at the same time.

Up to 32 devices can be connected on a single RS-485 bus. Use a good quality shielded twisted pair cable for each RS-485 bus. The overall length of the RS-485 cable connecting all devices cannot exceed 1219 m (4000 ft.). The RS-485 bus may be configured in straight-line or loop topologies. See below for details.

Straight-Line Topology

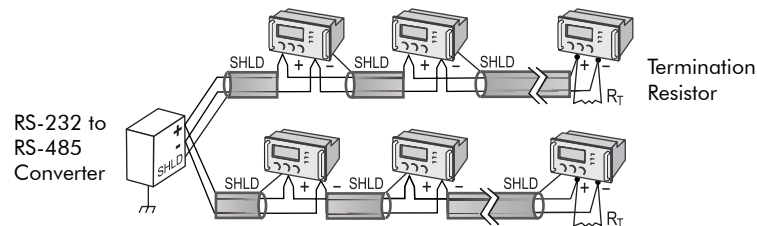

Loop Topology

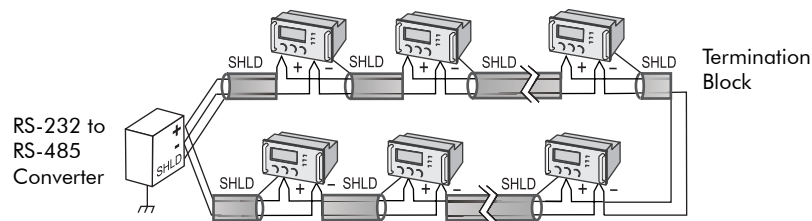

General Bus Wiring Considerations

Devices connected on the bus, including the meter, converter(s) and other instrumentation, must be wired as follows:

- ◆ Connect the shield of each segment of the cable to ground at *one end only*.
- ◆ Isolate cables as much as possible from sources of electrical noise.
- ◆ Use an intermediate terminal strip to connect each device to the bus. This allows for easy removal of a device for servicing if necessary.
- ◆ Install a ¼ Watt termination resistor (**RT**) between the (+) and (-) terminals of the device at each end point of a straight-line bus. The resistor should match the nominal impedance of the RS-485 cable (typically 120 ohms – consult the manufacturer’s documentation for the cable’s impedance value).

RS-485 Connection Methods to Avoid

Any device connection that causes a branch in the main RS-485 bus should be avoided. This includes *star* and *tee (T)* methods. These wiring methods cause signal reflections that may result in interference. At any connection point on the RS-485 bus, no more than two cables should be connected. This includes connection points on instruments, converters, and terminal strips. Following this guideline ensures that both star and tee connections are avoided.

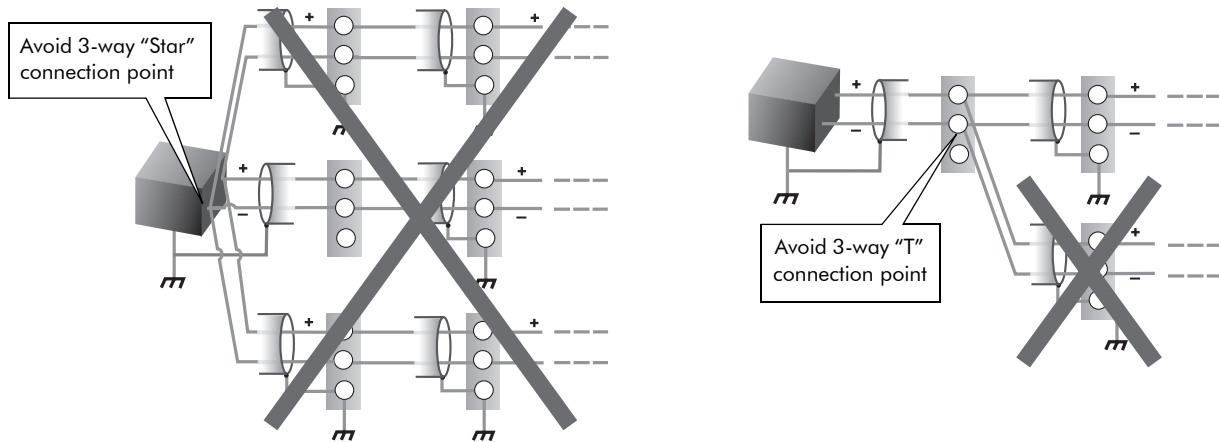

RS-232 Connections (COM3)

An RS-232 connection is made to the male DB9 connector (COM3) on the optional Communications Module, at the back of the meter. The meter acts as a DTE device in all RS-232 connections. Use a null modem cable for connecting a meter to a workstation or use a standard straight-through RS-232 cable for connecting to an external modem. In either case, one end of the cable must be equipped with DB9 female connector for mating with the meter. The maximum cable length is 15.2 m (50 feet).

 **NOTE**

For RS-232 communications, COM3 hardware mode must be set to 'RS-232'.

Computer Connections

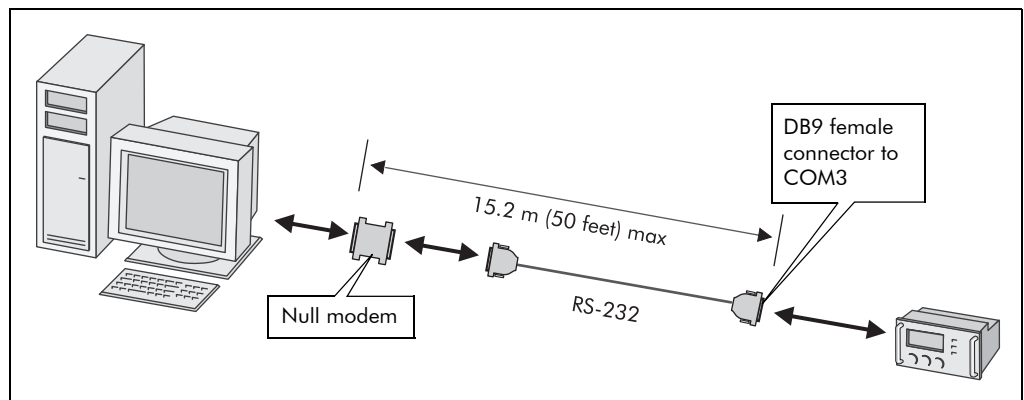

Meter Connections

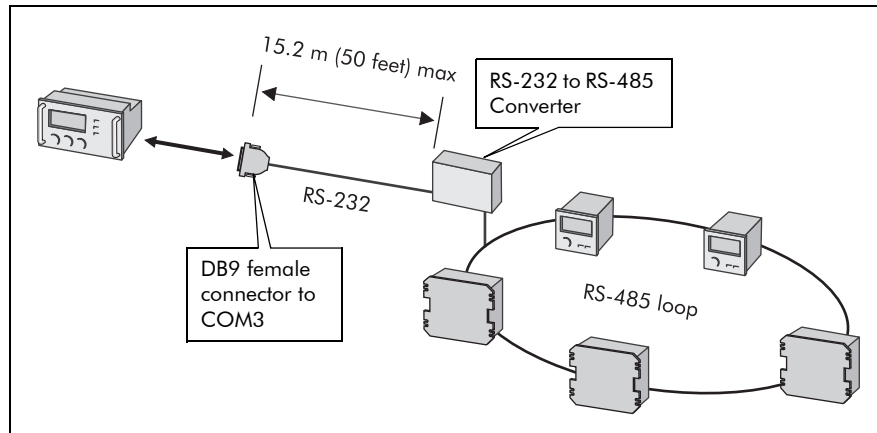

External Modem Connections

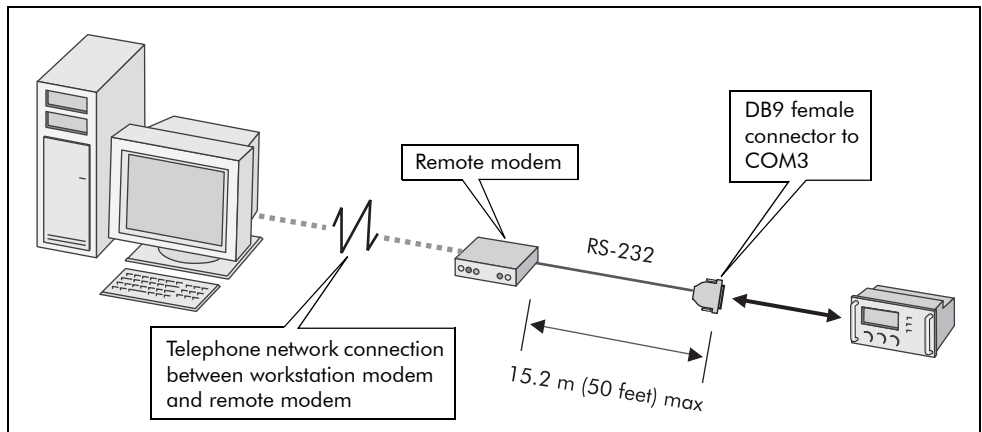

Ethernet Connections

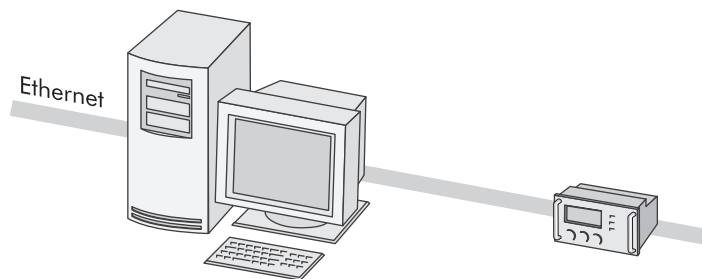

There are two Ethernet port ordering options available: a 10 Base-T port with an RJ45 modular connector or a 10 Base-FL port with two ST-type connectors. Both types of connectors plug into the Communications Module on the back of the meter. The meter supports a maximum of four simultaneous Ethernet connections.

The optional Ethernet port:

- ◆ is capable of data rates up to 10 Mbps
- ◆ supports TCP/IP, ION, Telnet, DNP 3.0 and Modbus/TCP protocols

 **NOTE**

Ethernet connection should be made to **either** the Fiber port or RJ45 port, not both, or communications conflicts may result.

The EtherGate feature provides communications both **to** an Ethernet connected device and **through** that device to a connected serial network (See the section “The EtherGate Protocol”). Only one EtherGate connection is allowed per meter port at any given time.

Internal Modem Connections (COM 4)

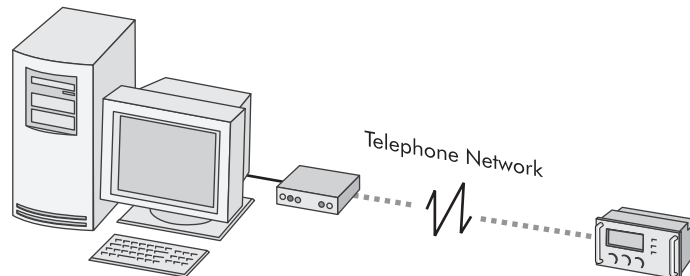

The meter’s optional internal modem is manufactured for use in most countries — refer to the Notices at the start of this document for more details.

Modem connections are made to the Communication Module on the back of the meter, via an RJ11 connector.

To enable communications through the meter’s internal modem, you must configure the Comm 4 Communications module. The *Baud Rate*, *Unit ID*, and *Protocol* setup registers must properly match your system, and the initialization string for the internal modem must be set up using the *ModemInit* register. See the section “Modem Communications Setup” for details.

Configuring Meter Communications

Communication settings are typically configured when the meter is initially put into service. A single Communications module controls each communications port on the meter. The modules' setup registers define the parameters used for each port; these parameters vary according to the type of communications channel selected (i.e. RS-232, RS-485, Modem, Optical, Ethernet).

The Communication modules control the following channels:

Module Name	Settings
Comm 1	Optical port on COM1
Comm 2	Selectable RS-485 port on COM2
Comm 3	Selectable RS-232 or RS-485 port on COM3
Comm 4	Internal modem on COM4
Ethernet	Selectable 10Base-T or 10Base-FL Ethernet port

Use the meter's front panel or ION Setup to initially configure the meter's communications. Once communication is established, Vista or Designer may also be used to make changes.



NOTE

Altering some settings of a communications channel that is in use can cause a loss of communications with the meter.

Refer to the Communications module description in the *ION Reference* for complete details about all the setup registers in the Communications module.

Communications Protocols

By default, all communication ports are configured to use the ION protocol. Using other protocols requires configuration of the *Protocol* setup register for the Communications module that controls the port you want to use. Not all protocols are available on all ports, or on all meter types.

Protocols Available - ION 8800

- ◆ ION
- ◆ Modbus RTU
- ◆ Modbus Master
- ◆ DNP 3.0
- ◆ DLMS
- ◆ GPS
- ◆ EtherGate

- ◆ ModemGate
- ◆ Factory (reserved for use by Technical Support)
- ◆ IRIG-B

Serial Communications Setup

Serial communications are available on COM1, COM2, COM3 and COM4. To enable communications through the meter's serial ports, configure the applicable Communications module. The *Protocol*, *Tran Delay*, *Baud Rate* and *Unit ID* setup registers must properly match your system and can be set through the meter's front panel or ION software.

Using the Front Panel

The current configuration of the meter's communication ports are found in the various COM Setup menu items. Ethernet settings are located under Network Setup.

Menu	Setting	Description	Range (Values)	Default
COM1	Protocol	Specifies which protocol is active	ION, Modbus RTU, DNP, DLMS, Factory	ION
	Baud Rate	Specifies COM port baud rate during serial communications	1 200 to 19 200	9 600
	Transmit Delay	Specifies the meter's transmit delay setting (in seconds)	0 to 1,0	0,010
	Unit ID	Identifies the meter during serial communications	1 to 9 999	From serial number ²
	Serial Port	Parity and stop bits for the port	8N1,8N2,8E1,8E2,8O1,8O2	8N1
COM2	Protocol	Specifies which protocol is active	ION, Modbus RTU, Modbus Master ³ , DNP, DLMS, EtherGate, ModemGate, GPS: Truetime/Datum GPS: Arbiter GPS: Arbiter/Vorne, Factory	ION
	Baud Rate ¹	Specifies COM port baud rate during serial communications	300 to 57 600	9 600
	Transmit Delay	Specifies the meter's transmit delay setting (in seconds)	0 to 1,0	0,010
	Unit ID	Identifies the meter during serial communications	1 to 9 999	From serial number ²
	Serial Port	Parity and stop bits for the port	8N1,8N2,8E1,8E2,8O1,8O2	8N1
	Port Location	Specifies physical connection point for COM2	Essailec or Comm Module	Essailec
COM3	Protocol	Specifies which protocol is active	Same as COM2	ION
	Baud Rate ¹	Specifies COM port baud rate during serial communications	300 to 115 200	9 600
	Transmit Delay	Specifies the meter's transmit delay setting (in seconds)	0 to 1,0	0,010
	Unit ID	Identifies the meter during serial communications	1 to 9999	From serial number ²
	Serial Port	Parity and stop bits for the port	8N1,8N2,8E1,8E2,8O1,8O2	8N1
	RS-232 or RS-485	Specifies RS-232 or RS-485	RS-232, RS-485	RS-232
	RTS/CTS Handshake	Specifies if hardware flow control is used during RS-232 communication	RTS with delay RTS/CTS	RTS + delay

Menu	Setting	Description	Range (Values)	Default
COM4	Protocol	Specifies which protocol is active	ION, Modbus RTU, DNP, DLMS, GPS: TrueTime/Datum GPS: Arbiter GPS: Arbiter/Vorne, Factory	ION
	Baud Rate ¹	Specifies COM port baud rate during serial communications	300 to 115 200	9 600
	Transmit Delay	Specifies the meter's transmit delay setting (in seconds)	0 to 1,0	0,010
	Unit ID	Identifies the meter during serial communications	1 to 9 999	From serial number ²

¹ 300 baud rate is only intended for paging applications.

² The factory set Unit ID is based on the serial number of the meter, using the last four numbers before the dash. For example, if the serial number is PA-0009B263-01, the Unit ID is set in the factory to 9263. After a factory reset, the unit ID number will default to 100.

³ Modbus Master is only available on ION 8800A and ION 8800B meters.

Using ION Setup

1. Open ION Setup and connect to your meter, using Basic Mode.
2. In the Setup Assistant, navigate to the Communications folder.
3. Click on the Serial Settings folder to configure serial communications.

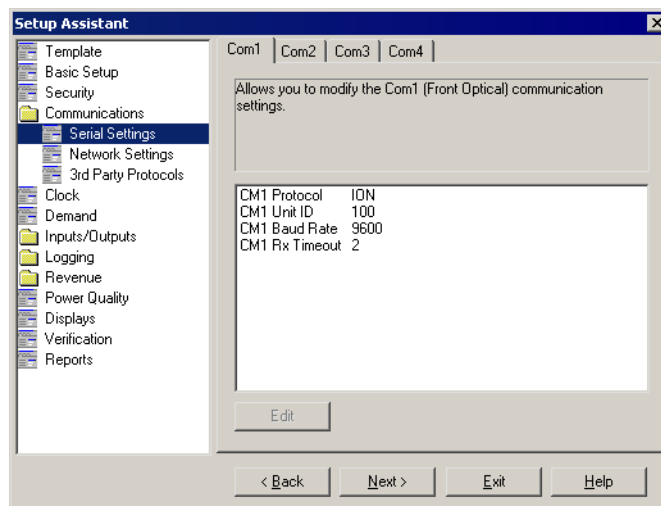

4. Click on the various tabs to configure the four serial ports (Com1, Com2, Com3 and Com4). To change a setting, select the parameter and click the Edit button.

Using Designer

Use Designer to enable serial communications on a meter port by configuring the associated Communications module.

1. Open your meter in Designer. Navigate to the Communications Setup framework.
2. Right-click the Communications module and configure the *Protocol*, *Tran Delay*, *Baud Rate* and *Unit ID* setup registers to match your system.

Ethernet Communications Setup

To enable communications through the meter's Ethernet port, configure the Ethernet Communications module. The *IP Address*, *Subnet Mask*, *Gateway*, and *SMTP Address* setup registers must properly match your system and can be set through the meter's front panel or ION software.

Using the Front Panel

The current configuration of the meter's communication ports are found in the various COM Setup menu items. Ethernet settings are located under Network Setup.

Menu	Setting	Description	Range (Values)	Default
Network Setup	IP Address	Specifies TCP/IP Ethernet address	000.000.000.000 to 255.255.255.255	None
	Mask	Specifies Subnet Mask	0.0.0.0 to 255.255.255.0	None
	Gateway	Specifies Ethernet gateway (if used)	000.000.000.000 to 255.255.255.255	None
	SMTP Address	Specifies location of SMTP Server	000.000.000.000 to 255.255.255.255	None

Use the front panel navigation buttons to edit the values of the network settings so that they match your system addresses.

As you configure the network addresses, the front panel automatically hides unnecessary leading zeroes from each three-digit grouping. The hidden leading zeroes appear (and disappear again) as you move the position of cursor across the network address.

89.123.40.056

In the example above, the highlighted zero is hidden as soon as you change the position of the cursor.

Using ION Setup

1. Open ION Setup and connect to your meter, using Basic Mode.
2. In the Setup Assistant, navigate to the Communications folder.
3. Click on the Network Settings folder to configure Ethernet communications.

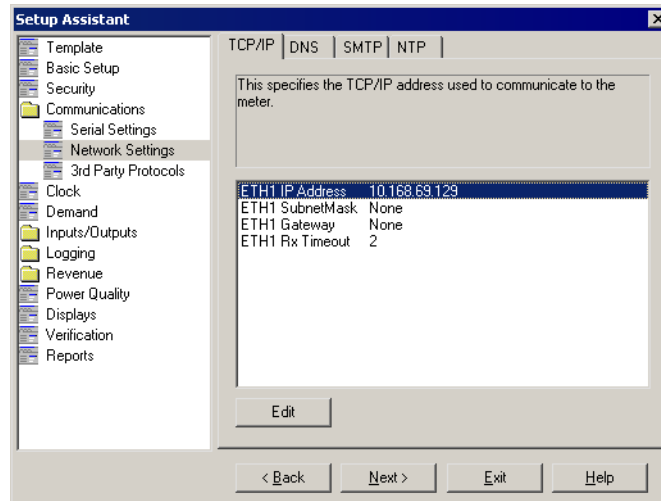

4. Click on the various tabs to configure the meter's TCP/IP, DNS, NTP and SMTP settings. To change a setting, select the parameter and click the Edit button.

Using Designer

1. Open your meter in Designer.
2. Navigate to the Communications Setup framework.
3. Right-click the Ethernet Communications module and configure the *IP Address*, *Subnet Mask*, and *Gateway* setup registers to match your system.

Meter Network Configuration and ION Enterprise

After you have wired your meter to the Ethernet network and performed basic setup, add the meter to your ION Enterprise network using the Management Console.

See the Management Console section in the online *ION Enterprise Help* for details.

The EtherGate Protocol

The EtherGate protocol is a communications tool that lets you communicate **to** a meter and **through** a meter simultaneously. When a meter installed on the Ethernet network has EtherGate enabled, a master device (such as a workstation running ION Enterprise software) can communicate to the meter, and through the meter to a serial network of devices wired to the meter's COM port. EtherGate is available on serial ports COM2 and COM3. The protocol permits the direct transfer of data from up to 62 devices (31 devices per COM port).

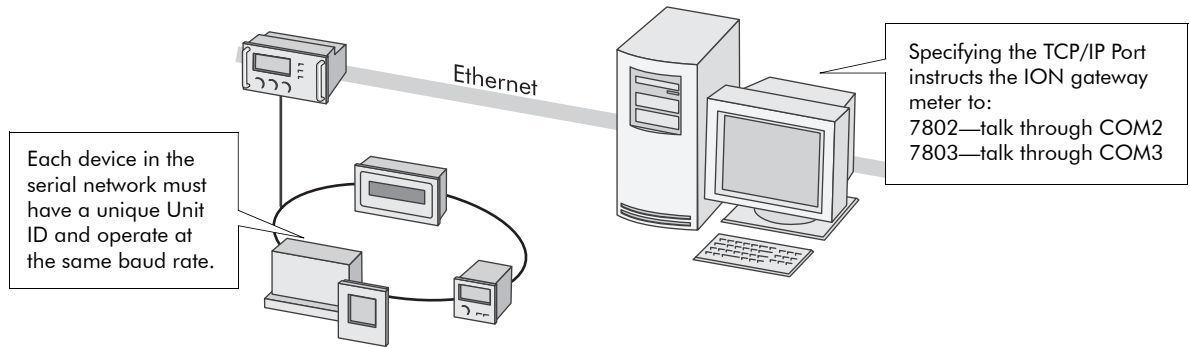

Once you have the chain of serial devices installed, use ION Setup or the meter's front panel to change the COM2 or COM3 Protocol setting to EtherGate. The transfer of data between protocols is then handled automatically.

Refer to the *ION Meter as an Ethernet Gateway* technical note for complete details on configuring your meter for EtherGate.

Modem Communications Setup

See the section “Serial Communications Setup” for configuring COM4. Additional modem configuration required is explained in the following section.

ModemInit Setup Register

The *ModemInit* string register defines the initialization string for the internal modem, with a maximum of 47 characters. Edit the *ModemInit* register and enter the initialization string desired. The string is sent to the modem as soon as you download the COM4 module. Note that the string is also sent to the modem whenever the meter is powered up, or whenever the baud rate in the Comm 4 Communications module is changed. Any changes to the *Modem Init* or *Baud Rate* setup registers while the modem is online will cause the modem to disconnect from the phone line.

Modem Initialization Strings

Refer to the technical note *Modem AT Commands* for a complete list of AT commands for your modem.

Adjusting the Modem Initialization String for CTR-21 Compliant modems

The table below shows the strings to add to the end of your modem configuration string setup register for each of three possible problems.

Problem	Add to Modem Initialization String
Does not answer (modem does not detect ring tone)	*NC70
Does not dial (modem does not detect dial tone)	In order of preference: *NC70, *NC70X0, *NC8 (Italy only)
Does not detect busy signal	*NC70

If your **local** modem (not the internal modem) is not already set up, configure it with the Remote Modem Configuration Utility according to the instructions in the online help. After the meter is installed and the internal modem is connected to the telephone network, the Comm 4 module can be configured using the meter’s front panel or ION software. To learn how to connect the internal modem to the telephone network, consult your meter’s Installation Guide.

Adding a Meter and a Modem Site to your ION Enterprise Network

In the Management Console, add the meter with the internal modem, and a modem site to your ION Enterprise network.

Consult the online *ION Enterprise Help* for details on commissioning an ION network, managing modem connections, setting up periodic dial-out, and configuring remote site event notification.

The ModemGate Protocol

The ModemGate feature creates a communications connection between the telephone network and an RS-485 serial network of devices. When you specify the protocol for a meter's COM port as MODEMGATE, all data received by the meter's internal modem is automatically transferred to the serial network. ModemGate is available on either COM2 and COM3, but you cannot use the protocol on both ports simultaneously.

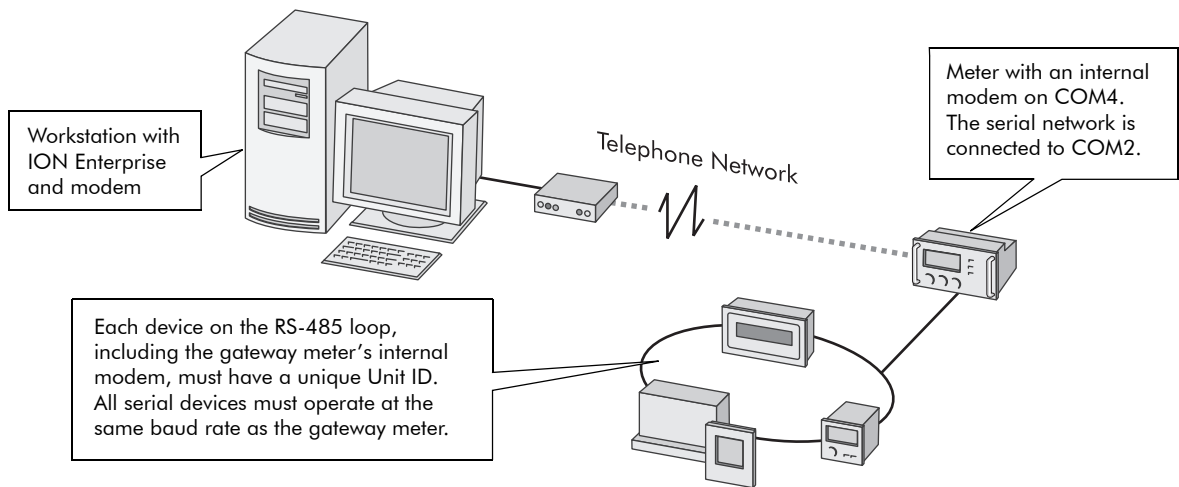

ModemGate connections do not connect a workstation with ION Enterprise (or other master device) to the gateway meter's COM2 or COM3 port, but rather the gateway meter's internal modem port (COM4).

Refer to the *ION Meter as a ModemGate* technical note for complete details on configuring your meter for ModemGate.

Internet Connectivity

Ethernet-equipped ION 8800 meters provide Internet connectivity so you can receive meter emails, view real-time data, and configure your system through a web browser from anywhere in the world. Your meter provides the following internet connectivity options:

- ◆ MeterM@il feature -- receive data logs and email alerts from the meter.
- ◆ WebMeter feature -- this onboard web server allows you to view real-time data and configure the meter through a web browser.
- ◆ Microsoft Terminal Services for ION Enterprise -- an ION Enterprise system that is located on a Terminal Server allows multiple users to view or configure an ION Enterprise system through a web browser.
- ◆ WebReach -- view Vista system information using a web browser.

WebMeter Feature

WebMeter-enabled meters have an on-board web server. Built-in web pages display certain energy and basic power quality information and also support basic meter configuration tasks. A meter with the WebMeter feature can be connected to your corporate Ethernet network like any other network device, and you can access it with a standard web browser like Internet Explorer.

Refer to the technical note *WebMeter Internal Web Server Feature* to learn how to:

- ◆ view your WebMeter data on the Internet
- ◆ configure your WebMeter-enabled meter
- ◆ set up your network for the WebMeter feature
- ◆ enable/disable web browser configuration of the meter

MeterM@il Feature

The MeterM@il feature allows your meter to send data logs as email attachments to a workstation, pager, cell phone, or PDA. In addition to the log export function, your meter can send email alerts.

Refer to the technical note *MeterM@il Internal Email Client Feature* to learn how to:

- ◆ view MeterM@il data
- ◆ set up your network for the MeterM@il feature
- ◆ configure your meter to use the MeterM@il feature
 - ◆ set up the meter for your SMTP Server
 - ◆ set up the MeterM@il feature to send alerts
 - ◆ set up the MeterM@il feature to send data logs

WebReach

The online version of Vista (WebReach) allows you to remotely view ION Enterprise information through a web browser. WebReach requires a simple URL and no client machine configuration so you have the flexibility to view your data from a web browser anywhere in the world. With WebReach, you can view real-time data and select views of historical/waveform data. Currently, no configuration or control functions are available through WebReach.

Refer to the online *ION Enterprise Help* for more details on WebReach.

Telnet and HyperTerminal

You can access certain Ethernet settings and statistics through a telnet application such as Microsoft Telnet. Similarly, you can use Windows HyperTerminal to access certain meter module settings. Use the following guidelines to determine which application you should use to access your meter:

- ◆ If your meter is connected to an Ethernet network, use a telnet application such as Microsoft Telnet.
- ◆ If your meter is connected serially or through a modem to your workstation, use a terminal application such as Windows HyperTerminal.

You can access certain Power Meter module and Factory module settings from both a Telnet session and HyperTerminal session. Additionally, a Telnet session lets you view ethernet statistics and access certain Ethernet communications module settings.

Refer to the technical note *Telnet and HyperTerminal Access* for the appropriate application's menu options and connection instructions.

Communications LEDs

The following table explains what the flashing LED lights on the back of the Communications Module signify.

LED	Color	Function
Ethernet ACTIVITY	Green ¹	Flashes as signals are transmitted and received for both Ethernet 10 Base-T and 10 Base-FL ports
Ethernet LINK	Green ¹	On as long as there is an active connection to either the 10 Base-T or 10 Base-FL ports
Internal Modem DCD	Green	Carrier Detect- Indicates the presence of a carrier signal (active connection to the modem)
Internal Modem RI	Green	Flashes to when the modem detects rings (Ring Indicator)
COM4 TRANSMIT	Red ¹	Flashes as signals are transmitted from the COM4 internal modem
COM4 RECEIVE	Red ¹	Flashes as signals are received on COM4 internal modem
COM2 TRANSMIT	Red	Flashes as signals are transmitted from the COM2 RS-485 loop
COM2 RECEIVE	Red	Flashes as signals are received on COM2 RS-485 loop
COM3 TRANSMIT	Red	Flashes as signals are transmitted from the COM3 RS-232 connection or the COM3 RS-485 loop
COM3 RECEIVE	Red	Flashes as signals are received on COM3 RS-232 connection or the COM3 RS-485 loop

¹ LED colors may differ from the standard red and green.

Chapter
7

Third-party Protocols

This chapter explains how Modbus and DNP 3.0 protocols are implemented on the meter.

For instructions on using the meter with DLMS, IRIG-B and MV-90 protocols, see the applicable technical note.

In This Chapter

◆ Overview	90
Communications Protocol Configuration	90
◆ The Meter as Modbus Slave	91
Using the Modbus RTU Protocol	91
Modbus Slave Modules	92
Using the Modbus/TCP Protocol	107
◆ The Meter as Modbus Master	108
The Factory Modbus Master Configuration	108
◆ Configuring Modbus	109
◆ Using the DNP 3.0 Protocol	112
Configuring DNP 3.0	112

Overview

All ION 8800 meters support DNP 3.0, Modbus RTU and Modbus/TCP protocols; only ION 8800A and ION 8800B meters support Modbus Mastering.

While your meter is factory configured to **send** data (acting as Modbus Slave), it is not ready to **receive** data as a Modbus Master until you set up the necessary framework. The meter is also pre-configured to **send** DNP 3.0 data to a DNP Master.

 **NOTE**

Changing the default factory third-party protocol frameworks (or creating new frameworks to enable receive functionality) is an advanced procedure. Refer to the DNP modules and Modbus modules descriptions in the *ION Reference*, as well as the technical notes *Multiprotocol DNP 3.0 and ION Technology*, and *Modbus and ION Technology* before proceeding.

Most Modbus and DNP modules on the meter are factory pre-set and only require basic configuration, such as communications setup.

 **NOTE**

Changing these modules from their factory configuration is an advanced setup procedure that requires an understanding of the protocol, as well as an understanding of the meter's internal operation. For more information on your meter and these protocols see the *Common Modbus Registers* document and the *ION 8800 DNP 3.0 Device Profile*.

Communications Protocol Configuration

In order to use the factory Modbus or DNP configuration, you must first assign the communications channel you want to use. By default, all communications ports are configured to use the ION protocol. Choose the 3rd-party protocol you want from the list of available protocols in the Communications module's Protocol setup register. See the Communications chapter for instructions.

Modbus RTU is available on each of the meter's communications ports, and multiple ports can communicate using Modbus simultaneously. Up to three ports can use the DNP 3.00 protocol at any one time.

The Meter as Modbus Slave

All ION 8800 meters can act as a Modbus Slave, using both the Modbus RTU and Modbus/TCP protocols.

Using the Modbus RTU Protocol

ION 8800 meters acting as Modbus Slave devices can make any real-time data available through the Modicon Modbus RTU protocol. Modbus Master devices connected to the meter can access (read) this data or write data to the meter's ION registers, making device configuration changes and initiating control actions.

The Factory Modbus Slave Configuration

The meter makes data available to Modbus Master devices using pre-configured Modbus Slave modules. These modules are linked to other modules in the meter that provide the energy, power and demand data. Once a communications channel is configured to use Modbus RTU protocol, the data is available to Modbus Master devices.



NOTE

Connect to TCP Service Port 7701 for Modbus RTU communications over Ethernet.
The default Modbus Unit ID of the meter over Ethernet is 100 but it can be changed to any value.

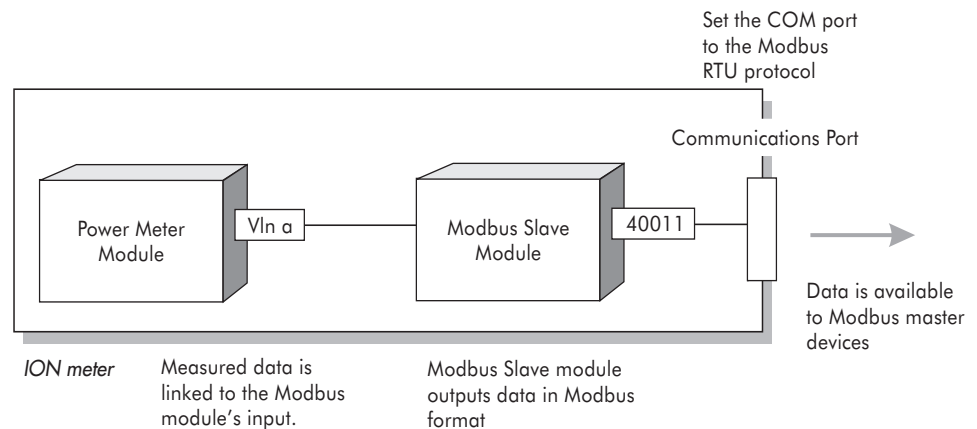

As the data available through the Modbus Slave modules is in a specific format, knowledge of the Modbus protocol and an understanding of the settings used in the meter are required to interpret the data provided.

Changing the Modbus Configuration

If the factory Modbus configuration does not suit your needs, the existing Modbus Slave modules can be relinked to other parameters that you want to access through Modbus.

If your Modbus Master device requires data in a format different than that provided by the factory Modbus configuration, you can edit the setup registers in the Modbus Slave modules. These setup registers specify the Modbus format, scaling and base address settings. Refer to the *ION Reference* for complete details on the Modbus Slave module.

Modbus Slave Modules

Your meter is pre-configured with five modules. (ION 8800 meters with the EN50160 ordering option have 11 additional modules). The settings for your Modbus Slave modules are as follows:

Amp/Freq/Unbal

Format:	unsigned 16 bit	InZero:	0
Base Address:	40150	InFull:	6,000
Scaling:	Yes	OutZero:	0
Scaling x10		OutFull:	60,000

Input	Modbus Registers	Parameter
Source #1	40150	I1
Source #2	40151	I2
Source #3	40152	I3
Source #4	40153	I4
Source #5	40154	I5
Source #6	40155	I avg
Source #7	40156	I avg mn
Source #8	40157	I avg mx
Source #9	40158	I avg mean
Source #10	40159	Freq
Source #11	40160	Freq mn
Source #12	40161	Freq mx
Source #13	40162	Freq mean
Source #14	40163	U unbal
Source #15	40164	I unbal
Source #16	40165	Phase Rev

Volts

Format:	unsigned 32 bit	InZero:	0
Base Address:	40166	InFull:	1,000,000
Scaling:	No	OutZero:	0
Scaling x10		OutFull:	10,000,000

Input	Modbus Registers	Parameter
Source #1	40166 to 40167	Uln 1
Source #2	40168 to 40169	Uln 2
Source #3	40170 to 40171	Uln 3
Source #4	40172 to 40173	Uln avg
Source #5	40174 to 40175	Uln avg mx
Source #6	40176 to 40177	
Source #7	40178 to 40179	Ull 12
Source #8	40180 to 40181	Ull 23
Source #9	40182 to 40183	Ull 31
Source #10	40184 to 40185	Ull avg
Source #11	40186 to 40187	Ull avg mx
Source #12	40188 to 40189	Ull avg mean
Source #13	40190 to 40191	
Source #14	40192 to 40193	
Source #15	40194 to 40195	
Source #16	40196 to 40197	

kW/kvar/kVA

Format:	signed 32 bit	InZero:	-1,000,000,000
Base Address:	40198	InFull:	1,000,000,000
Scaling:	No	OutZero:	-1,000,000
Scaling x0.001		OutFull:	1,000,000

Input	Modbus Registers	Parameter
Source #1	40198 to 40199	kW 1
Source #2	40200 to 40201	kW 2
Source #3	40202 to 40203	kW 3
Source #4	40204 to 40205	kW tot
Source #5	40206 to 40207	kW tot max
Source #6	40208 to 40209	kvar 1
Source #7	40210 to 40211	kvar 2
Source #8	40212 to 40213	kvar 3
Source #9	40214 to 40215	kvar tot
Source #10	40216 to 40217	kvar tot max
Source #11	40218 to 40219	kVA 1
Source #12	40220 to 40221	kVA 2
Source #13	40222 to 40223	kVA 3
Source #14	40224 to 40225	kVA tot
Source #15	40226 to 40227	kVA tot max
Source #16	40228 to 40229	

kWh/kvarh

Format:	signed 32 bit	InZero:	-1,000,000,000
Base Address:	40230	InFull:	1,000,000,000
Scaling:	No	OutZero:	-1,000,000
Scaling x0.001		OutFull:	1,000,000

Input	Modbus Registers	Parameter
Source #1	40230 to 40231	kWh del
Source #2	40232 to 40233	kWh rec
Source #3	40234 to 40235	kvarh del
Source #4	40236 to 40237	kvarh rec
Source #5	40238 to 40239	kVAh del+rec
Source #6	40240 to 40241	
Source #7	40242 to 40243	
Source #8	40244 to 40245	
Source #9	40246 to 40247	
Source #10	40248 to 40249	
Source #11	40250 to 40251	
Source #12	40252 to 40253	
Source #13	40254 to 40255	
Source #14	40256 to 40257	
Source #15	40258 to 40259	
Source #16	40260 to 40261	

PF/THD/Kfactor

Format:	signed 16 bit	InZero:	-100
Base Address:	40262	InFull:	100
Scaling:	No	OutZero:	-10,000
Scaling x100		OutFull:	10,000

Input	Modbus Registers	Parameter
Source #1	40262	PF sign 1
Source #2	40263	PF sign 2
Source #3	40264	PF sign 3
Source #4	40265	PF sign tot
Source #5	40266	U1 THD mx
Source #6	40267	U2 THD mx
Source #7	40268	U3 THD mx
Source #8	40269	I1 THD mx
Source #9	40270	I2 THD mx
Source #10	40271	I3 THD mx
Source #11	40272	I1 K Factor
Source #12	40273	I2 K Factor
Source #13	40274	I3 K Factor
Source #14	40275	I1 Crest Factor
Source #15	40276	I2 Crest Factor
Source #16	40277	I3 Crest Factor

EN50160 Module 1

This module applies to meters with the EN50160 ordering option only.

Format: *Unsigned 16 bit*

Base Address: *41000*

Scaling: *No*

Input	Modbus Registers	Parameter
Source #1	41000	PO U1-Flicker N
Source #2	41001	PO U1-Flicker N1
Source #3	41002	PO U2-Flicker N
Source #4	41003	PO U2-Flicker N1
Source #5	41004	PO U3-Flicker N
Source #6	41005	PO U3-Flicker N1
Source #7	41006	PO Freq N
Source #8	41007	PO Freq N1
Source #9	41008	PO Freq N2
Source #10	41009	PO U1-Mag N
Source #11	41010	PO U1-Mag N1
Source #12	41011	PO U2-Mag N
Source #13	41012	PO U2-Mag N1
Source #14	41013	PO U3-Mag N
Source #15	41014	PO U3-Mag N1
Source#16	41015	PO Vunbal N

PO = Observation Period

EN50160 Module 2

This module applies to meters with the EN50160 ordering option only.

Format: *Unsigned 16 bit*

Base Address: **41016**

Scaling: *No*

Input	Modbus Registers	Parameter
Source #1	41016	PO Uunbal N1
Source #2	41017	PO U1-MSignal N
Source #3	41018	PO U1-MSignal N1
Source #4	41019	PO U2-MSignal N
Source #5	41020	PO U2-MSignal N1
Source #6	41021	PO U3-MSignal N
Source #7	41022	PO U3-MSignal N1
Source #8	41023	PO U1-Harmonic N
Source #9	41024	PO U1-Harmonic N1
Source #10	41025	PO U1-Harmonic N2
Source #11	41026	PO U2-Harmonic N
Source #12	41027	PO U2-Harmonic N1
Source #13	41028	PO U2-Harmonic N2
Source #14	41029	PO U3-Harmonic N
Source #15	41030	PO U3-Harmonic N1
Source#16	41031	PO U3-Harmonic N2

PO = Observation Period, M = Mains

EN50160 Module 3

This module applies to meters with the EN50160 ordering option only.

Format: *Unsigned 16 bit*

Base Address: **41032**

Scaling: *No*

Input	Modbus Registers	Parameter
Source #1	41032	PO U1-Inthrm N
Source #2	41033	PO U1-Inthrm N1
Source #3	41034	PO U2-Inthrm N
Source #4	41035	PO U2-Inthrm N1
Source #5	41036	PO U3-Inthrm N
Source #6	41037	PO U3-Inthrm N1
Source #7	41038	PO U1-Dip N11
Source #8	41039	PO U1-Dip N12
Source #9	41040	PO U1-Dip N13
Source #10	41041	PO U1-Dip N14
Source #11	41042	PO U1-Dip N21
Source #12	41043	PO U1-Dip N22
Source #13	41044	PO U1-Dip N23
Source #14	41045	PO U1-Dip N24
Source #15	41046	PO U1-Dip N31
Source#16	41047	PO U1-Dip N32

PO = Observation Period, Inthrm = Interharmonics

EN50160 Module 4

This module applies to meters with the EN50160 ordering option only.

Format: *Unsigned 16 bit*

Base Address: **41048**

Scaling: *No*

Input	Modbus Registers	Parameter
Source #1	41048	PO U1-Dip N33
Source #2	41049	PO U1-Dip N34
Source #3	41050	PO U1-Dip N41
Source #4	41051	PO U1-Dip N42
Source #5	41052	PO U1-Dip N43
Source #6	41053	PO U1-Dip N44
Source #7	41054	PO U1-Dip N51
Source #8	41055	PO U1-Dip N52
Source #9	41056	PO U1-Dip N53
Source #10	41057	PO U1-Dip N54
Source #11	41058	PO U1-Dip N61
Source #12	41059	PO U1-Dip N62
Source #13	41060	PO U1-Dip N63
Source #14	41061	PO U1-Dip N64
Source #15	41062	PO U2-Dip N11
Source #16	41063	PO U2-Dip N12

PO = Observation Period

EN50160 Module 5

This module applies to meters with the EN50160 ordering option only.

Format: *Unsigned 16 bit*

Base Address: **41064**

Scaling: *No*

Input	Modbus Registers	Parameter
Source #1	41064	PO U2-Dip N13
Source #2	41065	PO U2-Dip N14
Source #3	41066	PO U2-Dip N21
Source #4	41067	PO U2-Dip N22
Source #5	41068	PO U2-Dip N23
Source #6	41069	PO U2-Dip N24
Source #7	41070	PO U2-Dip N31
Source #8	41071	PO U2-Dip N32
Source #9	41072	PO U2-Dip N33
Source #10	41073	PO U2-Dip N34
Source #11	41074	PO U2-Dip N41
Source #12	41075	PO U2-Dip N42
Source #13	41076	PO U2-Dip N43
Source #14	41077	PO U2-Dip N44
Source #15	41078	PO U2-Dip N51
Source#16	41079	PO U2-Dip N52

PO = Observation Period

EN50160 Module 6

This module applies to meters with the EN50160 ordering option only.

Format: *Unsigned 16 bit*

Base Address: **41080**

Scaling: *No*

Input	Modbus Registers	Parameter
Source #1	41080	PO U2-Dip N53
Source #2	41081	PO U2-Dip N54
Source #3	41082	PO U2-Dip N61
Source #4	41083	PO U2-Dip N62
Source #5	41084	PO U2-Dip N63
Source #6	41085	PO U2-Dip N64
Source #7	41086	PO U3-Dip N11
Source #8	41087	PO U3-Dip N12
Source #9	41088	PO U3-Dip N13
Source #10	41089	PO U3-Dip N14
Source #11	41090	PO U3-Dip N21
Source #12	41091	PO U3-Dip N22
Source #13	41092	PO U3-Dip N23
Source #14	41093	PO U3-Dip N24
Source #15	41094	PO U3-Dip N31
Source#16	41095	PO U3-Dip N32

PO = Observation Period

EN50160 Module 7

This module applies to meters with the EN50160 ordering option only.

Format: *Unsigned 16 bit*

Base Address: **41096**

Scaling: *No*

Input	Modbus Registers	Parameter
Source #1	41096	PO U3-Dip N33
Source #2	41097	PO U3-Dip N34
Source #3	41098	PO U3-Dip N41
Source #4	41099	PO U3-Dip N42
Source #5	41100	PO U3-Dip N43
Source #6	41101	PO U3-Dip N44
Source #7	41102	PO U3-Dip N51
Source #8	41103	PO U3-Dip N52
Source #9	41104	PO U3-Dip N53
Source #10	41105	PO U3-Dip N54
Source #11	41106	PO U3-Dip N61
Source #12	41107	PO U3-Dip N62
Source #13	41108	PO U3-Dip N63
Source #14	41109	PO U3-Dip N64
Source #15	41110	PO U1-Intrpt N1
Source#16	41111	PO U1-Intrpt N2

PO = Observation Period, Intrpt = Interruptions

EN50160 Module 8

This module applies to meters with the EN50160 ordering option only.

Format: *Unsigned 16 bit*

Base Address: *41112*

Scaling: *No*

Input	Modbus Registers	Parameter
Source #1	41112	PO U1-Intrpt N3
Source #2	41113	PO U2-Intrpt N1
Source #3	41114	PO U2-Intrpt N2
Source #4	41115	PO U2-Intrpt N3
Source #5	41116	PO U3-Intrpt N1
Source #6	41117	PO U3-Intrpt N2
Source #7	41118	PO U3-Intrpt N3
Source #8	41119	PO U1-Ovlt N11
Source #9	41120	PO U1-Ovlt N12
Source #10	41121	PO U1-Ovlt N13
Source #11	41122	PO U1-Ovlt N14
Source #12	41123	PO U1-Ovlt N15
Source #13	41124	PO U1-Ovlt N21
Source #14	41125	PO U1-Ovlt N22
Source #15	41126	PO U1-Ovlt N23
Source #16	41127	PO U1-Ovlt N24

PO = Observation Period, Ovlt = Over Voltage, Intrpt = Interruption

EN50160 Module 9

This module applies to meters with the EN50160 ordering option only.

Format: *Unsigned 16 bit*

Base Address: *41128*

Scaling: *No*

Input	Modbus Registers	Parameter
Source #1	41128	PO U1-Ovlt N25
Source #2	41129	PO U1-Ovlt N31
Source #3	41130	PO U1-Ovlt N32
Source #4	41131	PO U1-Ovlt N33
Source #5	41132	PO U1-Ovlt N34
Source #6	41133	PO U1-Ovlt N35
Source #7	41134	PO U2-Ovlt N11
Source #8	41135	PO U2-Ovlt N12
Source #9	41136	PO U2-Ovlt N13
Source #10	41137	PO U2-Ovlt N14
Source #11	41138	PO U2-Ovlt N15
Source #12	41139	PO U2-Ovlt N21
Source #13	41140	PO U2-Ovlt N22
Source #14	41141	PO U2-Ovlt N23
Source #15	41142	PO U2-Ovlt N24
Source#16	41143	PO U2-Ovlt N25

PO = Observation Period, Ovlt = Over Voltage

EN50160 Module 10

This module applies to meters with the EN50160 ordering option only.

Format: *Unsigned 16 bit*

Base Address: **41144**

Scaling: *No*

Input	Modbus Registers	Parameter
Source #1	41144	PO U2-Ovlt N31
Source #2	41145	PO U2-Ovlt N32
Source #3	41146	PO U2-Ovlt N33
Source #4	41147	PO U2-Ovlt N34
Source #5	41148	PO U2-Ovlt N35
Source #6	41149	PO U3-Ovlt N11
Source #7	41150	PO U3-Ovlt N12
Source #8	41151	PO U3-Ovlt N13
Source #9	41152	PO U3-Ovlt N14
Source #10	41153	PO U3-Ovlt N15
Source #11	41154	PO U3-Ovlt N21
Source #12	41155	PO U3-Ovlt N22
Source #13	41156	PO U3-Ovlt N23
Source #14	41157	PO U3-Ovlt N24
Source #15	41158	PO U3-Ovlt N25
Source #16	41159	PO U3-Ovlt N31

PO = Observation Period, Ovlt = Over Voltage

EN50160 Module 11

This module applies to meters with the EN50160 ordering option only.

Format: *Unsigned 16 bit*

Base Address: **41160**

Scaling: *No*

Input	Modbus Registers	Parameter
Source #1	41160	PO U3-Ovlt N32
Source #2	41161	PO U3-Ovlt N33
Source #3	41162	PO U3-Ovlt N34
Source #4	41163	PO U3-Ovlt N35

PO = Observation Period, Ovlt = Over Voltage

Importing Data using Modbus RTU

It is possible to bring data into the meter using Modbus. Various ION registers can be written by Modbus Master devices by correlating the Modbus register number with the address of the ION register you want to write. When a Modbus register is written with a value, the corresponding ION register will be written, provided the Modbus RTU protocol is active on the communications channel that connects the Modbus Master to the meter.

You can use the Modbus RTU protocol to write values into ION external numeric, pulse and Boolean registers, allowing you to enable, disable and reset meter functions. You can also use the Modbus protocol to change setup register values in various ION modules to configure the meter's operation. To bring data into the meter with Modbus RTU, you must disable the meter's password security.

Using the Modbus/TCP Protocol

Modbus/TCP is the newest open Modbus protocol variant (formerly called MBAP). It defines the packet structure and connection port (port 502) for the industry standard TCP/IP protocol. The structure of Modbus/TCP is very similar to the Modbus RTU packet except that it has an extra six-byte header and does not use the cyclic redundancy check (CRC). Modbus/TCP retains the Modbus RTU limit of 256 bytes to a packet.

Modbus TCP Communications

You can communicate to the meter using Modbus TCP (formerly called MBAP). Your meter must have the optional Ethernet port. Connect to socket **502**.

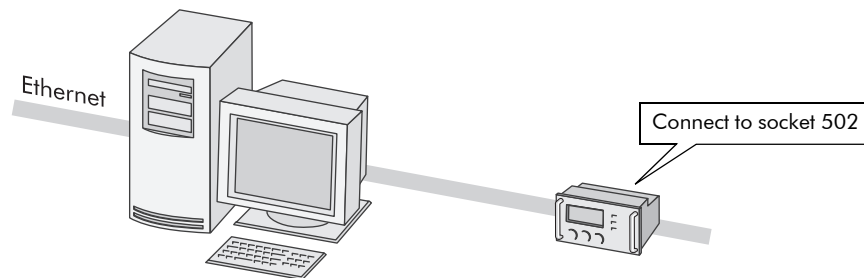

NOTE

You cannot make an EtherGate connection to the Modbus TCP network.

The Meter as Modbus Master

ION 8800A and ION 8800B meters can act as a Modbus Master using the Modbus RTU and Modbus/TCP protocols. However, only serial connections are supported between the ION 8800 meter and the Modbus Slave devices.

The ION meter acting as Modbus Master can write data to (export), and read data from (import) Modbus Slave devices, using various ION modules. The data can be processed by the meter and sent out using other communications methods (email, ION software, etc.). The meter can also send control commands or data directly to other devices on a Modbus network.

The Factory Modbus Master Configuration

There is no pre-configured framework for Modbus mastering on your meter. Your meter's template contains the following modules but they must first be added, enabled and configured in a framework before full functionality is possible.

ION Modules for Modbus Mastering

Several ION modules work together to create Modbus mastering functionality on the meter. Your meter will have some or all of these modules, depending on the model and firmware version. See the *ION Reference* for more information on these and other ION modules:

- ◆ **Modbus Master Device Module:** provides read functionality when used in conjunction with the Modbus Master Map module. This imported data can be used by other ION modules.
- ◆ **Modbus Master Map Module:** provides a common place to hold setup information for decoding a Modbus response. This information can be used by multiple Modbus Master Device modules.
- ◆ **Modbus Master Options Module:** maps any serial connection from the Modbus Import and Modbus Export modules to any serial communications port.
- ◆ **Modbus Export Module:** provides write functionality.
- ◆ **Modbus Import Module:** provides read functionality. This data can then be used by other ION modules.

See the *Modbus and ION Technology* technical for more information on configuring Modbus mastering.

Configuring Modbus

Using the Front Panel

You cannot configure Modbus through the meter's front panel. You can only assign the Modbus protocol to communication ports. See the Communications chapter for details.

Using ION Setup

The Modbus Setup Assistant helps you configure both Modbus Master and Slave functionality for your meter.

1. Open ION Setup and connect to your meter, using Basic Mode.
2. In the Setup Assistant, navigate to Communications > 3rd Party Protocols
3. Click on the Modbus Slave tab to edit the Modbus Slave modules.
4. Select the map name (in this example, the default map) and click Edit.

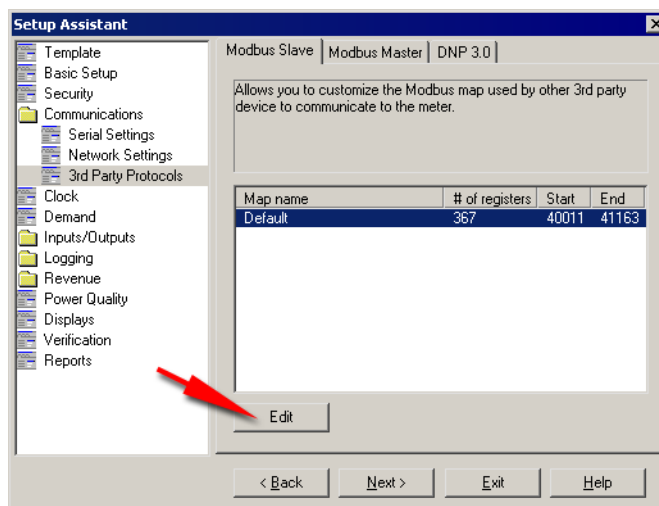

5. The default Modbus map editor appears, allowing you to edit, add, delete or set the name of Modbus Slave module registers.

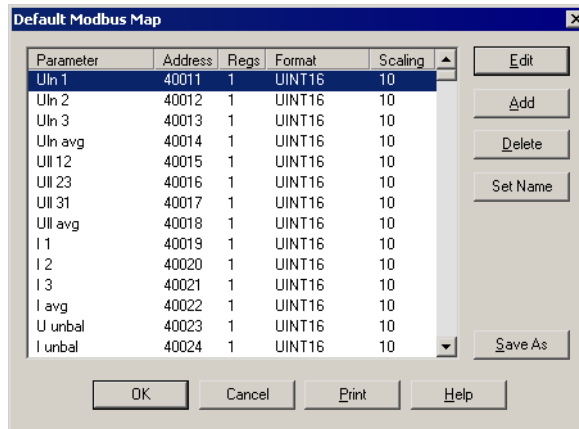

6. Click on the Modbus Master tab.
7. Click the Add button to add a Modbus Slave device.

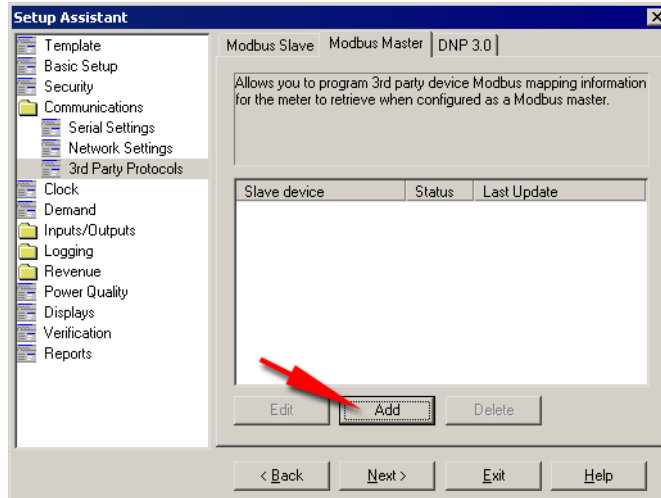

8. The Modbus Device screen appears. Enter the Slave device's name, a label suffix and select a device type (in this example, an ION 6200).

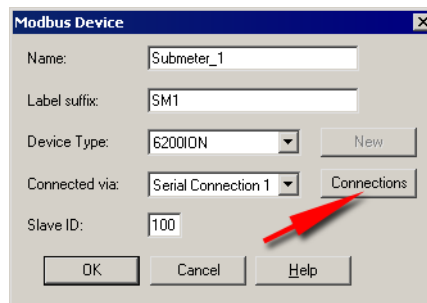

9. Click the Connections button to edit the serial connection used by the Modbus Master to connect to this Slave device. Note that the ION 8800 meter currently does not support downstream TCP connections for Modbus mastering.

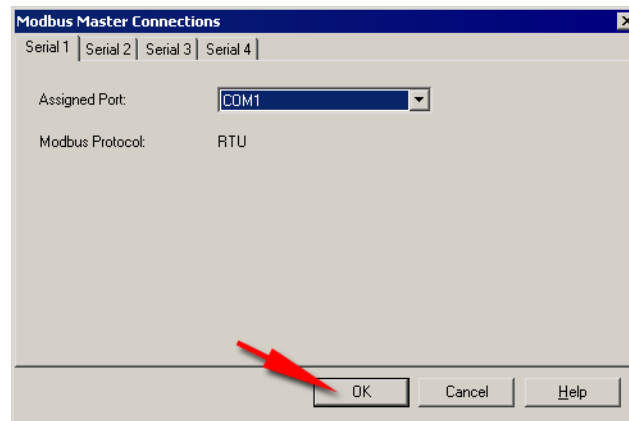

Select a communications port from the Assigned Port drop-down list and click OK.

10. Click OK to add the Slave device. The device now appears in the list. Continue adding devices and click Exit when you are finished.

See the *Modbus and ION Technology* technical note for more information.

Using the DNP 3.0 Protocol

The Distributed Network Protocol Version 3.0 (DNP 3.0) is an open protocol used in the electric utility industry for communications and interoperability among substation computers, Remote Terminal Units (RTUs), Intelligent Electronic Devices (IEDs, e.g. meters), and Master Stations.

The ION 8800 meter can be integrated into a DNP network as a DNP Slave, using the DNP Slave Import, DNP Slave Export and DNP Slave Options modules. For more information on the various DNP modules, see the *ION Reference*.

Your meter supports a maximum of three concurrent connections (or “sessions”) using the DNP 3.0 protocol; one for each serial port, up to three using Ethernet, or a combination of both. Combinations available will depend on the meter's communications options. A session consists of all incoming and outgoing DNP Master/Slave traffic on one of the meter's communications ports.

Consult the DNP User's Group at <http://www.dnp.org/> to learn more about the protocol.

The Factory DNP 3.0 Configuration

Your meter is pre-configured with a DNP framework that allows for basic DNP Slave functionality. DNP Slave Export modules are used to send data to the DNP Master while DNP Slave Options modules provide per-session settings such as communications options. Although some minor setup of the framework is necessary before it becomes enabled (assigning the DNP protocol to the communications ports etc.), most module settings should not require alteration.

For information on your meter's default DNP map and factory configuration, see the *ION 8800 DNP 3.0 Device Profile*.

Importing Data using DNP 3.0

Data can be imported into the meter from a DNP control relay or analog output device. DNP Slave Import modules are used to take a DNP Analog output or Binary output object and map them into ION registers.

NOTE

DNP Slave Import modules are not part of the factory DNP framework and must be added manually. Refer to the DNP Slave Import module description in the *ION Reference* for details.

Configuring DNP 3.0

If the factory DNP configuration does not suit your needs, you can relink the existing DNP Slave Export modules to access a different set of parameters through DNP. Alternately, you can add additional DNP Slave Export modules and link the desired ION parameters to them.

If your DNP network requires data in a format different than that provided by the factory DNP configuration, you can edit the setup registers in the DNP Slave Export modules and the DNP Slave Options modules. Do not make any changes to the DNP Slave Options modules' setup registers unless you understand the effects each change will cause. Refer to the *ION Reference* for complete details on DNP Slave Export and DNP Slave Options module function.

For detailed information on configuring your meter to use DNP, see the *Multiport DNP and ION Technology* technical note.

Using the Front Panel

You cannot configure DNP through the meter's front panel. You can only assign the DNP 3.0 protocol to communication ports. See the Communications chapter.

Using ION Setup

The DNP 3.0 Setup Assistant helps you configure the DNP Slave Export and DNP Slave Options modules.

1. Open ION Setup and connect to your meter, using Basic Mode.
2. In the Setup Assistant, navigate to Communications > 3rd Party Protocols and click on the DNP 3.0 tab.
3. Select the DNP feature you wish to configure (Parameter Map in this example) and click Edit.

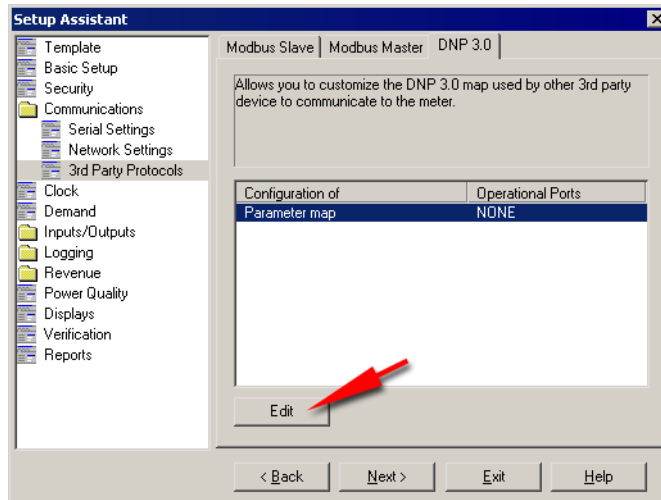

4. The Setup Assistant guides you through DNP configuration. See the *ION Setup Online Help* for more information.

Chapter 8

Time

This chapter covers the meter's clock and time synchronization.

In This Chapter

◆ Meter Clock Configuration	116
Configuring the Meter Clock	116
Using the Front Panel	116
Using ION Setup	116
Using Designer	117
Clock Module Settings	117
◆ Meter Battery	118
◆ Time Synchronization	119

Meter Clock Configuration

The Clock module controls the meter's internal clock, which provides timestamps for data logged by the device. The clock needs to be configured properly to ensure that logged data has accurate timestamp information. The Clock module also receives the time synchronization signals sent to it by the workstation running ION software, updating the device's clock when required.

The Clock module's *Clock Source* setup register defines how the meter's internal clock auto-corrects drift from its internally calculated time. A separate time source (such as a GPS receiver, or a DNP Master) can be used to synchronize the clock through a communications channel. By default, the clock is set to synchronize from the line frequency.

See the *ION Reference* for more information on the Clock module.

Configuring the Meter Clock

Use ION software to change the meter's clock settings.

Using the Front Panel

You cannot configure the time via the meter's front panel.

Using ION Setup

The Clock Setup Assistant helps you configure the Clock module.

1. Open ION Setup and connect to your meter, using Basic Mode.
2. In the Setup Assistant, navigate to the Clock folder.

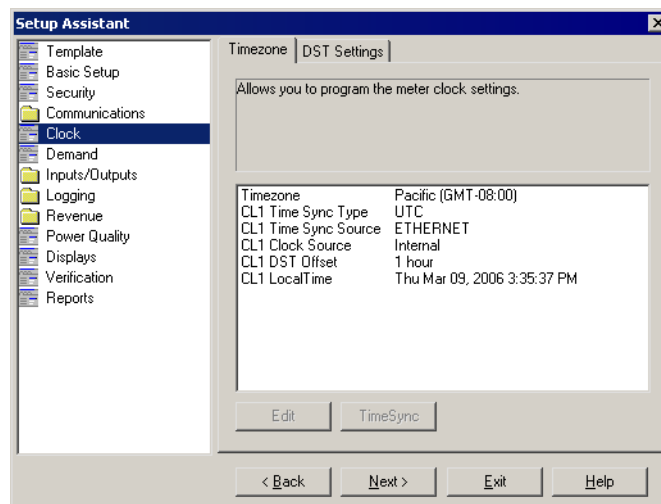

3. Click on the Timezone tab to configure your meter's clock settings. Select a parameter and click Edit to change.

- Click on the DST Settings tab to configure your meter's daylight savings periods for up to 20 years. Select a parameter and click Edit to change.

Using Designer

Open your meter in Designer and navigate to the Meter Clock Setup framework. Right-click on the Clock module to edit.

Clock Module Settings

The setup registers in the Clock module specify timezone and Daylight Savings Time (DST) parameters and time synchronization functions.

Setup Register	Function	Default
TZ Offset	Sets the timezone the device is in, relative to Greenwich Mean Time.	0
DST Start 1 ... DST Start 20	The date and time when DST begins for 20 separate years.	See below
DST End ... DST End 20	The date and time when DST ends for 20 separate years.	
DST Offset	The amount of time the clock is changed when DST begins or ends.	3, 600 seconds
Time Sync Source	Specifies the communications port that receives time sync signals.	COM1
Time Sync Type	Specifies the type of time sync signal (Local or Universal time).	UTC
Clock Source	Specifies the clock's time synchronization signal source (line frequency, communications signals, or internal crystal).	Internal



TIP

When modifying setup registers of the Clock module in Designer, use the Format option to convert between UNIX and conventional time. Refer to the description of the Clock module in the online *ION Reference* for more details.

Typically, the *DST Start* and *DST End* registers do not have to be reconfigured. The factory defaults are the DST start and end dates for 20 years, in UNIX time (the number of seconds since 00:00:00 UTC on Jan. 1, 1970).

Refer to the technical note *Time Synchronization and Timekeeping* for further details on using the meter's time synchronization functions.

Meter Battery

The battery in the ION 8800 meter keeps the real time clock running when supply power is lost. Replace the battery if the meter has been stored for an extended period of time without power (longer than two years). If the meter will be without power for an extended length of time, disconnect the battery cable so that the battery maintains its 10-year shelf life.

For more information on replacing the meter battery, see the *ION 8800 Field Retrofit Guide*.

Event Screen/Event Log confirmation (Unpowered Meter)

On an unpowered meter, the battery powers the internal clock. Removing the old battery effectively stops the meter's clock until the battery is replaced. Once replaced, the clock restarts at its last known power-down time. The ION 8800 logs this as an event, which can be viewed from the Event Log on the meter's front panel (see "ALT mode default display screens" on page 176 for details on navigating to the Event Screen). The Event Log appears as the following screen:

DATE	TIME	EVENT	CODE
12/08/2005	10:23:45	Internal Error	PWRMAN: 600
12/08/2005	10:42:03	Information	450
9:36:54	12/09/2005	Q1 ALT	■ 13m

NOTE

Error codes are written at the time of power up, as indicated by their ION event timestamp

The meter records the following event codes after battery replacement on an unpowered meter:

Error Code	Explanation	Recommended Action
450	Seen only in combination with a '600' event.	Refer to 600, below.
600	Loss of up to 10 minutes of billing data and time late by as much as 10 minutes	Connect to the meter with ION software and synchronize the meter's internal clock. See "Configuring the Meter Clock" on page 116 for details. Double-check battery installation (if required).

For details on resetting the meter's internal clock, see "Configuring the Meter Clock" on page 116.

Time Synchronization

Time synchronization lets you synchronize your meter's internal clock with all of the other meters, devices, and software in a network. Once synchronized, all data logs have timestamps that are relative to a uniform time base. This allows you to achieve precise sequence-of-events and power quality analyses. Use ION software to broadcast time signals across the network, or utilize an external source (such as an NTP server or DNP Master) to synchronize your meter's clock.

Refer to the technical note *Time Synchronization & Timekeeping* for more information on implementing time synchronization.

For meters with the IRIG-B ordering option, consult the *IRIG-B GPS Time Synchronization* document that came with your meter.

Chapter
9

Demand

This chapter explains how to configure and view demand values on your meter.

In This Chapter

◆ Introduction	122
◆ Configuring Demand	122
Using the Front Panel	122
Using ION Setup	122
Using Designer	123
Sliding Window Demand Module Settings	123
◆ Demand Forgiveness	124
Additional Information	126
Configuring Demand Forgiveness	127
Using the Front Panel	127
Using ION Setup	127

Introduction

Demand is a measure of average power consumption over a fixed time interval. Peak (or maximum) demand is the highest demand level recorded over the billing period. Sliding Window Demand modules are configured to calculate the average current demand and kW, kvar and kVA demand. The setup registers in the demand modules define time intervals for demand calculations, setting the sensitivity of the module's operation.

See the *ION Reference* for more information about these modules.

Configuring Demand

Use the front panel or ION software to change your meter's demand settings.

Using the Front Panel

1. Press and hold the **Alt/Enter** button for a few seconds to access the Setup Menu.
2. Scroll using the **Up** or **Down** arrow buttons to select Demand Setup. Press the **Alt/Enter** button to access the Demand Setup menu.

Menu	Setting	Description	Range (Values)	Default
Demand	SWD Subinterval	Intervals used to compute your Sliding Window Demand values	1 to 5 940	600
	SWD # Subintervals	The number of SWD periods in use	1 to 15	3
	SWD Pred Resp	The speed of the predicted demand output	0,00 to 99,00	70

3. Scroll to the desired parameters using the **Up** or **Down** arrow buttons. Press the **Alt/Enter** button to access each parameter.

Use the **Up** or **Down** buttons to edit the value of each parameter.

NOTE

You may be prompted for the meter's password the first time you attempt to change any values.

4. Select Yes to confirm the change.

Using ION Setup

The Demand Setup Assistant helps you configure Sliding Window Demand. This screen also contains two registers used for configuring Sliding Window Demand while the meter is in TEST mode.

1. Open ION Setup and connect to your meter, using Basic Mode.
2. In the Setup Assistant, navigate to the Demand folder.

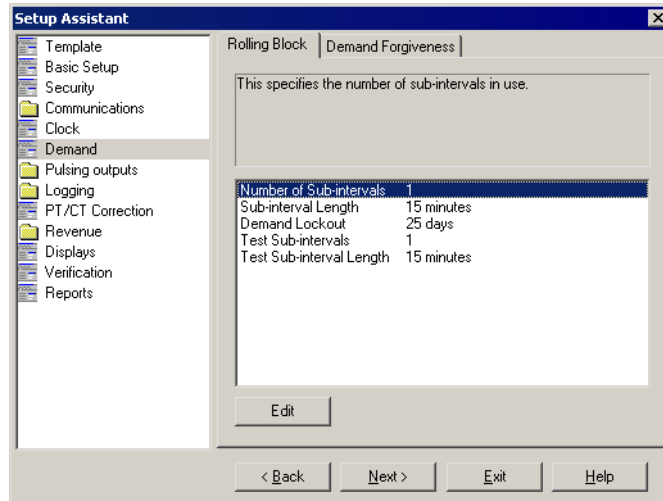

3. Configure Rolling Block demand by selecting a register and clicking Edit.

Using Designer

Open your meter in Designer and navigate to the Demand Setup framework. Right-click on a Sliding Window Demand module to edit.

For Time-of-Use Demand setup, navigate to the Time-of-Use Framework folder.

Sliding Window Demand Module Settings

Sliding Window Demand is often referred to as Rolling Block Demand. To compute sliding window demand values, the Sliding Window Demand module uses the sliding window averaging (or rolling interval) technique which divides the demand interval into sub-intervals.

The demand is measured electronically based on the average load level over the most recent set of sub-intervals. This method offers better response time than fixed interval methods.

Setup Register	Function	Default
Sub Intvl	The time, in seconds, in the sliding window demand sub-interval.	varies
#SubIntvls	The number of sub-intervals in the sliding window.	3
Pred Resp	The speed of Predicted Demand calculations; use higher values for faster prediction (70 to 99 recommended).	70
Update Rate	Defines the update rate of the <i>SWinDemand</i> output register	End of Sub-Interval

Demand Forgiveness

Demand Forgiveness is the time programmed to the meter during which demand (and therefore peak demand) will not be calculated in the power restoration period following a total power outage.

During power-up following a complete power outage, customer equipment consumes a higher than normal amount of power. The Demand Forgiveness feature lets a utility forgive the customer for peak demand penalties that may arise from power-up following a power outage (should the outage exceed a user-specified period of time).

Demand and Peak Demand Module Overview

Power utilities generally bill commercial customers based on their peak usage levels, called *peak demand* (in kW), and *energy consumption* (in kWh). Demand is a measure of average power consumption over a fixed time interval, typically 15 minutes. Peak (or maximum) demand is the highest demand level recorded over the billing period. *Sliding window/rolling block demand* is one method of measuring demand.

To compute sliding window demand values, the Sliding Window/Rolling Block Demand module uses the *sliding window averaging* (or *rolling interval*) technique which divides the demand interval into sub-intervals. The demand is measured electronically based on the average load level over the most recent set of sub-intervals.

In the following diagram, the Sliding Window/Rolling Block module labeled "Demand" calculates demand from the power input by measuring and averaging the power over a set interval. The demand value is then output to a Maximum module labeled "Peak Demand" that records the highest demand value over time (peak demand).

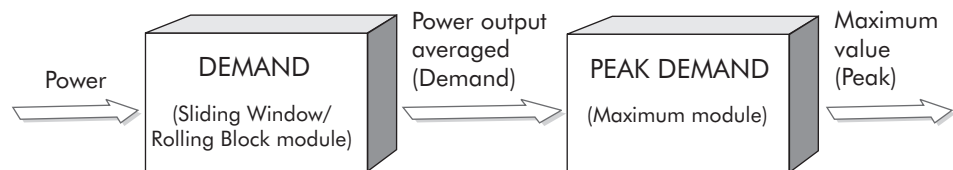

For information on ION modules, refer to the online *ION Reference*.

Demand and Peak Demand Module Behavior During Demand Forgiveness

A peak demand value is the highest demand value since the last peak demand reset. The Demand Forgiveness framework sets the Sliding Window/Rolling Block module inputs to zero during a Demand Forgiveness period. This method allows demand interval data to accurately reflect a complete interval that includes data:

- ◆ prior to an outage
- ◆ during the Demand Forgiveness period (zero values)
- ◆ after the Demand Forgiveness period

NOTE

During a Demand Forgiveness period, Demand module inputs are set to zero and do not reflect actual demand. *These values should not be used to calculate energy for billing purposes.* Energy values are not affected and will reflect actual energy consumption during the Demand Forgiveness period.

The settings listed below must be made for Demand Forgiveness functionality. These settings can be accessed from ION Setup software; refer to “Using ION Setup” on page 127.

- ◆ *Minimum Outage Duration* lets you specify the amount of time (in seconds) that the power must be out before the Demand Forgiveness period begins.
- ◆ *Demand Forgiveness Duration* lets you specify the amount of time (in seconds) that demand is forgiven (demand inputs are zero).
- ◆ *Update Rate* lets you define the update rate of the *SWinDemand* output register and is set to EVERY SECOND by default for revenue-related demand modules. With this setting, demand value measured is updated once per second.
- ◆ *Outage Voltage* (line-to-line average in unscaled meter units) lets you define a voltage level that is considered an outage. This is set to 20 volts by default.

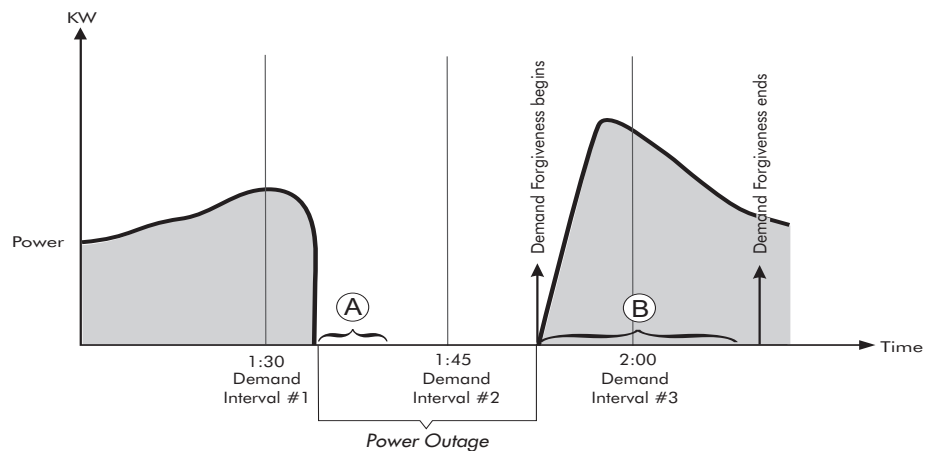

- Ⓐ The specified amount of time that the power must be out before demand is forgiven
- Ⓑ The specified amount of time that demand is delayed during the Demand Forgiveness period

The preceding diagram shows an example of a meter that is set up for Demand Forgiveness. The Sliding Window/Rolling Block Demand module is averaging demand values at 15 minute intervals. During interval #1, the meter has a power outage that lasts for 18 minutes. The power outage is defined by a system voltage of 20 volts which has been specified in the *Outage Voltage* setting. The *Minimum Outage Duration* setting is specified as 10 minutes, so this is amount of time that the power must be out before demand can be forgiven. The *Demand Forgiveness Duration* setting is specified as 1800 seconds (30 minutes), so for 30 minutes following power restoration, demand inputs are zero. The power is restored during interval #2, where the surge of power consumption during power-up is included in the Demand Forgiveness period and has a value of zero.

Additional Information

The following points are important to note:

- ◆ The following demand input values are zero for kQ, kW, kVA, and kvar during the Demand Forgiveness period:
 - ◆ Delivered
 - ◆ Received
 - ◆ Delivered + received
 - ◆ Delivered – received
 - ◆ Q1, Q2, Q3, Q4
- ◆ If a new peak is set prior to a power outage, it will persist.
- ◆ Even though demand is zero during the Demand Forgiveness period, a new peak could be set if the demand was very high prior to the power outage, or after the Demand Forgiveness period ends.
- ◆ Demand Forgiveness works for both single-phase and 3-phase powered meters.
- ◆ All ION modules in the Demand Forgiveness framework are fully locked.
- ◆ If a Demand Forgiveness period is initiated, and another power outage occurs that is less than the time specified in the *Minimum Outage Duration* setting, then the Demand Forgiveness period continues. If a second outage is greater than the time specified in the *Minimum Outage Duration* setting, then the Demand Forgiveness period restarts.
- ◆ Both the power outage downtime and the Demand Forgiveness downtime are stored within the Demand Forgiveness framework. The Store modules preserve a timestamp that is viewable in Vista.
- ◆ The Sliding Window/Rolling Block demand module *Update Rate* setup register must be set to EVERY SECOND (default).
- ◆ If Demand Forgiveness is enabled on a single-phase powered meter and there is no power from the line, then the meter assumes that this is an outage. When power is applied from the line again, demand is forgiven for the specified time.
- ◆ If Demand Forgiveness is enabled and the meter is unplugged for servicing or other reasons, then the Demand Forgiveness framework assumes there was an outage and demand is forgiven for the specified time.
- ◆ For meters where Demand Forgiveness is enabled at the factory (e.g. RMICAN Canadian revenue meters), demand will not be measured when the meter is first put into service. Instead demand is forgiven for the specified time.

Configuring Demand Forgiveness

Demand Forgiveness is disabled by default. To enable Demand Forgiveness, use ION Setup software to set the:

- ◆ External Boolean module named “Demand Forgiveness Enable” to ENABLE.
- ◆ minimum outage duration.
- ◆ demand forgiveness duration.
- ◆ outage voltage.

 **CAUTION**

If Demand Forgiveness is enabled, do not use demand values to calculate energy for billing purposes.

Using the Front Panel

You cannot enable or edit Demand Forgiveness settings via the front panel.

Using ION Setup

ION Setup version 1.1 and later supports the Demand Forgiveness feature:

1. Launch ION Setup and double-click the Setup Assistant.
2. Select the Demand setup screen, and click on the Demand Forgiveness tab.
3. Select *Demand Forgiveness Enable*.
Click Edit, (provide a password if requested), and select ON.
4. Select *Min Outage Duration*, and click Edit.
Type the amount of time (in seconds) that the power must be out before the Demand Forgiveness period starts, and click OK.
5. Select *Demand Forgiveness Duration* and click Edit.
Type the amount of time (in seconds) that demand is forgiven (demand inputs are zero), and click OK.
6. If required, select *Outage Voltage* and click Edit.
Type the minimum voltage (line-to-line average in unscaled meter units) that is considered an outage; this is set to 20 volts by default but you can adjust this.

Chapter
10

Inputs / Outputs

This chapter provides information on the meter’s various inputs and outputs (I/O).

All I/O connections are made to the meter’s Essailec connector, located on the rear of the meter. Refer to your Installation Guide for instructions on wiring inputs and outputs and for the general meter I/O specifications.

In This Chapter

◆ Digital I/O	130
Specifying a Port in an ION Module	130
Using the Digital Outputs	132
Digital Output Modules	132
Using the Digital Inputs	135
Digital Input Modules	135
◆ Configuring Inputs and Outputs	136
Using the Front Panel	136
Using ION Setup	136
Using Designer	136

Digital I/O

ION 8800 meters offer a variety of I/O combinations depending on ordering options. The following options are available:

Ordering Code	Outputs	Digital Inputs	Com
A	<ul style="list-style-type: none"> ◆ 8 digital Form A solid-state outputs ◆ 1 Form C mechanical relay ◆ 4 Form C solid-state outputs 	None	One RS-485 port on Essailec connector
B	<ul style="list-style-type: none"> ◆ 8 digital Form A solid-state outputs ◆ 1 Form C mechanical relay ◆ 4 Form C solid-state outputs 	3 Low voltage	None
C	<ul style="list-style-type: none"> ◆ 8 digital Form A solid-state outputs ◆ 1 Form C mechanical relay ◆ 4 Form C solid-state outputs 	3 High voltage	None
D	<ul style="list-style-type: none"> ◆ 1 Form C mechanical relay ◆ 4 Form C solid-state outputs ◆ IRIG-B (future release) 	3 Low voltage	One RS-485 port on Essailec connector
E	<ul style="list-style-type: none"> ◆ 1 Form C mechanical relay ◆ 4 Form C solid-state outputs ◆ IRIG-B (future release) 	3 High voltage	One RS-485 port on Essailec connector

Two front panel infrared/LED outputs are also standard for all meters.

The digital inputs are ideal for monitoring status or counting pulses from external dry contacts. Use the Form A outputs for performing end of interval pulsing, load control and alarm annunciation, and the Form C solid-state outputs for load switching applications. The infrared/LED outputs are used for energy pulsing (watt-hours and var-hours).

Digital Input modules control the meter's digital inputs. The outputs can be controlled by Digital Output modules, Pulser modules, or Calibration Pulser modules. All of these modules act as intermediaries between the hardware port and the other modules in the meter; they define the characteristics of outgoing signals or tell the meter how to interpret incoming signals.

Refer to the technical note *Digital and Analog I/O* for more information on digital inputs and outputs.

Specifying a Port in an ION Module

Configure the Digital Output, Digital Input, Pulser, and Calibration Pulser modules' *Port* setup registers to specify which port handles the outgoing or incoming signals. To assign a port to one of these modules, simply modify the *Port* setup register by picking a port from the enumerated list. This can be done with both Designer and ION Setup.

Be aware that the enumerated list only displays those ports that are not yet assigned to another module. For example, the meter's factory configuration makes use of Digital Output DO4 (it is already assigned to Calibration Pulser module "varh rec pulse -D4").

If you create a new Digital Output module and go to set its *Port* setup register, the port DO4 will not appear in the list of available ports.

To make a port available, you must first locate the module controlling the port and set its *Port* setup register to NOT USED (or delete the module entirely). The port now appears in the enumerated list.

The following table describes the ports that can be configured (in the Digital Output, Pulser, Digital Input, and Calibration Pulser modules) to handle digital outgoing or incoming signals.

Output Port Names	Description
Port D01	Digital (Form C Solid-State) Output port 1
Port D02	Digital (Form C Solid-State) Output port 2
Port D03	Digital (Form C Solid-State) Output port 3
Port D04	Digital (Form C Solid-State) Output port 4
Port D05	Digital (Form A Solid-State) Output port 5
Port D06	Digital (Form A Solid-State) Output port 6
Port D07	Digital (Form A Solid-State) Output port 7
Port D08	Digital (Form A Solid-State) Output port 8
Port D09	Digital (Form A Solid-State) Output port 9
Port D010	Digital (Form A Solid-State) Output port 10
Port D011	Digital (Form A Solid-State) Output port 11
Port D012	Digital (Form A Solid-State) Output port 12
kvarh Pulse/LED	pulser port/LED Output
kWh Pulse/LED	pulser port/LED Output
Alarm LED	LED Output
Indicator LED	LED Output
Input Port Names	Description
Port DI1	Digital (Status) Input port 1
Port DI2	Digital Input port 2
Port DI3	Digital Input port 3

Using the Digital Outputs

Use the meter's digital outputs for hardware relay control or pulse counting applications. For example, your meter's digital outputs can provide on/off control signals for capacitor banks, generators, and other equipment. The digital output ports can also send out status signals or Wh pulses, if the receiving device determines energy usage by counting pulses.

The meter can include a Form C mechanical relay, Form A solid-state digital outputs and Form C solid-state digital relays. All digital outputs can deliver a continuous signal or a pulse.

Contact Power Measurement for complete information regarding relay applications.

CAUTION

The relay outputs of the meter should never be used for primary protection functions. Be sure that you are familiar with the warnings at the beginning of this document, as well as those presented in your meter's Installation Guide.

These outputs can be controlled by Digital Output modules, Pulser modules, or Calibration Pulser modules, depending on the application. For relay and control, use the Digital Output module. For pulsing applications, the Pulser and Calibration Pulser modules are generally used.

NOTE

Because mechanical relays have limited lifetimes, mechanical KYZ relays are typically not suitable for energy pulsing applications. For energy pulsing applications, consider using solid-state outputs in KYZ mode.

Digital Output Modules

Both the Form A and Form C relays can be controlled with Digital Output modules, Pulser modules, or Calibration Pulser modules. By default, several Digital Output modules are already created for this purpose. You can use these modules, or create and configure other modules to control the output ports.

- ◆ **Calibration Pulser modules** allow you to generate high accuracy energy pulses for calibration testing purposes. They integrate instantaneous power appearing at their inputs.
- ◆ **Digital Output modules** accept Boolean inputs, and output a continuous signal or pulses.
- ◆ **Pulser modules** convert instantaneous pulses to pulses or transitions.

Consult the *ION Reference* for more information about these ION modules.

Configure the settings of the controlling module to match your requirements. The settings in these modules are as follows:

ION Module	Setup Registers	Available Settings	Creation Default	Description
Digital Output	Port	NotUsed Port DO1 Port DO2 Port DO3 Port DO4 Port DO5 Port DO6 Port DO7 Port DO8 Port DO9 Port DO10 Port DO11 Port DO12 kvarh Pulse/LED kWh Pulse/LED Alarm LED Indicator LED	NotUsed	The output hardware channel
	PulseWidth	0 to 2000000	0	Pulse Width, in seconds (0 for continuous pulse)
	Polarity	Inverting or Non-Inverting	Non-Inverting	Inverted or non-inverted output
	EvLog Mode	Log On or Log Off	Log Off	Whether or not to log status changes in the Event Log
Pulser	Port	As per Digital Output, above	NotUsed	The output hardware channel
	PulseWidth	0.020 to 2000000	1	Pulse width, in seconds
	OutputMode	Pulse or KYZ	Pulse	Full pulse or KYZ (transition pulse)
	Polarity	Inverting or Non-Inverting	Non-Inverting	Inverted or non-inverted output
Calibration Pulser	Port	As per Digital Output, above	Depends (see section below)	The output hardware channel
	Pulse Width	0.010 to 1.000	0.05	Pulse Width, in seconds
	Kt	0.01 to 1000000000	1.8*	Watts per pulse
	Int Mode	Forward, Reverse, Absolute, or Net	Depends (see section below)	Integration modes that may be selected
	OutputMode	Pulse or KYZ	Pulse	Full pulse or KYZ (transition pulse)

* Value depends on meter's nominal current option.

Ensure that the module's *Port* setup register matches the meter's output you want to control. If the port you want to use does not appear in the *Port* setup register's list, it means that port is in use by another module. Edit the *Port* setup register of the module using that port and set it to NOT USED – the port will then be available to other modules.

Calibration Pulsing Relays

Six digital outputs are factory configured for calibration pulsing and require no further setup:

Calibration Module	Setup Registers	Creation Default
varh del pulse	Port	DO3 FormC
	Int Mode	Forward
varh Pulse LED	Port	kvarh Pulse/LED
	Int Mode	Absolute
varh rec pulse	Port	DO4 FormC
	Int Mode	Reverse
Wh del pulse	Port	DO1 FormC
	Int Mode	Forward
Wh Pulse LED	Port	kWh Pulse/LED
	Int Mode	Absolute
Wh rec pulse	Port	DO2 FormC
	Int Mode	Reverse

The Calibration Pulser module labeled *varh rec pulse* controls port 4. By default, the module is linked to the *kW del+rec* output of the Arithmetic module labeled “*del, rec*” in the Demand Framework. This Arithmetic module is linked to the MU Power Meter module’s *MU kW tot* output. The port will output a pulse for every 1 Wh accumulated (in NORMAL or TEST mode); this is the same pulsing rate as the middle LED on the front panel of the meter. See the Energy Pulsing chapter for more information.

Alarm LED



Use the red (top) LED on the front panel of the meter for custom alarming applications. It can be linked to a framework to provide event notification. Possible applications include sag/swell alarming, setpoint annunciation, and tariff notification. Like all outputs on the meter, this port can be controlled by a Digital Output, Pulser, or Calibration Pulser module.

Indicator LED

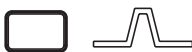

Use the green (middle) LED on the front panel of the meter for custom alarming applications. It can be linked to a framework to provide event notification. Possible applications include sag/swell alarming, setpoint annunciation, and tariff notification. Like all outputs on the meter, this port can be controlled by a Digital Output, Pulser, or Calibration Pulser module.

Using the Digital Inputs

Use the meter's digital inputs for status monitoring or pulse counting applications. Status monitoring can help you prevent equipment damage, improve maintenance, or track security breaches. Some common status monitoring applications are monitoring the closed/open positions of breakers, on/off status of generators, armed/unarmed conditions in a building alarm system, and over/under pressures of transformers.

Digital Input modules control the function of each status input, telling the meter how to interpret incoming signals. Digital Input modules can be linked with other modules for counting status changes.

Digital Input Modules

The meter provides three default Digital Input modules (labeled DI1 to DI3) for the status inputs. Configure the settings of the controlling module to match your requirements.

The settings in the Digital Input modules are as follows:

Setup Register	Available Settings	Creation Default	Description
Input Mode	Pulse, KYZ or A/C	Pulse	Complete pulse, KYZ transition pulse, or A/C input mode
EvLog Mode	Log Off or Log On	Log Off	Whether or not to log status changes in the Event Log
Polarity	Non-Inverting or Inverting	Non-Inverting	Non-inverted (or level) pulse
Debounce	0 to 65.525	0.000	Mechanical contact bounce, in seconds
Port	NotUsed Port DI1 Port DI2 Port DI3	NotUsed	The input hardware channel controlled

Configuring Inputs and Outputs

Use ION software to configure the meter's I/O framework.

Using the Front Panel

You cannot configure I/O using the Front Panel.

Using ION Setup

The Inputs/Outputs Setup Assistant helps you configure the Calibration Pulser modules. See the Energy Pulsing chapter for information on configuring the Calibration Pulser modules in ION Setup.

You can configure *all* I/O related modules using Advanced Mode.

1. Connect to your meter, using Advanced Mode.
2. Click the module you wish to configure.

Using Designer

Open your meter in Designer and navigate to the Advanced Configuration framework. Click on the appropriate grouping object (Digital Inputs or Digital Outputs) and right-click the module you want to edit.

Chapter
11

Energy Pulsing

This chapter provides instructions for configuring energy pulsing on your meter.

In This Chapter

◆ Introduction	138
◆ Configuring Energy Pulsing	138
Using the Front Panel	138
Using ION Setup	138
Using Designer	139
Pulser Module Settings	139
Calibration Pulser Module Settings	140
Energy Pulsing with Infrared Ports and LEDs	141

Introduction

Your meter uses Calibration Pulser modules and Pulser modules for energy pulsing.

The Pulser module serves as an intermediary between other modules' pulse output registers (accepting them as pulse inputs) and a hardware output channel on the device. These modules are capable of sending pulses or pulse transitions to any hardware output channel.

The Calibration Pulser module is a highly accurate energy pulser used for verifying calibration on meters employed in billing applications. This module type serves as an intermediary between the power (kW, kvar or kVA) outputs of the Power Meter module and a device's hardware output channel.

See the *ION Reference* for more information on these modules.

Configuring Energy Pulsing

Use ION software to change your meter's energy pulsing settings.

Using the Front Panel

You cannot configure Energy Pulsing using the front panel.

Using ION Setup

The Energy Pulsing Setup Assistant helps you configure the Calibration Pulser modules.

1. Open ION Setup and connect to your meter, using Basic Mode.
2. In the Setup Assistant, navigate to Inputs/Outputs > Energy Pulsing

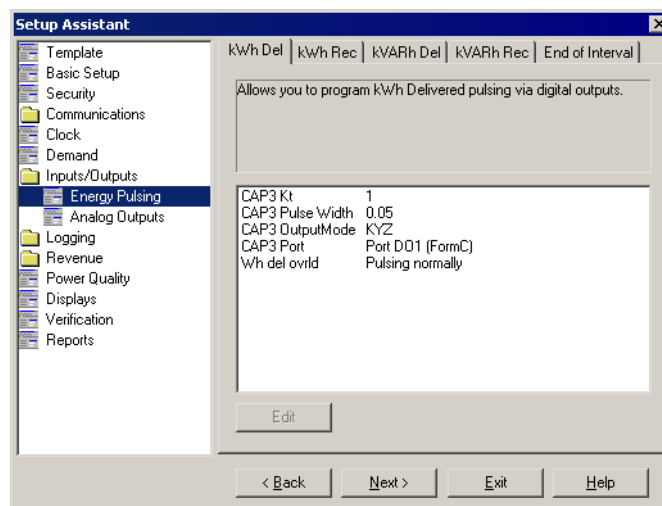

3. Click any of the first four tabs; each tab corresponds to a Calibration Pulser module. Configure each module as necessary.
4. Click the End of Interval tab to configure the end of energy pulsing.

You can configure *both* the Calibration Pulser and Pulser modules using Advanced Mode.

1. Connect to your meter, using Advanced Mode.
2. Click the module you wish to configure.

Using Designer

Open your meter in Designer and navigate to the Energy Pulsing Setup Framework. Right-click a module to edit.

Pulser Module Settings

The Pulser module contains the following setup registers:

Setup Register	Function	Default
PulseWidth	This register specifies the width of the output pulses (in seconds).	0.05
OutputMode	This register defines whether the output is a complete pulse or a transition pulse (KYZ).	Pulse
Polarity	This register specifies the polarity of a pulse output. It has no effect if <i>OutputMode</i> is KYZ.	Non-Inverting
Port	This register specifies which hardware port the output appears on. Only those hardware channels that are still available appear in this list.	NotUsed

NOTE

For safety reasons, no hardware channel is pre-selected. To make use of these links, you must configure the Pulser modules' *Port* setup registers to the appropriate hardware port that receives the output.

Calibration Pulser Module Settings

The meter contains four Calibration Pulser modules pre-configured for energy pulsing:

- ◆ Wh Del
- ◆ Wh Rec
- ◆ varh Del
- ◆ varh Rec

By default, the meter generates a pulse for every 1 Wh accumulated. This is the same pulsing rate as the front panel LEDs (controlled by Calibration Pulser modules labeled “varh Pulse LED” and Wh Pulse LED). Modify the pulsing rate by changing the value of the *Kt* setup register of the Calibration Pulser module controlling them (see below).

Other register defaults vary depending on the Calibration Pulser module.

The following setup registers are available in the Calibration Pulser module:

Setup Register	Function
Pulse Width	This register specifies the width of the pulses sent to the hardware channel (in seconds). The Calibration Pulser module maintains a minimum duty cycle of 50% on the output pulse train.
Kt	The numeric bounded register defines how much energy (watt-hours) the module accumulates before a pulse is sent to the hardware channel.
Int Mode	Specifies the modes of integration that may be selected.
OutputMode	This register specifies whether the output is a complete pulse (Pulse) or a change of state transition (KYZ).
Port	This register specifies which hardware port the pulse/KYZ transition appears on. Only those hardware channels that are still available appear in this list.

Energy Pulsing with Infrared Ports and LEDs

Two LEDs on the front panel are preconfigured for energy pulsing. Matching infrared outputs are located below each LED and pulse at the same rate.

The LED's pulse rate can be adjusted by modifying the *Kt* setup register in the Calibration Pulser module. The value entered defines how much energy the module accumulates before a pulse is sent to the hardware channel. The front panel Wh and varh LEDs are factory set to the same pulse rate (1 Watt-hour).

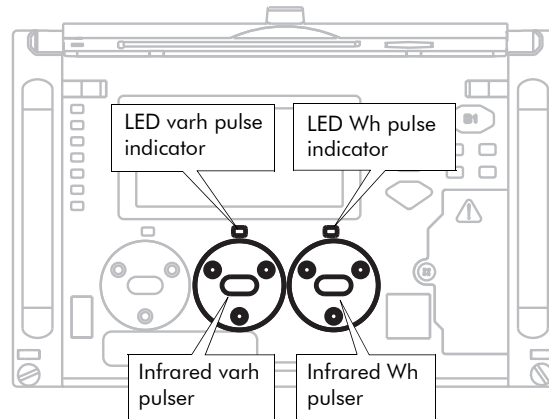

Wh – LED and varh – LED

The Wh – LED is controlled by a Calibration Pulser module that has its *Source* input linked to the *kW del+rec* output of the Arithmetic module labeled “*kW del, rec*”.

Similarly, the varh – LED is controlled by a Calibration Pulser module that has its *Source* input linked to the *kvar del+rec* output of the Arithmetic module labeled “*kvar del, rec*”.

Customizing Energy Pulsing

Changing the value for the *Kt* setup register of the controlling Calibration Pulser module lets you modify the pulsing rate of either channel. If you want to configure the LED port for a different pulsing application, you must re-link the *Source* input to the output register of a different instantaneous power quantity in one of the Arithmetic modules. Ensure that the quantity you choose originates from the MU (meter units) Power Meter module.

Chapter
12

Logging

Your meter includes data logging and event recording capabilities. Data and event logs recorded by the meter are prioritized and stored onboard. This data is then retrieved periodically by the ION Enterprise Log Server or another third party application.

If you use ION Enterprise software, all retrieved data from your system is stored in an ODBC-compliant database. The information in the database can be viewed and analyzed using ION Enterprise software applications such as Vista (for viewing), or Reporter (for organizing and presenting data).

For more information on Vista and Reporter see the online *ION Enterprise Help*.

In This Chapter

◆ Data Logging	144
Configuring Data Logging	144
Default Logging Configuration -- ION 8800A Meter	148
Viewing Data Logs	150
◆ Event Logging	152
Displaying Events	153
◆ Logging and Recording Capacity	154

Data Logging

Your meter ships with a comprehensive data-logging configuration that differs depending on your meter type. The data recording frameworks contain Data Recorder modules, Waveform Recorder modules (ION 8800A meters only) and Periodic Timer modules.

Data Recorder and Waveform Recorder modules are responsible for logging the power system data, while Periodic Timer modules control the recording frequency of the recorder modules to which they are linked.

To learn more about these modules, consult the *ION Reference*.

CAUTION

Changing logging settings will reset logged values. Ensure that all important data has been recorded before you make changes.

Refer to the section “Default Logging Configuration -- ION 8800A Meter” for detailed information about your meter’s pre-configured Data Recorder modules.

Configuring Data Logging

Use ION software to change your meter’s logging settings.

Using the Front Panel

You cannot configure Logging using the front panel.

Using ION Setup

The Logging Setup Assistant helps you configure meter data logging.

1. Open ION Setup and connect to your meter, using Basic Mode.
2. In the Setup Assistant, navigate to the Logging folder.

Use the three screens (Memory, Revenue Log and EnergyDemand Log) to configure various logging settings.

Memory Screen

3. Select the Memory screen to re-allocate meter memory.

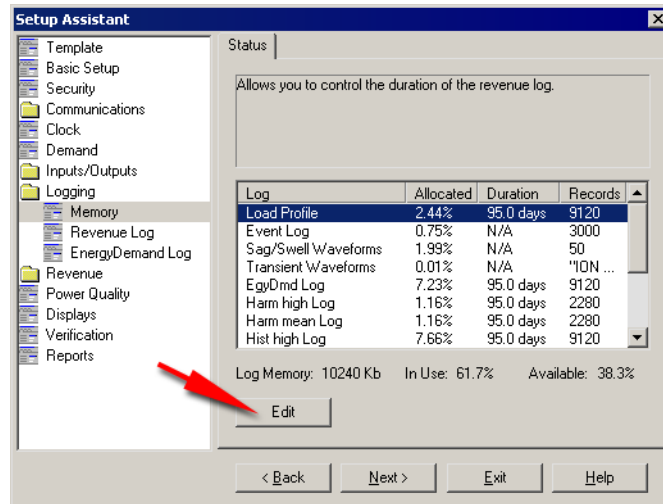

4. Select the Log you wish to configure and click Edit. You can change both the Log Duration (days) and the Log Size (records). Notice how changing these parameters affects the meter memory allocated to that log.

Revenue Log Screen

5. Select the Revenue Log screen to configure Data Recorder #1 (the Revenue Log).

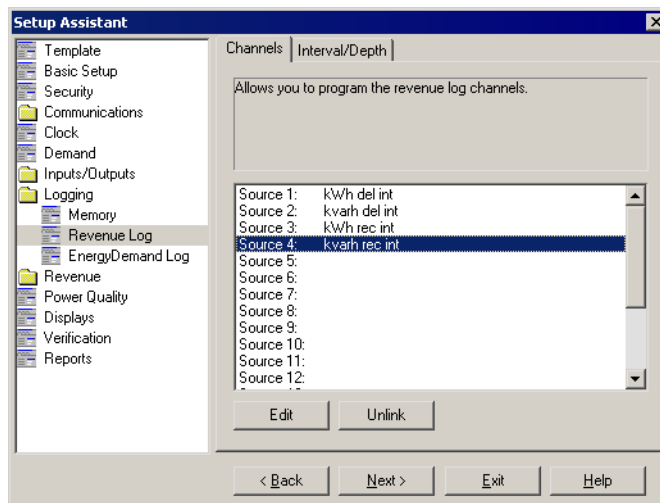

6. Click the Channels tab to edit, link and unlink revenue parameters.
7. Click the Interval/Depth tab to edit the interval and duration of the revenue log.

EnergyDemand Log Screen

- Select the EnergyDemand Log screen to configure Data Recorder #10 (Energy Demand Log).

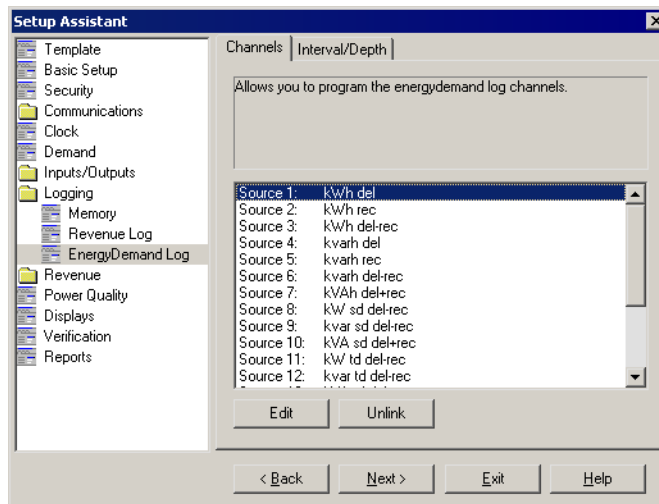

- Click the Channels tab to edit, link and unlink energy/demand log parameters.
- Click the Interval/Depth tab to edit the interval and duration of the energy/demand log

Changing the parameters that are logged

The meter's factory configuration logs a comprehensive set of energy, power and harmonics parameters. You cannot change which parameters are logged by configuring a setup register. If you are comfortable editing module links, you can change the logged parameters by linking the output registers you want logged to the inputs of an Data Recorder module.

NOTE

Adding or deleting a log's parameters is an advanced procedure, as it requires changes to the links between modules; use Designer (refer to the Designer section of the online *ION Enterprise Help*) or ION Setup.

Changing waveform recording (if supported)

The Waveform Recorder modules do not require changes to their default settings. If you want to change the format of the recorded waveforms, refer to the Waveform Recorder module description in the *ION Reference*.

Default logging capacity -- ION 8800A meter

The following table summarizes the default recording depths and recording intervals of the various Data recorders and Waveform recorders in the ION 8800A meter.

 **NOTE**

Default logging depth is set differently for 5 MEG on-board memory (“one-month”) and 10 MEG (“three-month”) option meters. See below.

Data Recorder Number	Log Name	Depth		Interval
		5 MEG	10 MEG	
1	Revenue Log	3360 (35 days)	9120 (95 days)	900 seconds (15 minutes)
9	Loss Log	3360 (35 days)	3360 (35 days)	900 seconds (15 minutes)
3, 4, 5	Historic Logs (3 data recorders)	3360 (35 days)	3360 (35 days)	900 seconds (15 minutes)
7, 8	Harmonics Logs (2 data recorders)	840 (35 days)	840 (35 days)	3600 seconds (1 hour)
N/A	Waveform recording (6 data recorders)	30	50	Triggered on demand
10	Report Generator Log (EgyDmd Log)	3360 (35 days)	9120 (95 days)	900 seconds (15 minutes)
2	Dip/Swell Log	100	3000	Triggered on demand
6	Transient Log	100	3000	Triggered on demand
N/A	Event Log (Event Log Controller module)	100	500	Triggered on demand
11 - 32	EN50160 Logs (22 data recorders) (EN50160 ordering option only)	Varies ¹	Varies ¹	Daily, weekly, 10 minutes, ...

¹ See the *Power Quality: ION Meters and EN50160* technical note for more details.

Changing the log depths

Change the value in the Data Recorder’s *Depth* setup register to increase the number of records stored in the recorder. The *RecordMode* setup register controls how the Data Recorder will overwrite old records; refer to the Data Recorder module description in the *ION Reference* before changing this setup register.

Changing the frequency of logging

The five Periodic Timer modules that control the frequency of different data recording are as follows:

- ◆ “Revenue Log Trg” controls the frequency of the logging of revenue values
- ◆ “Loss Log Trg” controls the frequency of Loss Compensation Data logging
- ◆ “EgyDmd Log Trg” controls the frequency of logging for the Energy and Demand Log (this log is used for generating reports using Reporter)
- ◆ “Hist Log Trg” controls the frequency of Historic Data logging
- ◆ “Harm Log Trg” controls the frequency of Harmonics logging

CAUTION

Programming your meter to write any data recorder at continuous intervals lower than 20 seconds (heavy logging configuration) may cause loss of data in the event of a power failure. Use of an uninterruptible power supply (UPS) is recommended for such heavy logging configurations if data needs to be available after a power cycle.

Change the value in the *Period* setup register to change the frequency of data logging (Period values are specified in seconds).

Default Logging Configuration -- ION 8800A Meter

The following sections describe each Data Recorder and the parameters it logs.

Revenue Log

The *Revenue Log* is configured for use with UTS MV-90 billing software. The default values logged by the Revenue Log are as follows:

Parameter	Description
kWh del int	Interval kWh delivered
kWh rec int	Interval kWh received
kvarh del int	Interval kvarh delivered
kvarh rec int	Interval kvarh received

Historic Data Logging

Three data recorders are used to record standard power system quantities, such as phase current, phase voltage and power factor. These recorders are labeled *Hist Mean Log*, *Hist High Log*, and *Hist Low Log*. By default, they log the following ION output register values:

Hist Mean Log	
Ull 12 mean	I avg mean
Ull 23 mean	I 4 mean
Ull 31 mean	kW tot mean
Ull avg mean	kvar tot mean
U unbal mean	kVA tot mean
I1 mean	PF lag mean
I2 mean	PF lead mean
I3 mean	Freq mean

Hist High Log	
Ull 12 high	I avg high
Ull 23 high	I 4 high
Ull 31 high	kW tot high
Ull avg high	kvar tot high
U unbal high	kVA tot high
I1 high	PF lag high
I2 high	PF lead high
I3 high	Freq high

Hist Low Log	
Ull 12 low	I avg low
Ull 23 low	I 4 low
Ull 31 low	kW tot low
Ull avg low	kvar tot low
U unbal low	kVA tot low
I1 low	PF lag low
I2 low	PF lead low
I3 low	Freq low

Loss Log

The *Loss Log* recorder is configured to record loss values. By default, it logs the following ION parameters:

Parameter	Description
MU I1 ^ 2h int	Phase 1 interval current squared hours
MU I2 ^ 2h int	Phase 2 interval current squared hours
MU I3 ^ 2h int	Phase 3 interval current squared hours
MU Ull 12 ^ 2h int	Phase 1 interval voltage Line-to-Line squared hours
MU Ull 23 ^ 2h int	Phase 2 interval voltage Line-to-Line squared hours
MU Ull 31 ^ 2h int	Phase 3 interval voltage Line-to-Line squared hours

Harmonics Logging

Two recorders provide various harmonics logs, including K-factor and Total Harmonics Distortion (THD). These recorders are labeled *Harm Mean Log* and *Harm High Log*. By default, they log the following ION output register values:

Harm Mean Log		Harm High Log	
U1 THD mean	I1 K Fac mean	U1 THD high	I1 K Fac high
U2 THD mean	I2 K Fac mean	U2 THD high	I2 K Fac high
U3 THD mean	I3 K Fac mean	U3 THD high	I3 K Fac high
I1 THD mean		I1 THD high	
I2 THD mean		I2 THD high	
I3 THD mean		I3 THD high	

ION Enterprise Reporting

One recorder is configured to provide power system data for the Reporter software. This recorder is labeled *Egy Dmd Log*. If any input links to this module are changed, Reporter will not be able to create reports from the device's logs. If you use Reporter, do not change the parameters that are logged in the *Egy Dmd Log*.

Dip/Swell and Transient Logging

The meter logs the following ION output register values:

Dip/Swell Log			
DistDur	DistU2Engy	DistU1Engy	DistU3Engy
DistU1Min	DistU3Min	DistU2Min	DistNominal
DistU1Max	DistU3Max	DistU2Max	SwellLim
DistU1Avg	DistU3Avg	DistU2Avg	SagLim

Transient Log			
TranU1Dur	TranNominal	TranU2Max	PT Sec
TranU1Max	Threshold	TranU3Dur	CT Prim
TranU2Dur	PT Prim	TranU3Max	CT Sec

EN50160 Compliance Logging (EN50160 ordering option only)

By default, 22 Data Recorders are used for logging EN50160 compliance parameters.

Data Recorder	EN50160 Component Logged	Data Recorder	EN50160 Component Logged
EN50160 Frq/Mg	Power Frequency and Supply Magnitude	EN50160 Uunbal	Voltage Unbalance
EN50160 Flicker	Flicker	EN50160 Hrm Vlt	Harmonics (up to 40th)
EN50160 Vlt Dp1	Supply Voltage Dips	EN50160 lhm Vlt	
EN50160 Vlt Dp2		EN50160 MSignal	Mains Signalling Voltage
EN50160 Vlt Dp3		EN50160 Prm-f/V	Parameter data These data recorders are disabled by default (see below).
EN50160 Vlt Dp4		EN50160 Prm-Flk	
EN50160 Vlt Dp5		EN50160 Prm-VDp	
EN50160 Intrp	Short/Long Interruptions		
EN50160 OvrVlt1	Temporary Overvoltages	EN50160 Prm-Vlr	
EN50160 OvrVlt2		EN50160 Prm-OV	
EN50160 OvrVlt3		EN50160 PrmHrm1	
		EN50160 PrmHrm2	

The meter logs EN50160 counter data for present and previous observation periods. EN50160 events are also logged. EN50160 parameter data logging (from seven "Prm" data recorders) is disabled by default. The EN50160 Parameter Logging enable is accessible in the default Power Quality Vista diagram.

For more information about EN50160 data logging, refer to the technical note *Power Quality: ION Meters and EN50160*.

Viewing Data Logs

See the Report chapter. You can also view Data Logs using ION Setup.

1. Open your meter in ION Setup, using Basic Mode.
2. Navigate to View > Data Screens > Data Recorders. The following logs are available for viewing:
 - ◆ Average Harmonics
 - ◆ Energy & Demand
 - ◆ Historic Average, Historic Highs, Historic Lows

- ◆ Maximum Harmonics
- ◆ Revenue Log
- ◆ Sags & Swells
- ◆ Transformer Losses
- ◆ Transients (if supported)

Event Logging

Events produced by a meter's various ION modules are prioritized and grouped to facilitate custom logging. Each event is assigned a priority group number based on its type and severity.

ION Event Priority Groups

Some event groups are preset with a Priority Number as shown in the table below. You can also define your own priority number for some modules. Priority numbers from 128-191 appear in the global event log viewer in ION Enterprise software. Priority numbers from 192-255 are logged, initiate a beep and cause the window to flash. You can customize these responses to display messages or perform *net send* messages, for example.

Event Group	Description	Priority Number
Reset	Module reset or re-synchronized	5
Setup Change	Module setup changes (setup register changes, label changes, input handle changes)	10
Input Register Change	Inputs of certain modules change value (ie, input to And/Or module changes)	15
I/O State Change	I/O state changes (ie, relay closes)	20
Information	Module produces important user information	25
Warning	Module produces a warning	30
EN50160 Event (EN50160 ordering option only)	An EN50160 Counter (N ₁ or N ₂) increases	50
Failure	A failure has occurred	255
Setpoint	Setpoint condition goes Active or Inactive (ie, Sag/Swell module detects a disturbance)	programmable via module setup

The Event Log Controller module allows you to set a priority cutoff for event logging. Any events with a priority number greater than the cutoff value are logged, and events with lower priorities are discarded. Refer to the individual module descriptions and the Event Log Controller module description in the *ION Reference* for more details.

External ION Events

Some events are not produced by a specific module. These events are generated internally by the meter. Their associated priority levels are shown in the table below.

Event Group	Description	Priority Number
Warning	Factory initialize performed	30
	Firmware or memory upgrade performed	
	Meter power-up or power-down	
	Internal modem not responding or modem recovered	
	Battery low	
	Telnet or serial terminal locked out	
	Security disabled or enabled	
Failure	Communications fail to allocate required memory	255

Displaying Events

View Events in the following locations:

Application	Menu / Screen	Navigation
Front Panel	Event Log	ALT Display Mode > Events Screen
ION Setup	Event	Display Mode > Data Recorders folder > Event
Vista	Meter Events	System & Logs tab > Meter Events object
WebMeter	N/A	N/A

Logging and Recording Capacity

The meter provides both data and event logs. The amount of memory required to store these logs depends on the number of parameters being logged and the frequency with which these parameters are logged.

The following equation can help determine the amount of memory required to store **data and event logs**:

$$\text{each record consumes (in Bytes)} = [(\text{number of parameters} * 5) + 8]$$

The meter can also perform waveform recording. It can simultaneously capture events on all channels to a maximum of 96 cycles each.

To calculate the **waveform memory** usage use the following formula:

$$\text{waveform memory usage (in Bytes)} = [2 * (\text{number of samples per cycle} + 10) * (\text{number of cycles in waveform}) + 30]$$

NOTE

Round up to the next kilobyte after each of the above calculations.

Chapter 13

Revenue

This chapter provides instructions for configuring PT/CT correction, transformer line loss compensation (TLC) and time of use (TOU).

In This Chapter

◆ PT/CT Correction	156
Configuring PT/CT Correction	156
◆ Transformer Line Loss Compensation (TLC)	158
Configuring TLC	158
◆ Time of Use	161
Configuring Time of Use	161
Time Of Use Module Settings	162
Creating a New Time Of Use Schedule	163
Displaying Time of Use	163

PT/CT Correction

The primary application for PT/CT correction is to apply correction factors for ratio errors and phase angle errors to instrument transformers. Instrument transformer correction reduces or eliminates the need to replace transformers in installations where high-accuracy is required.

Configuring PT/CT Correction

PT/CT Correction (the *Instr Xformer* module in the meter's firmware) can be configured in the ION 8800 via ION software.

Using the Front Panel

You cannot configure PT/CT Correction using the front panel.

Using ION Setup

In the following ION Setup example, the PT/CT Correction Setup Assistant allows you to configure the *Instr Xformer* modules on the ION meters.

1. Open ION Setup and connect, in Basic Mode, to the desired meter.
2. Open the Revenue folder in the Setup Assistant and click PT/CT Correction.
3. Select the Active Correction and click Edit.

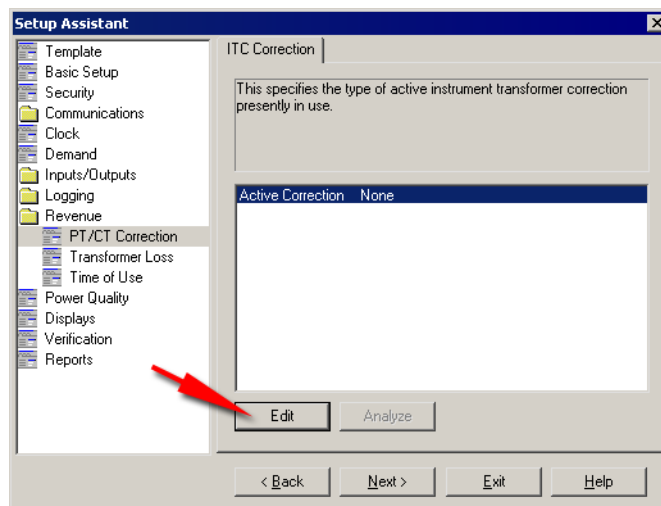

The Transformer Correction wizard guides you through configuration.

4. Select the Voltage Inputs check box to turn on voltage (PT) correction, and the Current Inputs check box to turn on current (CT) correction.

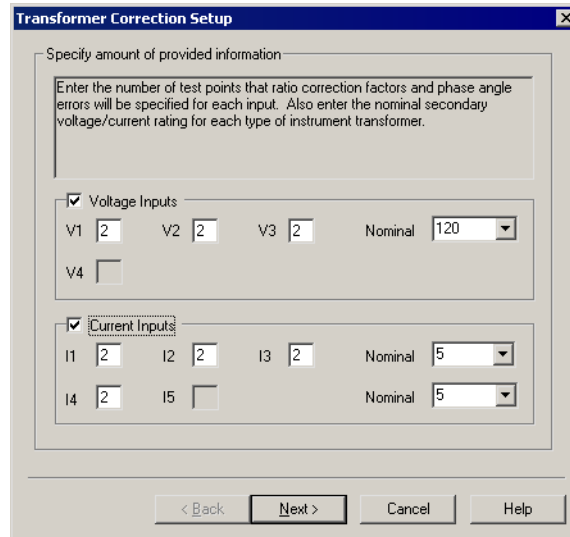

5. Enter the number of test points for each (four maximum), and the nominal voltage/current. Click Next to proceed.

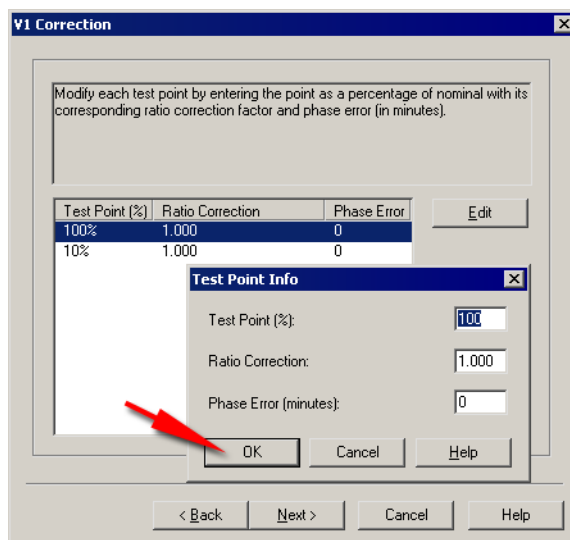

6. On the U1 Correction screen, select a U1 Test Point and click Edit. Enter the Test Point Info into the dialog box and click OK. Click Next.
7. Repeat previous step for each voltage and current phase. Click Next to finish.

The Instrument Transformer Correction module is a core module; there is an ITC module for each current input (I1, I2, I3, I4, I5) and for each voltage input to the meter (U1, U2, U3, U4). Note that the correction affects only the 1-second values in the Power Meter module. No high-speed, harmonics, or waveform values are affected by the correction. For more information, see the ITC (*Instr Xformer*) module description in the online *ION Reference*.

Transformer Line Loss Compensation (TLC)

Transformer Loss Compensation is used when a meter's actual location is different from the electrical location where change of ownership occurs; for example, where meters are connected on the low-voltage side of power transformers when the ownership change occurs on the high-side of the transformer. This physical separation between meter and actual billing point results in measurable losses. Compensating for this loss - Loss Compensation - is the means of correcting this meter reading. Losses may be added to or subtracted from the meter registration.

Meters are usually installed on the low-voltage side of a transformer because it is more cost-effective. There are also cases where change of ownership may occur halfway along a transmission line where it is impractical to install a meter. In this case, power metering must again be compensated.

CAUTION

Due to the variation in installations, **advanced knowledge of power systems and connection methods is required before transformer loss compensation can be properly implemented.** Data parameters should only be programmed by qualified personnel that have appropriate training and experience with Transformer Loss Compensation calculations.

For more information, see the latest version of the *Transformer Line Loss Compensation* technical note.

Configuring TLC

Use ION software to change your meter's TLC settings.

Using the Front Panel

You cannot configure Transformer Line Loss Compensation using the front panel.

Using ION Setup

The Revenue Setup Assistant helps you configure TLC. The Transformer Loss screen allows you to enable/disable TLC, choose which method you prefer (1 or 2) and configure TLC settings.

1. Open ION Setup and connect to your meter, using Basic Mode.
2. In the Setup Assistant, navigate to Revenue > Transformer Loss

3. First, enable TLC by selecting Loss Comp Enble and clicking the Edit button.

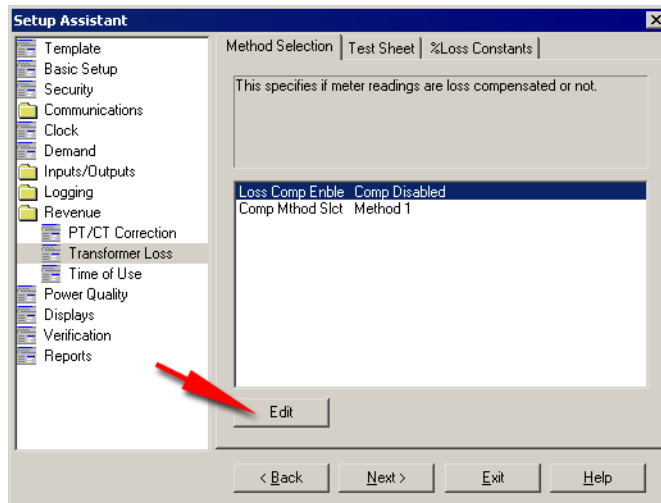

4. Select Comp Enabled from the drop-down list and click OK.
5. Next choose the TLC method you wish to use by selecting Comp Mthod Slct and clicking the Edit button.
Select Method 1 to use the Test Sheet method and Method 2 to use the %Loss Constants method.
6. Finally, click the tab of the TLC method you chose in the previous step and configure the settings for that method.

Using Vista

1. Launch Vista.
2. In the User Diagram screen that appears, click the System & Logs tab.

3. Click the Loss Compensation button. The following window appears:

Click here to enable Loss Compensation calculations

Choose either the Test Sheet or %Loss Constants compensation method

Loss Compensation
(click radio buttons to change state)

Loss Compensation Mode

Loss Compensation Disabled

Loss Compensation Enabled

Loss Compensation Method

Method 1 ("Test Sheet" method)

Method 2 ("%Loss Constants" method)

Note:
If Loss Compensation is enabled, all billing parameters are compensated.

(click boxes, enter value and then press the Enter key)

Loss Calculation - Method 1 ("Test Sheet Method")

Indicate if meter location is supply side or load side

Indicate if meter location is transformer side or not

Not Transformer Side Transformer Side

Instrument Transformer information

PT ratio: Primary V/I rated:

CT ratio:

Transformer Losses

kVA rated: Power Transformer Ratio:

LWFe (no-load): % Excitation:

LWCu (full-load): % Impedance:

Supply Side Line Loss

Line Length:

Resistance/Unit Length:

Reactance/Unit Length:

Load Side Line Loss

Line Length:

Resistance/Unit Length:

Reactance/Unit Length:

Loss Calculation - Method 2 ("%Loss Constants Method")

Instrument Transformer ratios (prim/sec)

PT ratio:

CT ratio:

Meter Information

Rated Meter Voltage:

1/2 Class Meter:

Stator Elements:

Copper Loss Compensation

Enabled

Disabled

%LWCu:

%LVCu:

Iron Loss Compensation

Enabled

Disabled

%LWFe:

%LVFe:

These are the true instrument transformer ratios. Normally they coincide with the Power Meter module's setup.

4. Configure your values as required.

See the *Transformer Loss Compensation* technical note for more details on this feature.

Time of Use

The Time of Use module may only be important if you are using the meter in a billing application (i.e. you are a power provider), as the module contains the meter's seasonal rate schedules. Typically, power consumers do not require Time Of Use configuration.

See the *ION Reference* for more information on the Time of Use module.

Configuring Time of Use

Use ION software to change your meter's Time of Use settings.

Using the Front Panel

You cannot configure Time of Use using the front panel.

Using ION Setup

The Time of Use Setup Assistant helps you configure the Time of Use module.

1. Open ION Setup and connect to your meter, using Basic Mode.
2. In the Setup Assistant, navigate to Revenue > Time of Use

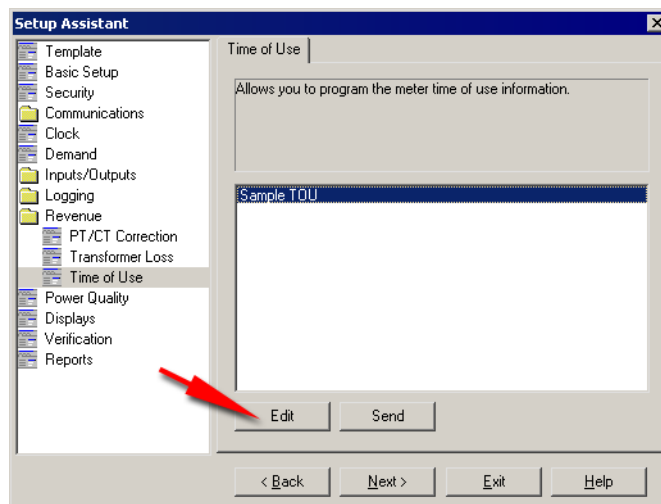

3. Select a Time of Use program from the list (in this example, Sample TOU) and click Edit.
4. Follow the Time of Use Wizard to configure your program. Click Send to save the TOU program on your meter.

Using Designer

Open your meter in Designer and navigate to the Time-of-Use Setup Framework. Right-click the Time of Use module to edit.

Time Of Use Module Settings

The Time of Use module's setup registers define your seasons' start and end dates, the day types where your rates may differ, and the rate schedules for each season's day types. The module compares the meter's internal clock with the season, day, and time of day settings in these registers, and changes its output registers to reflect the current state of these settings.

Seasonal Settings

The Time of Use module supports up to four separate seasons. Each seasons' start and end dates are set into the appropriate *Season* setup register.

NOTE

Ensure that there is no date overlapping when defining seasons and that every day of the year is covered by your seasons. If there are gaps between seasons, the module returns an error and will not function.

If your rates do not change between seasons, you do not need to configure the *Season* setup registers — Season 1 is the default, and all Season 1 rates are in effect all year.

If you have different seasons, enter their start and end dates into the appropriate setup registers. If your season is active on the same dates every year, you only need to enter a single range of dates in the appropriate *Season* setup register. If the active dates are different each year (for example, Season 3 becomes active every first Monday in August), the start dates must be individually specified for each year.

The Time of Use module is partially configured at the factory. Check the setup registers to ensure that the settings match your Time of Use schedules.

Setup Register	Function
Season 1 - 4	These setup registers define the dates for each active season. When a season is active, the Time of Use module will use the applicable rate schedules.
Season 1 - 4 Weekday Rates	These setup registers specify seasonal weekday rates.
Season 1 - 4 Weekend Rates	These setup registers specify seasonal weekend rates.
Season 1 - 4 Alt 1 Rates	These setup registers specify a season's daily rates during the days specified in the Alt 1 Days setup register.
Season 1 - 4 Alt 2 Rates	These setup registers specify a season's daily rates during the days specified in the Alt 2 Days setup register.
Season 1 - 4 Holiday Rates	These setup registers specify a season's daily rates during the days specified in the Holidays setup register.
Weekdays	This register defines the days of the week for all seasons. The rates in the Season (1, 2, 3, or 4) Weekday Rates setup registers are used on these days.
Weekends	This register defines the weekend days for all seasons. The rates in the Season (1, 2, 3, or 4) Weekend Rates setup registers are used on these days.

Setup Register	Function
Alt 1 Days	This register defines a set of alternative dates for all seasons. These dates generally have different rates from weekdays, weekends, or holidays.
Alt 2 Days	This register is similar in function to Alt 1 Days, but contains a different set of dates.
Holidays	This register defines the holidays for all seasons. The rates defined in the Season (1, 2, 3, or 4) Holiday Rates setup registers are used on these days.
Self Read Days	This setup register defines the dates and times that the Self Read output register will pulse. If no time is entered in this register, the Self Read output register will pulse on the date specified at 12:00 AM.

Creating a New Time Of Use Schedule

You can create a new TOU schedule using the TOU Program Manager; the program is a self-documented, graphical wizard. You launch the TOU Program Manager in Designer from the Options menu.

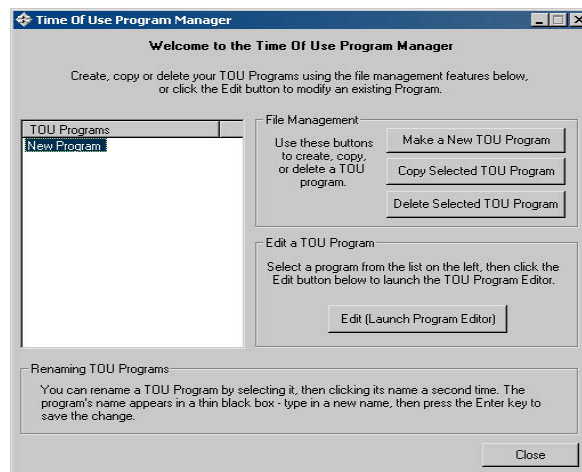

Displaying Time of Use

View Time of Use values in the following locations:

Application	Menu	Navigation
Front Panel	Active TOU Rate, Active TOU Season and TOU Energy by Rate screens	ALT displays
ION Setup	N/A	N/A
Vista	Time of Use Screen	Revenue tab > Time of use object
WebMeter	N/A	N/A

Chapter 14

Power Quality

This chapter explains how to configure your meter's power quality functionality.

In This Chapter

◆ Introduction	166
◆ Configuring Power Quality	166
Using the Front Panel	166
Using ION Setup	166
Using Designer	167
Sag/Swell Module Settings	167
Transient Module Settings	168

Introduction

Power quality capabilities depend on meter type:

- ◆ ION 8800A meters provide full power quality measurement and analysis, including waveforms and transient capture.
- ◆ ION 8800B meters support only EN50160 power quality parameters.
- ◆ ION 8800C meters do not offer power quality functionality.

Power quality configuration is provided by a number of modules, including the Sag/Swell module, the Transient module, and the Mains Signalling Evaluation modules. Your meter may not have all these modules.

See the *ION Reference* for more information on these modules.

Configuring Power Quality

Use ION software to change your meter's power quality settings.

Using the Front Panel

You cannot configure Power Quality from the front panel.

Using ION Setup

The Power Quality Setup Assistant helps you configure the various power quality modules.

1. Open ION Setup and connect to your meter, using Basic Mode.
2. In the Setup Assistant, navigate to the Power Quality folder.

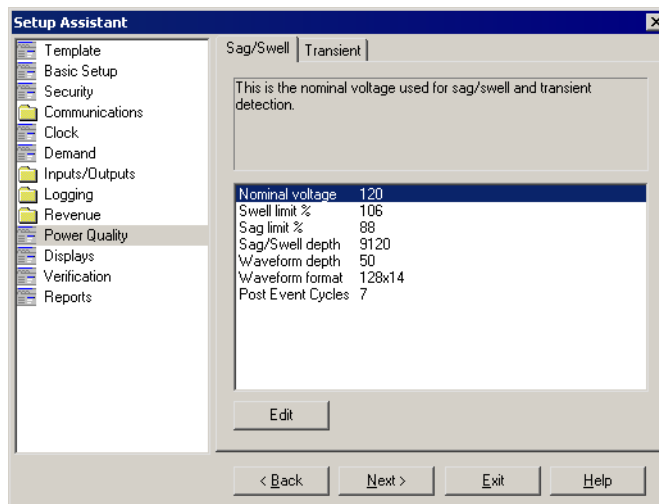

3. Click on the Sag/Swell tab to set sag and swell limits, configure sag/swell waveform recorder settings and most importantly, record your system's nominal voltage.
4. Click on the Transient tab to configure various settings such as voltage deviation threshold and transient waveform recorder depth and frequency.

NOTE

The meter features dual waveform capture: Sags are recorded at 32 samples x 54 cycles. Transients waveform capture at 256 samples x 7 cycles.

Using Designer

Open your meter in Designer and navigate to the Power Quality Setup Framework. Right-click a module to edit.

Sag/Swell Module Settings

The Sag/Swell module monitors voltage waveforms for sags and swells (i.e. ITI [CBEMA] Type 2 and Type 3 disturbances). It then reports each disturbance's magnitude and duration. The Sag/Swell module can also detect sub-disturbances during a Sag/Swell event. Settings are as follows:

Setup Register	Function	Default
Swell Lim	This is the magnitude above which a voltage deviation is considered a swell (percentage of the nominal voltage).	106
Sag Lim	This is the magnitude below which a voltage deviation is considered a sag (percentage of the nominal voltage).	88
Change Crit	This is the amount a voltage signal must change during a disturbance to be considered a new sub-disturbance (percentage of the nominal voltage).	10
Nom Volts	This is the nominal power system voltage (used for all Power Quality functions).	0 ¹
EvPriority	The priority assigned to Sag/Swell and Transient module events (0 to 255, 255 is highest).	200

¹ The primary power system voltage is sometimes different than the PT Primary setup register value (i.e. when the PT Primary is used to indicate winding ratio rather than primary voltage).

Besides *NomVolts*, the only setup registers that you may need to change in the Sag/Swell module are *Swell Lim* and *Sag Lim*. Most applications are served by the default values entered into these registers. The *Change Crit* and *EvPriority* setup registers do not need to be changed for normal operation.

NOTE

If the Sag/Swell module's *Nom Volts* setup register is set to zero, all Sag/Swell module functions are disabled. *Nom Volts* is typically set when the meter is put into service. If *Nom Volts* has not been set, enter a value for your system's nominal voltage (i.e. 120, 277, or 347). The value you enter will also be used by the Transient module.

Transient Module Settings

The Transient module monitors voltage waveforms for transient activity (i.e. ITI [CBEMA] Type 1 disturbances). The *Threshold* setup register defines what voltage disturbance magnitude should be considered as transient activity. *Threshold* is interpreted as a percentage of the nominal system voltage, plus 100. For example, if you want transients recorded when voltage deviates from nominal by 20%, enter 120 into the *Threshold* setup register.

Setup Register	Function	Default
Threshold	This is the magnitude at which a voltage deviation is considered a transient.	125
EvPriority	The priority assigned to Sag/Swell and Transient module events (0 to 255, 255 is highest).	200

Chapter 15

Displays

This chapter explains the available front panel displays. It also includes procedures for customizing displays using ION software.

In This Chapter

◆ Introduction	170
◆ Configuring Front Panel Displays	171
Using the Front Panel	171
Using ION Setup	171
Using Designer	172
◆ Default Front Panel Display Screens	175
NORM mode display screens	175
ALT mode default display screens	176
TEST mode default display screens	179

Introduction

The ION 8800 ships with preconfigured display screens designed to suit the data needs of most users. Different types of screens are available depending upon the meter's current mode of operation (see "Modes of Operation" on page 29 for details).

Front panel displays may also be customized on your meter to show virtually any measurement or calculation. For example, you could do one or all of the following:

- ◆ change displayed parameters, such as from *Ull* to *Uln* or *Ull12* to *Uln1*
- ◆ adjust character size to be different on each screen
- ◆ change data display settings such as backlight timeout, automatic display scrolling, parameter update rate and display mode

Use ION software to customize your front panel display screens.

Configuring Front Panel Displays

Using the Front Panel

Display settings are located in the Display Setup menu. See “Display Setup Menu” on page 35 for details.

Using ION Setup

1. Open ION Setup and connect, in basic mode, to the appropriate meter.
2. In the Setup Assistant, navigate to Displays and click Edit.

ION Setup will upload your meter’s display information to the Display Editor. This may take a few moments.

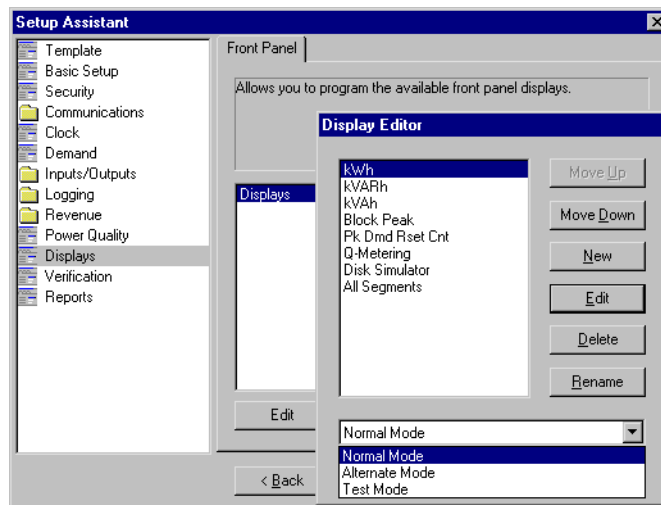

3. Edit, rename, delete or rearrange displays as desired.
4. If you choose to edit or create new display, the Display Editor wizard contains three steps for creating or editing display screens.

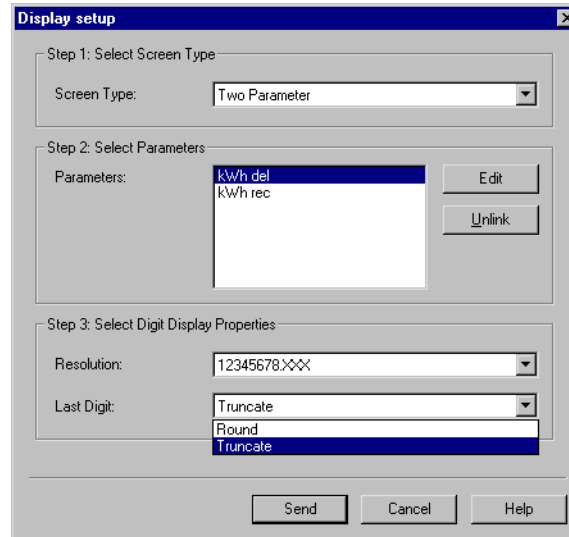

- ◆ Choose the screen type
 - ◆ Select the parameters available for your chosen screen type
 - ◆ Select your display qualities, including digit resolution and truncated or rounded last digits.
5. Click Send to save the changes in the meter.

Using Designer

CAUTION

Before you reconfigure or delete a framework, you should make a copy. This ensures that you can restore the framework without having to reinitialize the factory configuration.

To remove a data display screen:

1. Launch Designer and navigate to the Display Setup framework.
2. Select the Display module responsible for the screen.
3. Press delete. This also deletes all links to that particular Display module.

If the display screen you are deleting is part of the automatic scrolling cycle, you should reconfigure the links from the Scroll module's *Trigger* outputs to the remaining Display modules so that the following considerations hold true:

- ◆ The first Display module in the scrolling cycle is linked to the *Trigger 1* output of the Scroll module.
- ◆ The last Display module in the scrolling cycle (module *n*) is linked to the *Trigger n* output of the Scroll module. For example, if your scrolling cycle consists of 5 screens, then *Trigger 5* should be linked to the fifth module in the cycle.
- ◆ The *Wraparound* setup register of the Scroll module designates the last trigger output (*Trigger n*). Expanding on the previous example, since *Trigger 5* is the last trigger, the Scroll module's *Wraparound* setup register would have a value of 5.

To add a new display screen

1. Create a Display module.
2. Define the modules characteristics (display format) by adjusting its setup registers.
3. Link any required data to the *Source* inputs of the Display module.

If you want your new screen to appear in the automatic scrolling cycle, then you must link the *Show* input of the Display module to a *Trigger* output of a Scroll module.

To create a Disk Simulator screen

1. Create a new Display module, and choose the type as *Disk Simulator*.
2. Connect the new Display module's first input to the Calibration Pulser module's *Disk Position* output that you want to monitor for its pulsing interval.
3. To include the newly added screen to the ALT screen list, connect the Display module's *Show1* and *Show2* inputs to the Scroll module's last available *Trigger* outputs in ALT SCROLL UP and ALT SCROLL DOWN (respectively).

You can determine the last available *Trigger* by right-clicking on the output to discover the *Triggers'* owners.

4. Increase the Scroll module's *Wraparound* setup register by 1 to include the new screen.
5. Configure the remaining display settings according to your needs.

Although the Disk Simulator display is intended to show the disk behavior of mechanical watt-hour meters, this feature can be used to monitor any accumulated meter quantity over the time. To do this, connect the Display module's first input to the meter quantity, and connect the second input to the maximum value that you expect the displayed quantity to be bounded by (this could be any ION output register or an *External Numeric* module register). In this case, (i.e. the Display module is *not* connected to a Calibration Pulser module) the Disk Simulator revolves from left to right.

NOTE

The inputs to the Disk Simulator display are always positive. If the value exceeds the maximum scale value assigned in the second input, then nothing is displayed except labels and the disk rectangle.

To configure leading zeros

The leading zeros and decimal point in a numeric display can be configured with the Display module setup register *Screen Resolution*. For example, the number 276.3443 can be configured in one of the following ways, depending on the selection you make in the *Screen Resolution* setup register:

Value	Screen Resolution
276.3443	1.x = 276.3
	1234.xx = 0276.34
	123456. = 000276.

If the *Screen Resolution* setup register is set to DEFAULT, the Display module will use the resolutions defined in the Display Options module.

Last digit mode

The Display module setup register *Last Digit Mode* lets you specify whether to truncate or round a value's last digit. Numbers round up at 5 or greater, and round down from 1 to 4. A truncated value disposes of any digits after the number of decimal places that you have specified in the *Screen Resolution* setup register.

Screen Resolution = 1.xxx

Value	=	276.35192
Rounded	=	276.352
Truncated	=	276.351

To configure parameter titles

The parameter value on a display screen is the value of an output connected to the Display module *Source* input register. By default, the displayed parameter's title is the name of the output connected to the *Source* input. The Display module *Source Title* setup register lets you change the default to a title that better describes your system. For example, if "KWh Net" is linked to the first *Source* input, you could change its display name by setting *Source 1 Title* to "KWh Net West." A maximum of 25 characters is permitted.

See "Changing TEST Mode Timeout" on page 186 for information on configuring TEST mode display timeouts.

Default Front Panel Display Screens

Each mode of operation (NORM, ALT and TEST) has its own display screens, providing various power system data and meter properties screens.

NORM mode display screens

The factory-configured ION 8800 meter scrolls through nine displays detailed below. If the settings in the Scroll module have not been altered, each screen is displayed for five seconds if no front panel buttons are pressed.

Display scrolling is suspended when a front panel button is pressed, and you can manually scroll through the display screens using the Up or Down arrow buttons. If required, refer to “Front Panel Features” on page 22 for more instructions on using the front panel buttons.

1. kWh
This screen displays kWh delivered and received values.
2. kvarh
This screen displays kvarh delivered and received values.
3. kVAh
This screen displays kVAh delivered and received values.
4. Peak Demand Delivered
This screen displays the maximum delivered kW value and a timestamp of when the peak occurred. This value is a Sliding Window (Rolling Block) demand calculation.
5. Peak Demand Received
This screen displays the maximum received kW value and a timestamp of when the peak occurred. This value is a Sliding Window (Rolling Block) demand calculation.
6. Peak Demand Reset Count
This screen displays a count of the number of Demand Resets executed as well as a timestamp of the latest Peak Demand Reset.
7. Q Metering
This screen displays approximated varh measurements, one phase (60 degrees) behind the normal watt-hour connection (90° - 330° and 150° - 270°).
8. kWh Disk Simulator
This display simulates the behavior of a mechanical watt-hour meter indicating power received or delivered by the direction of the pulse.
9. All Segments
This is a screen test where a black screen showing all segments (all pixels on) indicates that the display is functioning properly.

ALT mode default display screens

The meter scrolls through the following ALT mode displays. If the settings in the Scroll module have not been altered, each screen is displayed for five seconds if no front panel buttons are pressed (until five minutes have elapsed).

Viewing ALT display modes

1. Press the **Alt/Enter** button once to toggle between the NORM and ALT display modes.
2. Press the **Up** or **Down** arrow buttons to scroll back or forth through the displays.

If no buttons are pressed the meter reverts back to NORM mode after five minutes.

NOTE

These screens vary depending on the firmware version on the meter and custom display configuration.

◆ Name Plate 1

The Name Plate 1 screen contains this information:

- ◆ Owner
- ◆ TAG1 from Factory module
- ◆ TAG2 from Factory module
- ◆ Firmware revision of the meter
- ◆ Battery life indicator
- ◆ Meter serial number

TAG1 and TAG2 typically identify the meter's user and installed location. The Owner and TAG registers are configurable with ION software. See "How to TAG Your Meter" on page 38.

◆ Name Plate 2

This screen displays the following information for the current Sliding Window (Rolling Block) demand settings:

CONFIG	Length of the demand period multiplied by the number of demand periods
UPDATE	Length of the demand period
SYNC	Clock synchronization source
MAX (kW)	Maximum kW Demand ¹

- ¹ The MAX (kW) value is a maximum allowable demand level based on installed transformer configurations and nominal voltages and currents.

◆ Event Log

The Event Log screen displays up to four most recent, highest priority events (priority 255 only). The date, a timestamp, an event description, and an event code are provided for each event displayed.

If more than four high priority events have been recorded, then the Event Log screen will indicate additional logs exist. Refer to “Data Logging” on page 144 for more details.

◆ Vector Diagram

This screen shows phasors and numeric values for each phase current and phase voltage measurement.

◆ Instantaneous Voltage

This screen shows average voltage, line-to-neutral and/or line-to-line voltage (depending on the meter’s service type).

◆ Instantaneous Current

This screen shows the phase current and average current values.

◆ Instantaneous Power

This screen shows kW total, kvar total, kVA total and signed Power Factor total values.

◆ Instantaneous Demand

This screen shows kW delivered and received from the Sliding Window (Rolling Block) demand calculation.

◆ Availability

This screen shows the availability of power in a “number of nines” measurement, over a pre-set period of time.

◆ Voltage Harmonics

These screens show histograms of the per phase voltage harmonic content.

◆ Current Harmonics

These screens show histograms of the per phase current harmonic content.

◆ Instantaneous Demand

This screen shows kW delivered and received.

ALT mode Time of Use (TOU) display screens

Some ALT mode display screens are factory-configured to show Time of Use (TOU) data. The measurements displayed originate from frameworks of ION modules that are linked to a TOU module. For details about the TOU module, refer to the *ION Reference*.

By default, all demand values result from Sliding Window (Rolling Block) calculations.

◆ Active TOU Rate

This screen shows which of the valid TOU billing rates is active.

◆ Active TOU Season

This screen shows which TOU billing season is currently active.

◆ TOU Energy by Rate

This screen shows kWh delivered values for each TOU rate.

◆ kW Peak Demand

These screens display the maximum kW delivered value for each TOU rate. These values result from Sliding Window (Rolling Block) demand calculations.

◆ Past Billing Energy

This screen displays the kWh delivered values for each TOU rate in the previous billing period.

 **NOTE**

PB = Past (Previous) Billing period. A billing period is the time between two consecutive meter readings for billing purposes by a utility.

◆ Past Billing Peak Demand

These screens display the maximum kW delivered value for each TOU rate in the previous billing period. These values result from Sliding Window (Rolling Block) demand calculations.

◆ Past Season Energy

This screen displays the kWh delivered for each TOU rate in the previous billing season. These values result from Sliding Window (Rolling Block) demand calculations.

 **NOTE**

PS = Past (Previous) Season. Billing Seasons are defined in the TOU module description in the ION Reference.

◆ Past Season Peak Demand

These screens display the maximum kW delivered for each TOU rate in the previous billing season.

◆ Past Billing/Season Energy

These screens display the kWh delivered and received values in the previous billing period and billing season.

◆ Past Bill/ Season Pk Demand

These screens show the maximum kW sd received values in the previous billing period and billing season. These values result from a Sliding Window (Rolling Block) demand calculation.

◆ Past Billing/Season Energy

These screens display the kvarh delivered and received values in the previous billing period and billing season.

◆ Past Bill/Season Pk Demand

These screens display the kvar delivered and received values in the previous billing period and billing season. These values result from a Sliding Window (Rolling Block) demand calculation.

◆ Past Billing/Season Energy

These screens display the kVAh delivered and received values in the previous billing period and billing season.

- ◆ Past Bill/Season Pk Demand

These screens display the kVA delivered and received values in the previous billing period and billing season. These values result from a Sliding Window (Rolling Block) demand calculation.

- ◆ Frequency

This screen displays frequency information.

TEST mode default display screens

Values shown in the TEST mode display screens represent different accumulators than those shown in NORM mode (although they perform some of the same basic measurements). The TEST mode display values are for calibration checking purposes; they will only accumulate while the meter is in TEST mode.

Viewing TEST mode

There are two ways to switch the meter into TEST mode depending on the type of meter you have:

- ◆ Unlocked meter: You can use ION software or press a button on the front panel; refer to “Switching to TEST Mode” on page 183.
- ◆ Hardware-locked meter: You must open the cover on the meter and press the TEST Mode button.

Once the meter is in TEST mode the front panel cycles through three TEST mode display screens summarized below.

- ◆ kWh Test

This screen shows TEST mode kWh delivered and received values.

- ◆ kvarh/KVAh Test

This screen shows TEST mode kvarh/KVAh delivered and received values.

- ◆ Instantaneous Demand Test

This screen shows TEST mode kW delivered and received values. Both quantities are produced from a Sliding Window (Rolling Block) demand calculation. This value is reset if the Demand Reset button is pressed while the device is in TEST mode.

Chapter 16

TEST Mode

This chapter describes your meter's TEST mode and explains how to switch from Normal mode to TEST mode.

In This Chapter

◆ Introduction	182
◆ Switching to TEST Mode	183
Using the Front Panel (all meters)	183
Using ION Setup (unlocked meter)	183
Using ION Setup (hardware-locked meter)	184
Using Vista (unlocked meter)	184
Using Vista (hardware-locked meter)	185
◆ Changing TEST Mode Timeout	186
Using the front panel	186
Using ION Setup	186
Using Designer	187
◆ TEST Mode Default Display Screens	188
TEST mode LED energy pulsing	188

Introduction

TEST mode is typically used for verifying meter calibration and function. The meter is usually reading data from a test power supply while these functions are performed.

Several things to note about TEST mode:

- ◆ All of the billing quantities that are recorded when the meter is in normal mode will stop accumulating when the meter is switched to TEST mode — the data is sent to special TEST mode registers instead.
- ◆ The values accumulated in these test registers are displayed on the front panel and in ION software.
- ◆ The regular normal mode billing registers are unaffected while the meter is in TEST mode; accumulation of this data continues as soon as you exit TEST mode.
- ◆ All test registers are reset to zero when you exit TEST mode.

 **NOTE**

The meter will always return to NORM mode when you exit TEST mode, even if you entered TEST mode from ALT mode.

Switching to TEST Mode

Place the meter into TEST mode using the front panel, ION Setup or Vista. The meter's front panel informs you when the meter is in TEST mode with a special display screen.

NOTE

You cannot place a hardware-locked meter in TEST mode using ION software. The meter must be placed in TEST mode by pressing the TEST Mode button.

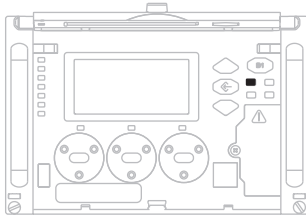

Using the Front Panel (all meters)

The TEST Mode button on the meter is located under the meter cover. You must open the cover to access. For sealed meters, you must first break the cover seal.

Once you have opened the outer cover, press the TEST Mode button.

Using ION Setup (unlocked meter)

1. Open ION Setup and connect to your meter, using Basic Mode.
2. In the Setup Assistant, navigate to the Verification folder.

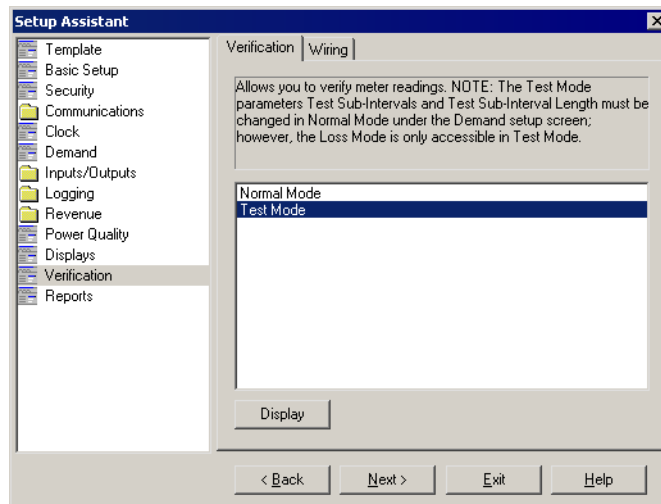

3. Click on TEST Mode. If meter security is enabled, you will be prompted for password. A dialog box informs you the meter is in TEST mode.



4. Click OK. The TEST Mode screen appears and test values are displayed.

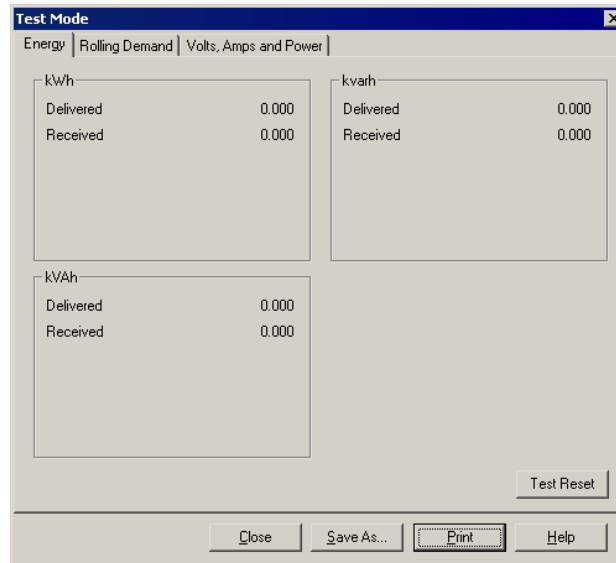

Click on the tabs to perform various test-related tasks. See the ION Setup online help for more information.

- Click Close. A dialog box informs you the meter is back in Normal Mode.



Using ION Setup (hardware-locked meter)

You cannot place a hardware-locked meter in TEST mode using ION software. The meter must be placed in TEST mode via the front panel. See “Switching to TEST Mode” on page 183.

Using Vista (unlocked meter)

- Open the meter in Vista.
- Navigate to System & Logs and click the Setup & Controls button in the Setup & Control section (bottom of screen).

3. Select the TEST Mode radio button. You will be prompted for the ION Enterprise user password. If standard meter security is enabled, you will also be prompted for the meter password.

Setup & Controls

Use the back button on the toolbar to get back to the main diagram

click radio buttons to change state

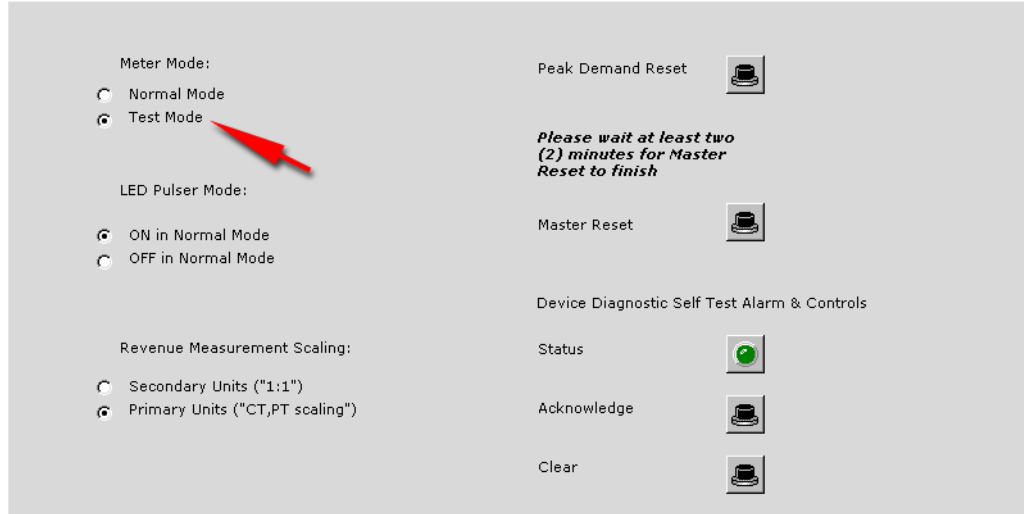

Use this screen to reset the registers that accumulate real-time data.

4. To view test mode values, navigate to the Revenue tab and click the Test Mode Values button.

Use the back button on the toolbar to get back to the main diagram

TEST MODE			
Energy			
	kWh	kvarh	kVAh
del	0	0	0
rec	0	0	0
del+rec	0	0	
Sliding Window Demand		Thermal Demand	
	kW		
del	Not Available	0	del
rec	Not Available	0	rec
del peak	Not Available	0	del peak
rec peak	Not Available	0	rec peak

For more information see the Vista section of the online *ION Enterprise Help*.

Using Vista (hardware-locked meter)

You cannot place a hardware-locked meter in TEST mode using ION software. The meter must be placed in TEST mode via the front panel. See “Switching to TEST Mode” on page 183.

Changing TEST Mode Timeout

If no front panel buttons are pressed, the meter will exit TEST mode after 30 minutes (unless the default TEST mode timeout value has been changed). While in TEST mode, the value on the bottom right of the status bar indicates the amount of time before TEST mode times out. The meter always returns to NORM mode when the TEST mode time-out elapses.

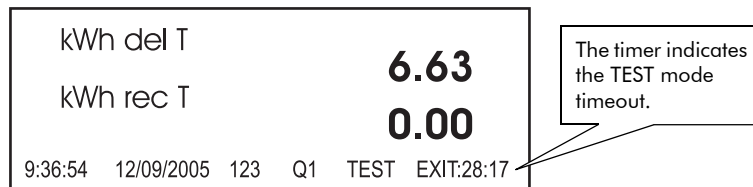

The time-out value resets to 30 minutes each time you press any front panel button. By default the TEST mode time-out value is 30 minutes.

You can change the value of the TEST mode time-out using ION software or the front panel.

Using the front panel

Follow these steps if you are using the front panel:

NOTE

On hardware-lockable meters, the meter must be unlocked to change the TEST mode timeout.

1. Enter the Setup menu by holding down the **Alt/Enter** button.
2. Scroll through the menu items, highlight DISPLAY OPTIONS, and press the **Alt/Enter** button.
3. Scroll down and highlight the TEST MODE TO menu item. Press **Alt/Enter**.
4. The current TEST mode time-out is displayed. Use the **Up** or **Down** arrow buttons to change the value of the highlighted digit. Press the **Up** or **Down** arrow button to change the position of the highlight cursor. When you have entered the new value of the TEST mode time-out in seconds, press the **Alt/Enter** button.
5. Select YES to Confirm the change, and enter the meter password if required.

Using ION Setup

Follow these steps if you are using ION Setup:

1. Start ION Setup and connect to the desired meter in Advanced Mode.
2. Locate the Display Options module in the module list and double-click to open the module.

3. In the Display Options module, click the Setup Registers tab and double-click the *TEST Mode Timeout* setup register. The default setting for this setup register is 1800 seconds (30 minutes).
4. Set the TEST mode timeout to the desired time. You can choose from a numeric bounded format or an elapsed interval format.
5. Click SEND to transmit the changes to the meter.

Using Designer

Follow these steps if you are using Designer:

1. Open Designer and connect to the desired meter.
2. Double-click the Display Setup folder on the Designer screen.
3. Right-click on the Display Options module to access the setup registers. Select the *TEST Mode Timeout* setup register and click Modify to edit.
4. Set the TEST mode timeout to the desired time. You can choose from a numeric bounded format or an elapsed interval format.
5. Click OK to send the changes to the meter.

TEST Mode Default Display Screens

Values shown in the TEST mode display screens represent different accumulators than those shown in NORM mode (although they perform some of the same basic measurements). The TEST mode display values are for calibration checking purposes; they will only accumulate while the meter is in TEST mode.

Once the meter is in TEST mode the front panel cycles through three TEST mode display screens:

1. kWh TEST

- ◆ This screen shows TEST mode kWh delivered and received values.

2. kvarh/KVAh TEST

- ◆ This screen shows TEST mode kvarh/KVAh delivered and received values.

3. Instantaneous Demand TEST

- ◆ These screens show TEST mode kW delivered and received values. Both quantities are produced from a Sliding Window (Rolling Block) demand calculation. This value is reset if the Demand Reset switch is turned while the device is in TEST mode.

TEST mode LED energy pulsing

Below the display screen are two pairs of energy pulsing LEDs and infrared outputs. The LEDs and IR outputs are factory-configured to pulse while the meter is in TEST mode.

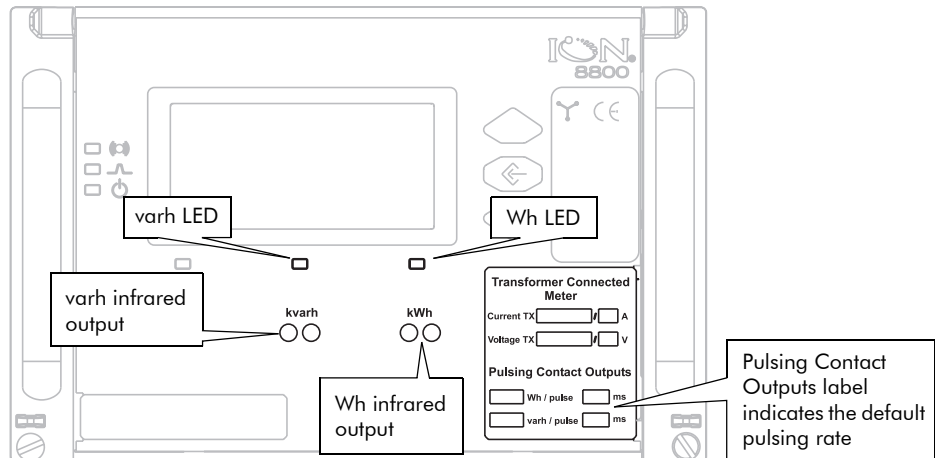

The energy pulsing LEDs provide an ideal interface for calibration checking instruments. The Pulsing Contact Outputs label (bottom right corner) indicates the factory-configured pulsing rate. (You can change the energy pulsing frequency with ION software.)

Refer to "TEST Mode" on page 30 for more information about using TEST mode.

Chapter
17

Resets

This chapter provides instructions for performing various meter resets.

In This Chapter

◆ Performing a Reset	190
Using the Front Panel	190
Performing a Master Reset from the front panel	190
Parameters affected by a Master Reset	190
Performing a Demand Reset from the front panel	191
Parameters affected by a Demand Reset	191
Using ION Setup	192
Using Vista	192
Master Resets and Hardware-locked Meters	193

Performing a Reset

Resets allow you to clear various accumulated parameters stored by the meter.

NOTE

Be sure to record any important data before performing a meter reset.

Using the Front Panel

The following resets can be performed via the front panel:

- ◆ Master Reset:
 - ◆ deletes most accumulated values and all derived revenue measurements from the meter.
- ◆ Demand Reset:
 - ◆ resets the peak demand values logged in the meter.

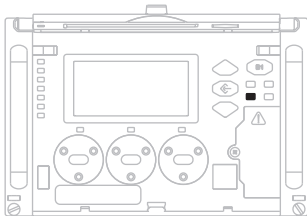

Performing a Master Reset from the front panel

The Master Reset button is recessed to avoid accidental activation. You must open the meter's cover before you can perform a Master Reset:

1. Remove the cover seal (if applicable).
2. Open the meter cover.
3. Using a small blunt non-marking instrument, press the Master Reset button.
4. At the confirmation screen, select Yes to confirm the reset.

CAUTION

After initiating a Master Reset, wait until the "Master Reset Completed" message appears on the front panel (or about two minutes, depending on your firmware). This allows the meter to completely reset parameters. This is especially important if you are powering down the meter after a Master Reset.

Parameters affected by a Master Reset

The Master Reset button resets many of the device's measurements and logs. The following parameters are reset to zero:

- ◆ Energy and Demand
- ◆ Peak Demand
- ◆ Loss Calculation
- ◆ Power Quality disturbance counters
- ◆ Time of Use

The following are cleared:

- ◆ Event Log
- ◆ All Data Recorders
- ◆ All Waveform Recorders

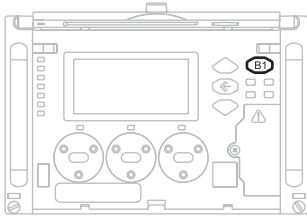

Performing a Demand Reset from the front panel

The Demand Reset button is recessed to avoid accidental activation. You must open the meter's cover before you can perform a Demand Reset:

1. Remove the cover seal (if applicable).
2. Open the meter cover.
3. Using a pencil or similar instrument, press the Demand Reset button.
4. At the confirmation screen, select Yes to confirm the reset.

Parameters affected by a Demand Reset

The mode that the meter is in (for example, NORM mode or TEST mode) defines the values that will be reset. The following parameters are reset to zero:

- ◆ Revenue Peak Demand
- ◆ TOU Peak Demand
- ◆ TOU Previous Billing Peak Demand
- ◆ Test Peak Demand

If *PkDemandMnMaxReset* is enabled, all long term Min \ Max values will also be reset. Note that this setting is disabled by default.

Demand Lockout Timeout

The setup register labeled *Demand Lockout Timeout* (Display Options module) sets the minimum time allowed between consecutive demand resets; the meter ignores any attempts to reset the demand outside the bounds of the register.

The default value for the Demand Lockout timeout is 25 days. For details on the Demand Lockout Timeout setup register, refer to "Demand Lockout Timeout" on page 15.

For more details on the Display Options module, see the *ION Reference*.

Using ION Setup

1. Open ION Setup and connect to your meter, using Basic Mode.
2. In the Setup Assistant, navigate to the Verification folder.
3. Select Normal Mode and click Display.

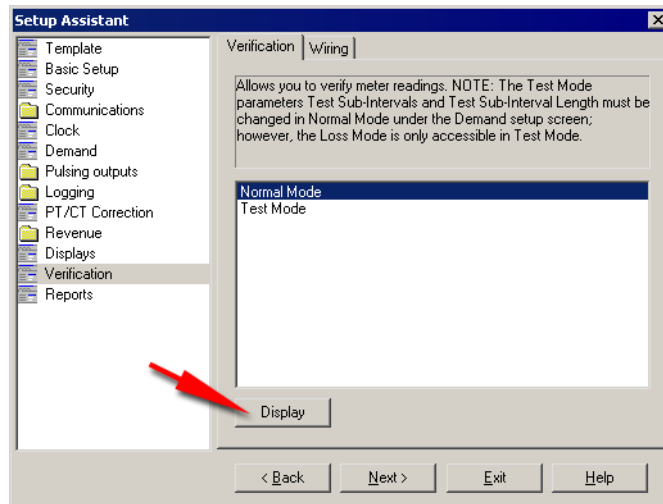

4. Click the various tabs to access the following reset buttons:
 - ◆ **Energy** - Master Reset
 - ◆ **Rolling Demand** - Peak Reset and Master Reset
 - ◆ **Volts, Amps and Power** - Master Reset
 - ◆ **Power Quality** - # of 9s Reset and Master Reset

NOTE

You can only perform a Master Reset via software on unlocked meters.

Using Vista

Open your meter in Vista. You can perform several resets from within Vista:

Performing a Peak Demand Reset or Master Reset

NOTE

You can only perform a Master Reset via software on unlocked meters.

1. Click the System & Logs tab and click the Setup & Control object.
2. Click the appropriate reset button to perform the reset.

Performing a Min/Max Reset

1. Click the Volts & Amps tab and click the Long-term Min/Max Measurements object.
2. Click the Min/Max reset button to perform the reset.

Performing a Sag/Swell, Availability or Harmonics Min/Max Reset

1. Click the Power Quality tab and click the Setup object.
2. Click the appropriate reset button to perform the reset.

Master Resets and Hardware-locked Meters

A master reset on a hardware-locked meter can only be performed from the front panel. The meter must also be unlocked first.

TEST Mode

In TEST mode, the following screen is displayed:



Chapter
18

Alerting

ION alerts can send an email or contact a modem, fax, pager, or software in the event of a user-specified condition. These conditions can be changes in relays or power quality problems including surges, sags, swells and outages.

This chapter explains how to configure your meter network for alerting.

In This Chapter

◆ Alerting	196
Alerting ION Software via the Alarm Server	196
Remote Site Event Notification	197
Alerting via an Alphanumeric Pager	197
Alerting via a Numeric Pager	198
Alerting via Email	199
Alert Module Settings	200

Alerting

The meter's Alert module sends an alert whenever its *Trigger* input is pulsed. You can connect this input to any module that produces a pulse output. You can use modules that monitor alarm conditions such as changes in relay status and power quality problems. For example, you can connect the *Trigger* input to the output of a Setpoint module, thereby allowing the Alert module to send an alert when the setpoint condition is reached.

The Alert module delivers these types of alerts:

- ◆ Numeric Pager
- ◆ Alphanumeric Pager
- ◆ PEGASYS (for alerts to PEGASYS software)
- ◆ ION Alert (for alerts to ION Enterprise software)
- ◆ ASCII
- ◆ Email

Selection between modes is made with the Alert module *Alert Type* setup register.

The Alert module requires access to either a modem (a dedicated modem or a modem handling a loop of meters) or Ethernet (for the Alert module email capabilities).

Your meter has no pre-configured Alert framework. For detailed information about alerting, including how to build a framework to send alerts, refer to the Alert module description in the *ION Reference*.

Alerting ION Software via the Alarm Server

NOTE

For detailed information about sending alerts to ION Enterprise software via the Alarm Server, refer to the ION Enterprise online help.

The Alarm Server can run on any ION software Primary or Secondary server. The server computer should have a dedicated phone line and modem. Modems at remote sites are programmed to dial the server's phone number when a priority event occurs. The Alarm Server monitors the phone line and waits for the remote sites to annunciate events. The most common use of the Alarm Server is to handle Remote Site Event Notification.

Remote Site Event Notification

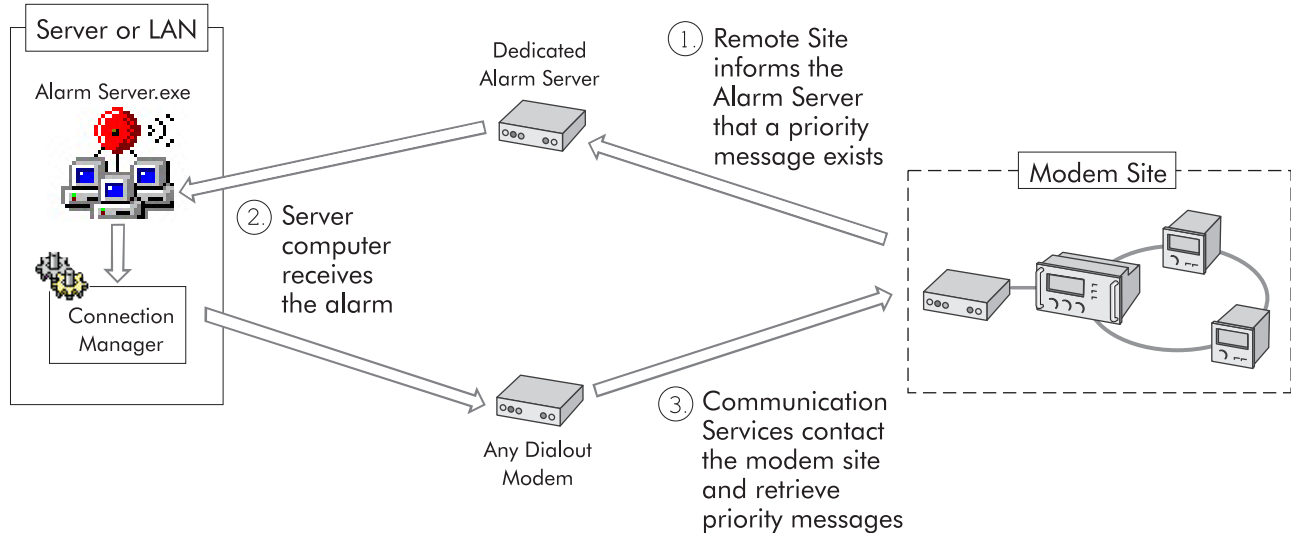

The Alarm Server uses a series of command line arguments to specify the actions it takes when a priority event is reported. These commands must be entered on the computer that is running the Alarm Server utility. Typically the Alarm Server is configured to launch the Connection Manager, which dials up the remote site and retrieves the logs from the devices. The Alarm Server can also be configured to launch other applications. A series of parameter switches are added to the command line to pass information about the event to the application that is launched.

Configuring the Alarm Server

The Alarm Server should have a dedicated phone line, modem, and COM port to avoid conflicts with other ION software components.

The modem used by the Alarm Server is **not** configured with the Management Console; only dialout modems are configured in the Management Console. The Alarm Server's executable, `alarmsrv.exe`, is typically located in `\\Power Measurement\ION Enterprise\SYSTEM\bin`. You can run the Alarm Server in a console window, or you can define a shortcut icon that includes all of the command line arguments required.

Alarm Server Command Line Arguments

Refer to the *ION Meter Alerts* technical note for a list of command lines that the Alarm Server supports.

Alerting via an Alphanumeric Pager

NOTE

For detailed information about building a framework for alerting via an alphanumeric pager, refer to the Alert module description in the online *ION Reference*.

If an alphanumeric pager is specified as the destination address in the Alert module, then an alphanumeric paging service receives a message from the ION meter.

Once the modem at the paging service is contacted, the ION meter transmits the following information:

- ◆ Pager identification number
- ◆ Local time (year, month, date, hours, minutes, seconds)
- ◆ Remote site identification
- ◆ Priority of the alarm
- ◆ Alert message, with text strings and realtime measured values

To include a module's *Source* input in the message, reference the message string by using the form %Vn, where n is the *Source* input number. In the following *Message* register setting, the kWtot value is %V1. The string includes *Source* input 1 which would be the kWtot register from the Power Meter module.

The destination register contains your modem access number for the paging service provider and is what is dialed out first. The *Pager Num* register is the pager access number that is provided by your paging company.

Alerting via a Numeric Pager

NOTE

For detailed information about building a framework for alerting via a numeric pager, refer to the Alert module description in the online *ION Reference*.

If a numeric pager is specified as the destination address in the Alert module, then a numeric paging service receives a message from the ION meter. Due to the inherent limitations in numeric paging, the ION meter can only send a string of digits to the paging service. The Alert module then waits a specified time, determined by the number of commas inserted after the phone number in the *Pager Num* setup register. Finally, the Alert module dials the message digital string.

There are two important factors to consider when setting up the Alert module for numeric paging. First, be sure to specify a string of digits that is meaningful to you, such as a coded message. Second, be aware that there is no way to ensure that a message has been successfully transmitted; there may be a busy signal or an answering machine may take the call. The number of commas you add to your dial string is an estimate of how long the modem at the remote site waits before it transmits numbers.

Alerting via Email

NOTE

For detailed information about setting up your network and building a framework for meter email (MeterM@il) alerts, refer to the technical note *ION MeterM@il*.

If email is specified as the destination address in the Alert module then an email message is sent to any address you specify. You can only set one email address per Alert module. If you want to send an alert to more than one email address you need to create a group — be sure your email server is configured to send email to groups via SMTP (Simple Message Transport Protocol).

Follow the steps below to send email alerts from your meter. Note that your meter must support emailing (with a correctly configured SMTP server):

1. Create an Alert module.
2. Configure these Alert module setup registers as indicated:
 - ◆ *Message* – type in the text of the alert to be emailed.
 - ◆ *Destination* – type in the destination email address.
 - ◆ *Type* – select Email.
 - ◆ *Com Port* – select Ethernet.
 - ◆ *Location* – type in a custom string; this is optional, and appears in the email.
 - ◆ *Email From* – type in an address that you want the email to appear from. This may be required as some SMTP servers only accept emails from valid addresses.
3. Create an ION module that will produce a pulse on its *Trigger* output when the exceptional event occurs (for example, a Setpoint module pulses its *Trigger* output when the setpoint condition is reached).
4. Link the Alert module's *Trigger* input to the *Trigger* output of the module created in step 3.
5. Click Send and Save. When the *Trigger* input is pulsed, the Alert module establishes communications with the SMTP mail server, and emails the alert message.

Alert Module Settings

Alert modules are not pre-configured and must be created and setup for your meter's alarming functionality to work correctly. See below for details.

Setup Register	Description
Message	This text will appear on the pager or in the email.
Priority	Allows you to set an alert's priority, from 0 (lowest priority) to 255 (highest priority)
Destination	Identifies the alert's destination: Modem - this is the dialing string Email - this is the email address
Type	Specifies the type of alert: Email, ASCII, Alphanumeric Pager, Numeric Pager, Pegasys or ION Alert
PagerNum	The pager access number.
Com Port	Specifies the communications port used to send the alert.
Attempts	Sets the number of times that the module attempts to connect.
Retry Time	If the modem is unable to establish communications on the first attempt, this sets the amount of time (in seconds) the module waits before attempting to dial again.
Lockout Time	For successfully sent alerts, this specifies a period that all Alert modules wait before another alert transmission can begin.
Location	Identifies the meter that is sending the alert (ION Alerts only).
ModemInit	The initialization string used by the modem while the alert is being sent.
Email From	Specifies the email address that appears in the From: field on the email.

Chapter
19

Setpoints

This chapter provides instructions for configuring meter setpoints.

In This Chapter

◆ Introduction	202
◆ Configuring Setpoints	202
Using the Front Panel	202
Using ION Setup	202
Using Vista	202
Relative Setpoint Module Settings	203
Fine Tuning Over Condition Monitoring	203

Introduction

The Relative Setpoint module provides extensive control, secondary protection, and analysis capabilities by allowing you to initiate an action in response to a specific condition. It is particularly useful for performing actions based on differences between a value (e.g. kW on phase 1) relative to a reference value (e.g. kW demand for all three phases). Use this module's outputs for demand control of equipment or any other applications requiring setpoint activity relative to a varying value. See the *ION Reference* for more information on the Relative Setpoint module.

Configuring Setpoints

Use ION software to change your meter's setpoints.

Using the Front Panel









You cannot configure Setpoints using the front panel.

Using ION Setup

1. Connect to your meter in ION Setup, using Advanced Mode.
2. Click on the Relative Setpoint module you wish to configure.

Using Vista

Open your meter in Vista, and click on the Setpoints tab. Click the Setup grouping object. Use the switches to turn various monitoring on and off (see circled below). Click the numeric boxes to edit condition settings.

<p>Over kW SWDemand</p> <p>Annunciate if the total kW SWDemand exceeds <input type="text" value="0"/> kW</p> <p>Enable Over Demand Setpoint  Click to change value, then press Enter</p>	<p>Status  Demand <input type="text" value="1 kW"/></p>
<p>Over Current on phase 1, 2, 3</p> <p>Annunciate if the current on phase 1 exceeds <input type="text" value="0"/> A</p> <p>Annunciate if the current on phase 2 exceeds <input type="text" value="0"/> A</p> <p>Annunciate if the current on phase 3 exceeds <input type="text" value="0"/> A</p> <p>Over I a,b,c </p>	<p>Status</p> <p> I1 <input type="text" value="4 A"/></p> <p> I2 <input type="text" value="5 A"/></p> <p> I3 <input type="text" value="4 A"/></p>
<p>Over Voltage unbalance</p> <p>Annunciate if the Voltage unbalance exceeds <input type="text" value="0"/> %</p> <p>Enable Over U unbal Setpoint </p>	<p>Status  U unbal <input type="text" value="0.1 %"/></p>

Relative Setpoint Module Settings

Several Relative Setpoint modules monitor the following for “over” conditions: phase current, kW demand, and voltage unbalance. Other modules are used only for EN50160 operation. See below for details.

Module	Label	Description
Relative Setpoint 1	Over KW sd	When active, this annunciates when the total kW SWDemand exceeds a specified amount.
Relative Setpoint 2	Over I 1	When active, this annunciates when the current on phase 1 exceeds a specified amount.
Relative Setpoint 3	Over I 2	When active, this annunciates when the current on phase 2 exceeds a specified amount.
Relative Setpoint 4	Over I 3	When active, this annunciates when the current on phase 3 exceeds a specified amount.
Relative Setpoint 5	Over U unbal	When active, this annunciates if the voltage unbalance exceeds a specified percentage.
Relative Setpoint 6-14	<voltage phase> (+/-15%) - <time period>	These nine modules are used for EN50160 operation. For more information, see the <i>Power Quality: ION Meters and EN50160</i> technical note.

NOTE

There is usually no need to change any of the Relative Setpoint modules' setup registers for normal operation of the meter.

See the *ION Reference* for more information on the Relative Setpoint module.

Fine Tuning Over Condition Monitoring

If you want to fine-tune over condition monitoring, the only setup registers you should change are *SusUntION* and *SusUntIOFF*.

SusUntION determines how long the modules wait after an over condition is detected before reporting it. This gives the monitored value a short period to correct itself before the event is registered with the module so that very brief over conditions are ignored. Similarly, *SusUntIOFF* is the amount of time a normal value must be present before the module considers normal operation to be restored. Both *SusUntION* and *SusUntIOFF* values are entered in seconds (the default value for both is 30 seconds).

Chapter
20

Power Availability

ION 8800A and B meters come pre-configured with a power availability framework that provides reliability measurements using “number of nines” calculations.

While the Availability Framework is pre-configured, the operation of this framework requires the correct configuration of the Sag (Dip)/Swell module according to your meter’s power supply and operating ranges. See “Sag/Swell Module Configuration” on page 208. See also the *ION Reference* for detailed descriptions of this module.

In This Chapter

◆ Introduction	206
◆ Availability on the Meter Front Panel	207
Sample Availability Framework Behaviors	207
Sag/Swell Module Configuration	208
Resetting and Pausing Power Availability	208
◆ Detailed Behavior	211

Introduction

Power availability predicts, based on historical data, the probability that a specific power system will be functioning in its correct state at some point in the future. The availability calculation measures the time that power was available at the meter's monitoring point. This value can be used alone or incorporated with other reliability calculations.

Typically, a utility distribution system provides an availability of approximately 99.9%. Many applications require better availability than this: up to 99.9999% or better. At this level, the number of consecutive nines becomes difficult to determine at a glance. High levels of availability are commonly referred to as "Number of Nines": 99.9% corresponds to 3 nines; 99.9999% is 6 nines.

Once the meter is installed, the availability calculations must be reset to ensure valid time counts. You can reset availability calculations using ION software. You can also pause availability calculations for meter maintenance or decommissioning purposes (refer to "Resetting and Pausing Power Availability" on page 208).

Availability on the Meter Front Panel

The following power availability values display on the meter's front panel, and are viewable in the Vista component of ION Enterprise or ION Setup software:

- ◆ **Number of Nines:** the number of consecutive nines that appear in the most-significant digits of the availability value (e.g. "10" on the front panel indicates 10 nines: 99.99999999).
- ◆ **Availability-ppm:** the fraction of time that the power is available, in parts per million (ppm).
- ◆ **Evaluation Time (days):** the number of days that have elapsed since the calculation was last reset. This gives an indication of the time interval over which the availability calculation is made.

The availability framework is found at this location within Designer: Advanced Setup\Power Quality Framework\Power Availability Framework.

Sample Availability Framework Behaviors

Scenario 1: 3-phase powered meter + power system outage

The Sag/Swell total disturbance time includes the outage. The meter downtime from the diagnostics module is added to the meter uptime to account for the total time of observation.

Scenario 2: 3-phase powered meter + meter decommissioned

The Sag/Swell module logs the downtime as disturbance time. When the meter powers back up, the meter downtime from the diagnostics module is added to the meter uptime.

Scenario 3: single-phase powered meter + power system outage

The Sag/Swell total disturbance time includes the outage. The meter never loses power, which means that there is no meter downtime and the meter uptime is equivalent to the total time of observation.

Scenario 4: single-phase powered meter + meter decommissioned

The Sag/Swell module does not log a disturbance time. When the meter powers back up, the meter downtime from the diagnostics module is added to the meter uptime.

Assumptions

The above scenarios assume that:

1. The single-phase powered meter assumed the power system was within specs during a meter down time if it didn't detect a disturbance prior to powering down.
2. The Sag/Swell module is configured correctly to monitor voltage disturbances.
3. The Sag limit is set above the voltage level at which the meter starts powering down.

4. An single-phase powered meter is used for applications that require a highly accurate measurement of power system downtime.

Sag/Swell Module Configuration

Your meter's power availability framework requires that the Sag/Swell module be configured to the limits of your meter's power supply specification.

For the most current specifications, see the *ION 8800 Installation Guide*.

See the *ION Reference* for detailed information on the operation of the Sag/Swell module.

The IEC 61000-4-30 standard recommends sag (dip) and swell limits of 90% and 110% respectively.

Resetting and Pausing Power Availability

The power availability framework in the ION 8800 meter allows the user to pause or reset its operation. The framework can be paused and reset with ION software.

Using the Front Panel

You cannot reset availability using the meter's front panel.

Using ION Setup

With ION Setup software, you can reset availability calculations by clicking on the button labeled "# of 9s Reset" in the Verification > Normal Mode > Power Quality tab.

1. Launch ION Setup software and double-click the Setup Assistant.
2. Click on the Verification setup screen, and from that screen, double-click Normal Mode.
3. In the Normal Mode screen, click the Power Quality tab.

- In the Power Quality screen, click the button labeled “# of 9s Reset” to reset availability calculations. Provide a password (if requested), and click OK.

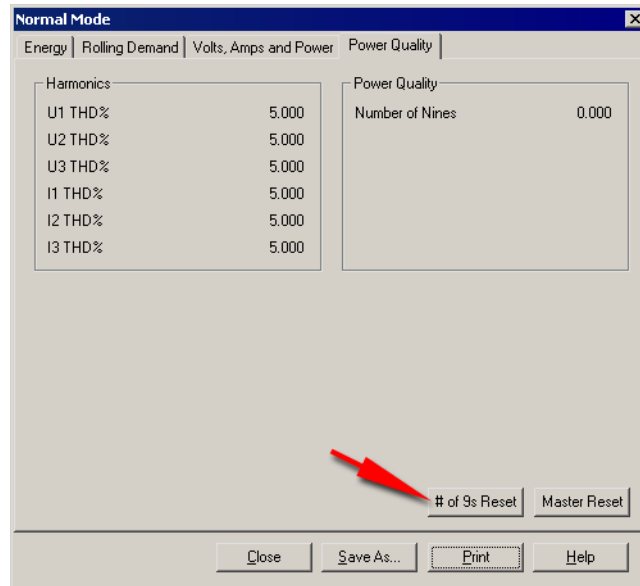

Using Vista

With Vista software, you can manually reset availability calculations. A meter is typically reset after installation to ensure valid time counts.

Open your meter in Vista, and click on the Power Quality tab. Click the Setup grouping object. On the Power Quality Controls screen, click the Reset Availability Statistics button (see circled below).

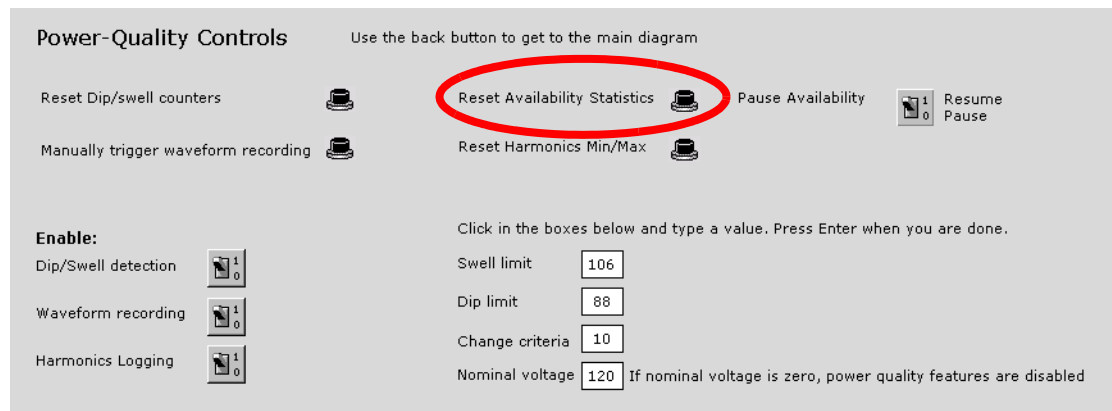

NOTE

To ensure correct availability calculations, do not reset during a sag (dip) or swell.

Pausing Availability

The availability framework allows a user to temporarily pause the meter uptime counter and ignore any meter downtime and disturbance time. This allows a user to decommission the meter without affecting the availability statistics. Availability statistics are also paused when the Availability framework is “turned off.” Note the “Pause Availability” switch on the graphic below.

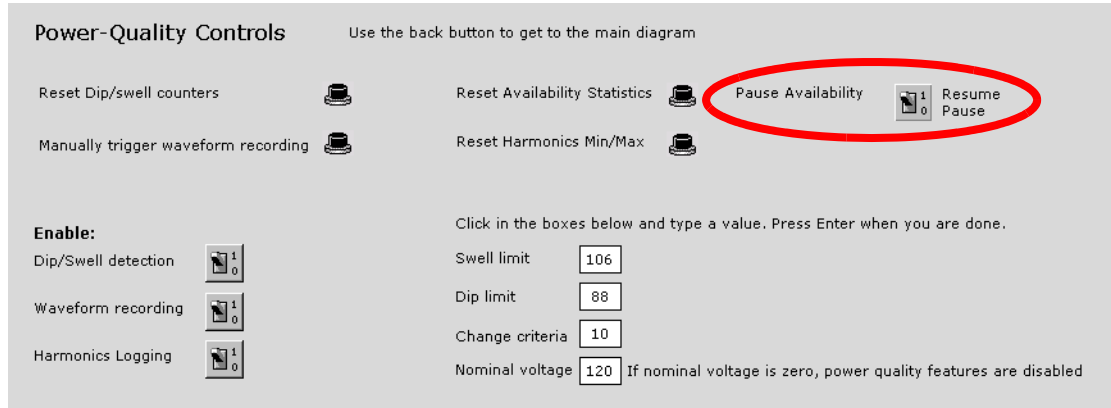

Detailed Behavior

The Availability framework measures Disturbance time from the Sag/Swell module, Uptime from a counter module and meter Downtime from the Diagnostics module. Meter Downtime is added to the Uptime count to provide the total time of observation.

The meter uses three measurements when calculating the availability:

1. **Meter Uptime:** the time the meter is powered and actively monitoring. The time is measured by counting 1-second pulses from a Periodic Timer module.
2. **Meter Downtime:** this time is measured by the meter's internal clock and made available through the diagnostics module. The diagnostics module downtime register is updated on each power up. This calculation is accurate across a single month boundary: any additional month boundaries are assumed to have 30 days. You must set the Sag (dip) limit above the minimum voltage level specific to the power supply and wiring configuration of the meter (see "Sag/Swell Module Configuration" on page 208). If there is no control power then it is assumed there is no power anywhere, and this time counts against availability.

When the meter powers up, it takes about 15 seconds before the ION modules are operational again. This power up time counts against the availability (a single power up per year limits total availability to 6 nines). If the application requires better resolution than this, then a UPS or other auxiliary power supply for the meter should be considered.

If the meter or control power circuit is taken out of service for maintenance, you can disable the measurement of meter downtime with ION software; see "Pausing Availability" on page 210.

Number of Nines	ppm (% x 10,000)	Downtime (seconds/year)	Downtime per year
1	90%	3153600	36.5 days
2	99%	315360	3.7 days
3	99.9%	31536	8.8 hours
4	99.99%	3153.6	52.6 minutes
5	99.999%	315.36	5.3 minutes
6	99.9999%	31.536	31.5 seconds
7	99.99999%	3.153599998	3.2 seconds
8	99.999999%	.3153599998	.32 seconds
9	99.9999999%	.03153599998	.032 seconds
10	99.99999999%	.003153599998	.0032 seconds

3. **Voltage Disturbance Duration:** the total number of seconds that the voltage was outside the envelope determined by the Sag/Swell module. If several sags or swells occur during one second, only the last one counts toward the total. The Sag/Swell module settings may be used to control the voltage tolerance. If the Sag/Swell module is not enabled, no voltage disturbances are counted.

Terminology

- ◆ **3-phase powered meter:** the power to run the meter is derived from the Voltage input terminals that are connected to the monitored system. The meter loses power if the monitored system is down.
- ◆ **Single-phase powered meter:** The power to run the meter is derived from an independent power source. The meter remains powered when the monitored system is down.
- ◆ **Meter uptime:** the time the meter is powered and actively monitoring. The time is measured by counting 1-second pulses from a Periodic Timer module.
- ◆ **Meter downtime:** the time the meter is not powered. This time is measured by the meter's internal clock and made available through the diagnostics module. The diagnostics module downtime register is reset at the beginning of each outage.
- ◆ **Availability:** the probability of finding a system in the operating state at some time into the future. Availability is calculated as:

$$\begin{aligned} \text{Availability} &= \frac{\text{Time the power system is operating within specifications}}{\text{Total time of operation}^*} \\ &= \frac{\text{Meter uptime} - \text{disturbance time}}{\text{Meter uptime} + \text{meter downtime}} \end{aligned}$$

* Where total time of observation = uptime + meter downtime

- ◆ **Unavailability:** calculated in the framework and then converted to number of nines, and Availability in percent and parts per million (ppm):

$$\begin{aligned} \text{Unavailability} &= \frac{\text{Time the power system is operating outside specifications}}{\text{Total time of operation}^*} \\ &= \frac{\text{Disturbance time}}{\text{Meter uptime} + \text{meter downtime}} \end{aligned}$$

* Where total time of observation = uptime + meter downtime

Chapter
21

Reports

This chapter provides instructions for viewing various meter reports and logs.

In This Chapter

- ◆ **Introduction** **214**
- ◆ **Viewing Meter Logs** **214**
 - Using the Front Panel 214
 - Using ION Setup 214
 - Using Vista 216

Introduction

Accumulated meter values are saved in logs. These **logs** are acquired by your energy management software (ION Enterprise or third-party) and saved in its database for analysis and reporting.

The Reporter component of ION Enterprise is a database reporting application that lets you define, generate, and manage comprehensive **reports** based on the information in your system database. It processes selected data and generates a finished report in Microsoft Excel 2000 format.

For more information on reports, see the Reporter section of the online *ION Enterprise Help*.

Viewing Meter Logs

View meter logs using ION software or the front panel.

Using the Front Panel

The front panel only displays recent high priority events (Event Log screen).

DATE	TIME	EVENT	CODE
12/08/2005	10:23:45	Shutdown	SD25
12/08/2005	10:42:03	Power Up	SD25
12/08/2005	11:19:26	Changed Setup	SD25
VIEW EVENT LOG THROUGH COMMUNICATIONS			
9:36:54	12/09/2005	123	Q1 NORM <input type="checkbox"/>

Press the **Up** and **Down** buttons to navigate to the Event Log.

Using ION Setup

Display various meter logs or reports using the Report Assistant.

1. Open ION Setup and connect to your meter, using Basic Mode.

- In the Setup Assistant, navigate to the Reports folder.

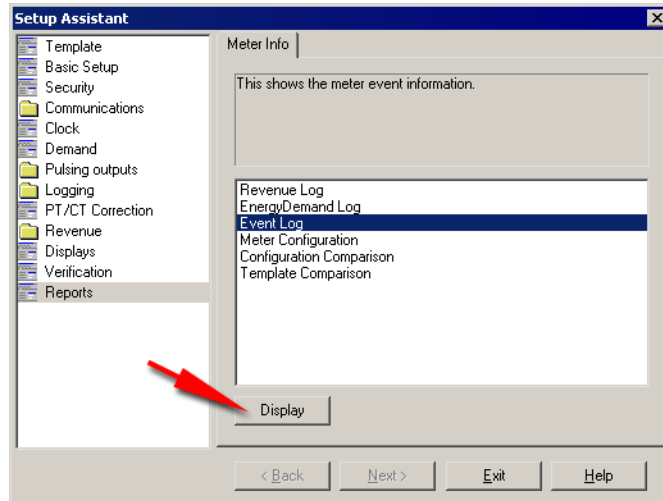

- Select one of the logs or comparisons in the list and click Display to view the associated log.
- Select which records you want to view (all, specific number or date range) and click OK.



Below is an example of an Events Log.

Date/Time	Cause	Value	Effect	Value
15/11/2004 1:23:12.583 PM	Front Panel	Changed Setup	SD39 Sub Intvl	900
15/11/2004 1:23:12.884 PM	Front Panel	Changed Setup	SD40 Sub Intvl	900
15/11/2004 1:23:13.045 PM	Front Panel	Changed Setup	SD41 Sub Intvl	900
15/11/2004 1:23:13.444 PM	Front Panel	Changed Setup	SD42 Sub Intvl	900
15/11/2004 1:23:13.675 PM	Front Panel	Changed Setup	SD43 Sub Intvl	900
15/11/2004 1:23:13.912 PM	Front Panel	Changed Setup	SD44 Sub Intvl	900
15/11/2004 1:23:14.310 PM	Front Panel	Changed Setup	SD45 Sub Intvl	900
15/11/2004 1:23:14.476 PM	Front Panel	Changed Setup	SD46 Sub Intvl	900
15/11/2004 1:23:14.777 PM	Front Panel	Changed Setup	SD47 Sub Intvl	900
15/11/2004 1:23:14.953 PM	Front Panel	Changed Setup	SD48 Sub Intvl	900
15/11/2004 1:23:15.353 PM	Front Panel	Changed Setup	SD49 Sub Intvl	900
15/11/2004 1:23:15.586 PM	Front Panel	Changed Setup	SD50 Sub Intvl	900
15/11/2004 1:23:15.812 PM	Front Panel	Changed Setup	SD51 Sub Intvl	900
15/11/2004 1:23:15.993 PM	Front Panel	Changed Setup	SD52 Sub Intvl	900
15/11/2004 1:23:16.386 PM	Front Panel	Changed Setup	SD53 Sub Intvl	900
15/11/2004 1:23:16.552 PM	Front Panel	Changed Setup	SD54 Sub Intvl	900
15/11/2004 1:23:16.850 PM	Front Panel	Changed Setup	SD55 Sub Intvl	900
15/11/2004 1:23:16.951 PM	Front Panel	Changed Setup	SD56 Sub Intvl	900

- You can view, save or print the log. Click Close to exit.

Using Vista

Open your meter in Vista and click on the various tabs available. Click a grouping object to view the associated logs. The following logs are available in Vista:

- ◆ System & Logs tab:
 - ◆ Voltage
 - ◆ Current
 - ◆ Power
 - ◆ Power factor / Frequency
 - ◆ Revenue data
 - ◆ Meter events
- ◆ Power Quality tab:
 - ◆ Harmonics trending
 - ◆ Dip/Swell statistics CBEMA
 - ◆ Waveforms/Sequence of Events (if supported)
 - ◆ Transient (if supported)
 - ◆ EN50160 (if supported)

Chapter
22

Verifying Accuracy

All ION 8800 meters are tested and verified at the factory according to ANSI and IEC (International Electrotechnical Commission) standards; however, before a new revenue meter is installed it is important to perform a final accuracy verification.

ION meters are digital and do not require calibration, only verification of their accuracy. This chapter outlines a procedure for accuracy testing ION 8800 meters.

In This Chapter

◆ Introduction	218
Accuracy Standards	218
Current Ranges	218
Testing Overview	218
◆ Test Procedure	220
◆ Connecting the Test Harness	221
◆ Connecting the Control Equipment	222
Using the LEDs	222
Using the Digital Outputs	222
◆ Configuring Test Settings	223
Digital Outputs settings	223
LED pulser settings	223
Changing the energy pulse rate from the Front Panel	223
Changing the energy pulse rate in ION Setup	223
Changing the energy pulse rate in Designer	224
Test Points	224

Introduction

The revenue-accurate ION meter is digital and therefore needs no servicing. It is tested for accuracy at the factory and remains accurate for the life of the meter. In contrast, electro-mechanical meters need mechanical adjustment before installation and periodic calibration thereafter. This procedure of 'calibration testing' is unnecessary for digital meters.

Digital meters require 'accuracy' testing, or verification to ensure the meter meets required accuracy specification. If you know your meter is within required accuracy specification before installation, errors observed in the field could be attributed to incorrect connections or instrument transformer ratio settings.

Accuracy Standards

The meter conforms to the following accuracy standards:

- ◆ IEC 62053-22 Class 0.2S (for 1A and 5A)
- ◆ ANSI C12.20 Class 0.2

Current Ranges

The meter meets the following current ranges:

- ◆ Compatible with CTs in the range of 10 mA to 10A
- ◆ Over-range current of 14 A
- ◆ Starting current of 1 mA

DANGER

During normal operation of the meter, hazardous voltages are present which can cause severe injury or death. These voltages are present on the connector pins of the device and throughout the connected potential transformer (PT), current transformer (CT), status input, relay, and control power circuits. Only qualified, properly trained personnel should perform installation and servicing.

Testing Overview

The most common method for testing meters is to inject voltage and current from a stable power source in combination with a reference meter. Although meter shops use different methods for testing revenue meters, most test equipment requirements are similar. The sections below provide an overview and some test equipment guidelines for verifying the accuracy of your ION 8800.

Test harness

A test harness is essential for non-socket meters. Ensure that the test harness for the meter is wired properly. The current and voltage transformers must be accurately rated and must perform within specifications to provide accurate results.

Power source

It is important to have a steady power source. Power that energizes the meter must be reliable and provide: the rated voltage of the meter, unity power factor (1) and lagging power factor of 0.0 (for varh testing) or 0.5.

Test loads

There are three methods of current loading: customer's load (a meter in service), resistance load (characteristics similar to a lighting load), phantom loading (a test board). Your test load device or other loading circuit must be set within the current capacity ranges for the meter. The procedure outlined in this technical note describes verification using a phantom load or test board.

Control equipment

Control equipment is required for counting and timing the pulse outputs (revolutions) from the front panel LEDs. Most standard test benches have an arm with infrared sensors used for this purpose.

Environment

The meter should be tested at the same temperature as the testing equipment. The ideal temperature is about 22°C (72°F). Ensure the meter is warmed-up sufficiently before testing (at least 30 minutes).

 **NOTE**

Ensure the accuracy and precision of any measurement equipment you use (i.e. voltmeters, ammeters, power factor meters).

Test Procedure

The following are guidelines for testing the meter. Your meter shop may have other testing methods:

1. Place the meter into the test harness or other standard measuring device. Ensure all voltages are in parallel with the meter being tested and all currents are in series (see “Connecting the Test Harness” on page 221).
2. Connect the control equipment used for switching the voltage to the test standard device.
3. Connect the control equipment used for counting the standard output pulses using either method:
 - ◆ align the infrared sensor on the standard test bench armature over the appropriate front panel LED pulser (Wh or varh).

OR

- ◆ connect to the meter’s digital outputs (see “Connecting the Control Equipment” on page 222).
4. Apply the rated current and voltage to the terminals of the meter.
 5. Before performing the verification test, let the test equipment power up the meter. Apply voltage for at least 20 seconds. The warm-up allows the internal circuitry and capacitors to stabilize.
 6. Set the meter’s volts mode to 4W-WYE.
 7. You may choose to place the meter in test mode (see Test Mode chapter for more details). This allows the meter to enter the field with no Wh values in the registers. If you are performing field testing, put the meter in test mode to avoid incorrect customer billing.
 8. Perform testing on the test points (see “Test Points” on page 224).
 9. Run each test point for at least five seconds to allow the test bench equipment to read an adequate number of pulses. Allow three seconds of dwell time between test points.

Connecting the Test Harness

WECO model 8CA-1 adapter provides an easy means of connecting an ION 8800 meter to a WECO test machine.

1. Connect the harness wires to the meter's voltage and current inputs. See below for details:

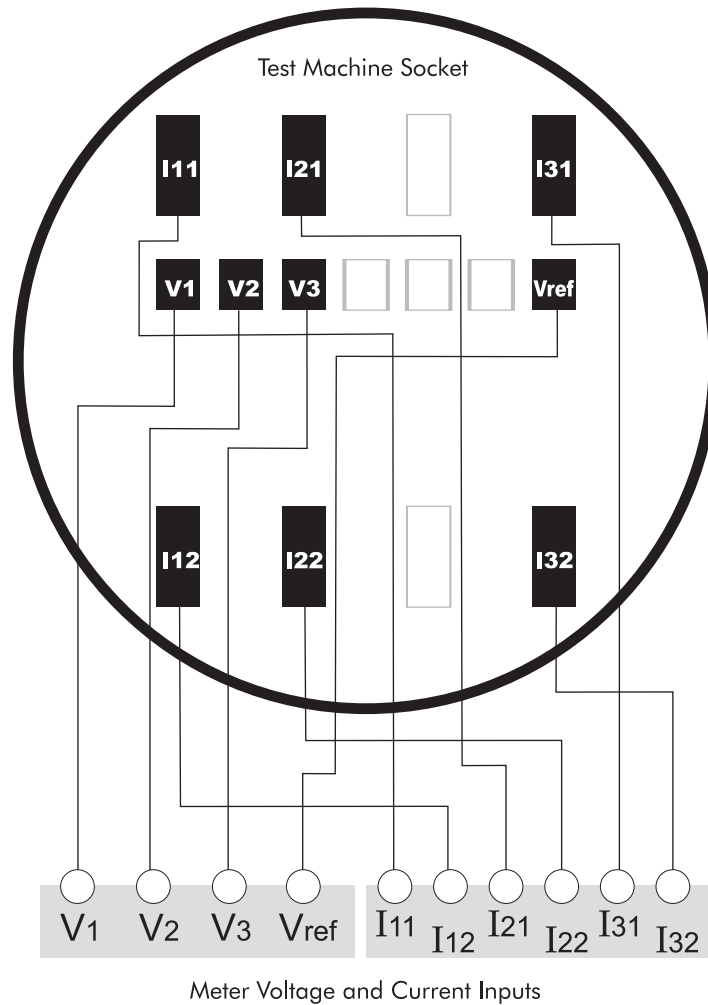

2. Plug the adapter into the WECO test machine's socket.
3. Set the WECO machine to **9S**.

Connecting the Control Equipment

You can use either the meter's front panel LEDs or the digital outputs for control purposes.

Using the LEDs

1. Carefully position the test machine's optical arm over the applicable LED pulser (Wh or varh).
2. Set test machine to "adjust optics" and ensure that LED pulses are being read.

Using the Digital Outputs

Connect the meter's Form C solid-state digital outputs to the WECO test machine. The Essailec connectors are found on the rear of the meter. See your meter's Installation Guide for details on your specific I/O wiring configuration.

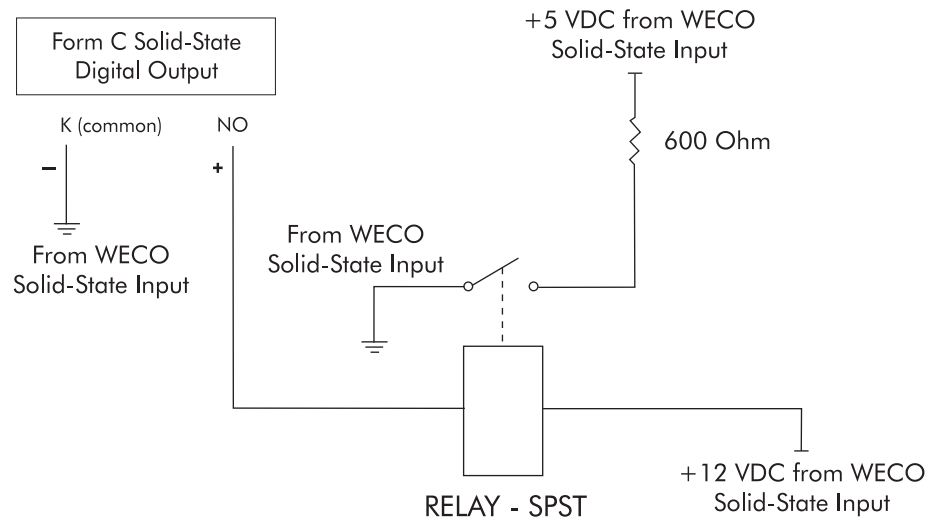

Configuring Test Settings

When testing the meter, ensure the test parameters are suited to your testing methods. You may need to adjust the energy pulsing outputs' pulse rate (Kt value), pulse width and the test mode timeout.

Digital Outputs settings

Four Form C digital outputs are preconfigured for energy pulsing as follows:

- ◆ DO1 = Wh Delivered
- ◆ DO2 = Wh Received
- ◆ DO3 = varh Delivered
- ◆ DO4 = varh Received

LED pulser settings

Two LEDs on the front panel are preconfigured for energy pulsing -- one for **Wh** and one for **varh**. The adjacent smaller infrared outputs are connected to the LEDs and pulse at the same rate. You may need to increase the pulse rate if the LED does not pulse.

Changing the energy pulse rate from the Front Panel

You cannot change the energy pulse rate from the meter's front panel.

Changing the energy pulse rate in ION Setup

1. Open the Setup Assistant in ION Setup.
2. Navigate to Pulsing outputs.

For **LEDs**, select LED Pulsing and click on the tab of the LED you want to configure. Edit the Wh and varh values as desired.

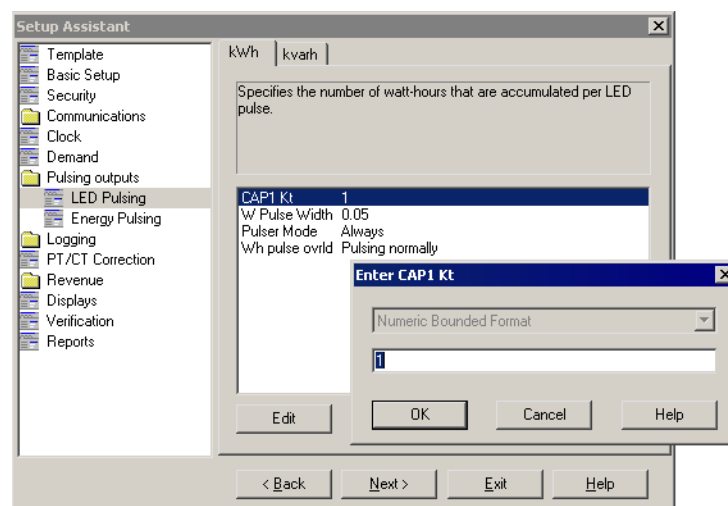

For **Digital Outputs**, select Energy Pulsing and click on the tab of the energy pulsing value you want to configure. Edit the settings as desired.

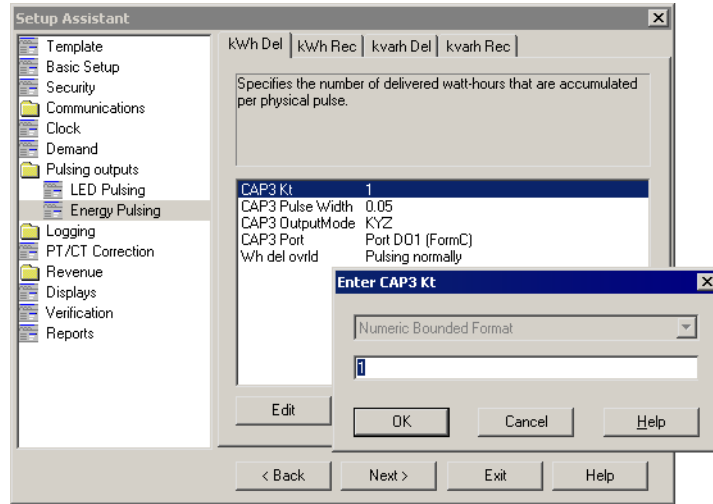

Changing the energy pulse rate in Designer

1. Open the meter using Designer software and double-click the Pulse Frequency folder in Energy Pulsing Setup.
2. Right-click the Calibration Pulser module you want to modify.
3. Double-click the register you want, make your change and click OK.
4. Click the Save icon (or choose Send & Save from the File menu).

The Kt value entered defines how much energy the module accumulates before a pulse is sent to the hardware channel. The front panel Wh and varh LEDs are factory set to the same pulse rate.

Test Points

NOTE

It is recommended that you test the ION 8800 meter at Full and Light Loads.

Wh test points

It is common practice to test these points:

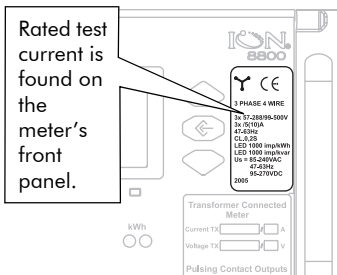

Wh Test Point	Specifications
Full Load	100% of the rated current, test voltage and rated frequency at unity power factor, or one (1). ¹
Light Load	10% of the rated current, test voltage and rated frequency at unity power factor, or one (1).
Lagging Power Factor	100% of the rated current, test voltage and rated frequency at 0.50 lagging power factor (current lagging voltage by 60° phase angle).

¹ The rated test current is found on the ION 8800 meter front panel label.

varh points

It is common practice to test these points:

kvarh Test Point	Specifications
Full Load	100% of the rated current, test voltage and rated frequency at zero power factor (current lagging voltage by 90° phase angle).
Light Load	10% of the rated current, test voltage and rated frequency at zero power factor (current lagging voltage by 90° phase angle).
Lagging Power Factor	100% of the rated current, test voltage and rated frequency at 0.50 lagging power factor (current lagging voltage by 60° phase angle).

Index

A

- accuracy testing
 - control equipment 222
 - test harness 221
 - test points 224
 - test procedure 220
 - test settings 223
- alarm LED 134
- alarm server 196
 - configuring 197
 - remote site event notification 197
- Alert module 200
- alerting
 - via alphanumeric pager 198
 - via email 199
 - via numeric pager 198
- alphanumeric pager alerts 198
- ALT Config button 24
- ALT Config menu 36, 67
- alt mode
 - display screens 176
 - switching to 29
 - time of use screens 177

B

- basic setup
 - configuring 44
- basic setup menu 32
- bus wiring 73
- buttons
 - spare 25
 - using navigation 32

C

- Calibration Pulser module 23, 140
- calibration pulsing 134
- CBEMA/ITI 168, 216
- clock
 - configuring 116
 - meter battery 118
 - timesynch source setup 53
- Clock module 117
- communications
 - available protocols 77
 - configuring 77
 - connections 71
 - Ethernet 75
 - internal modem 76
 - LEDs 87
 - optical 72
 - RS-232 74
 - RS-485 72
- Communications module 77
- configuring leading zeros 173

- configuring parameter titles 174
- confirming setup changes 32
- CTR-21 compliant modems 83

D

- data logging 144
 - configuring 144
 - MeterM@il 85
 - time-stamping 119
 - viewing 150
- Data Recorder module 146
- daylight savings time 34, 117
- demand forgiveness 124
- demand reset button 24, 179, 191
- Digital Input module 135
- digital inputs 135
- digital outputs 67, 132
- DIN rack 13
- display setup menu 35
- displays
 - disk simulator 28
 - histogram 27
 - nameplate and event log 27
 - numeric 26
 - phasor 28
 - status bar 26
 - time and date 28
 - time stamped 28
 - types 26
- DNP 3.0 57, 65, 77
 - configuring 112
 - factory configuration 112

E

- EEM 11
- email alerts 85, 199
- EN50160
 - logging 150
 - Modbus modules 97
 - power quality 166
 - Relative Setpoint modules 203
 - report 216
- energy demand log 146, 149
- energy pulsing 132
 - configuring 138
 - customizing 141
 - varh LED 141
 - watt-hour LED 141
- Essailec connector 71, 129, 222
- EtherGate 76, 81, 107
- Ethernet 32, 56
 - Alert module 196
 - configuration 80
 - connections 75

- LEDs 87
 - network setup menu 33
 - using DNP 3.0 over 112
 - using Modbus over 91
- Ethernet Communications module 80
- ethernet setup 33
- event codes 118
- Event Log Controller module 152
- event logging 152
 - displaying 153
- event priority 152
- external ION events 152
- external modem connections 75

F

- factory configuration 39
- Factory module 38, 86
- Form A relays 15, 132
- Form C relays 15, 132, 222, 223
- format setup menu 34
- front panel
 - accessing the setup menu 31
 - Ack alarms 36
 - ALT Config button 24
 - ALT Config menu 36
 - com ports setup 33
 - configuring leading zeros 173
 - configuring parameter titles 174
 - configuring the meter with 31
 - demand reset button 24
 - display setup 35
 - ethernet setup 33
 - features 22
 - format setup 34
 - LED pulsers 23
 - Master Reset button 24
 - modifying password 35
 - navigation buttons 23
 - operational LEDs 23
 - optical port 23
 - security setup 35
 - TEST mode button 24
 - viewing number of nines data 207
 - web config 36

G

- getting more information 20

H

- harmonics displays 177
- histogram displays 27, 177
- historic data logging 148
- HyperTerminal 86

I

- I/O
 - combinations 130
 - configuring 136
 - digital inputs 15, 135

- digital outputs 15, 132
- indicator LED 134
- instantaneous measurements 177
- internet connectivity 85
- ION Enterprise reporting 149
- ION software
 - alerting via alarm server 196
- IRIG-B 119

L

- LEDs
 - alarm 134
 - communications 87
 - energy pulsing 140
 - indicator 134
 - operational 23
 - pulsers 23
- logging
 - changing parameters 146
 - default capacity 146
 - default configuration 148
 - dip/swell 149
 - EN50160 150
 - harmonics 149
 - historical data 148
 - loss log 149
 - recording capacity 154
 - revenue 148
 - transient 149

M

- Mains Signalling Evaluation module 166
- manual symbols 18
- manual terminology 19
- Master Reset button 24
- measured parameters 12
- memory usage 154
- meter applications 10
- meter battery 118
- meter feature sets 12
- meter lock 36
- MeterM@il 85
- Modbus
 - configuring 109
 - meter as master 108
 - meter as slave 91
 - modules for mastering 108
- Modbus Slave module 92
- Modbus/TCP 107
- modem connections 76
- modem initialization strings 83
- ModemGate 84
- modes of operation 29
- MV-90 148

N

- nameplate 27
- navigation buttons 23
- norm mode 29

- display screens 175
- number of nines 207
- numeric displays 26
- numeric pager alerting 198

O

- optical port 23, 72
- out of range screen 32
- over condition monitoring 203

P

- password 35, 49, 107
- peak demand displays 178
- Periodic Timer module 147, 211
- phasor diagram 177
- phasor diagram displays 28
- Power Meter module 46, 86, 138, 141
- Pulser module 139

R

- Relative Setpoint module 203

S

- Sag/Swell module 167, 208
- seasons 162
- security
 - advanced 59
 - device access for ION services 62
 - disabling via front panel 36
 - modifying password 35
 - revenue metering 67
 - standard 49
 - time sync considerations 52
- security setup menu 35
- serial com settings 33
- serial communications setup 78
- setup menu
 - accessing via front panel 31
 - basic 32
 - com ports 33
 - configuring using navigation buttons 32
 - confirming changes 32
 - network setup 33
 - returning to previous screen 32
 - serial com settings 33
- Sliding Window Demand module 123
- software support 16
- spare button 25
- status bar 26

T

- Telnet 86
- test harness 221
- TEST mode
 - displays screens 179
 - LED energy pulsing 179
 - switching to 30, 179
 - time out 186
- TEST mode button 24

- test points 224
- test settings 223
- Time of Use module 162
- TOU displays 177
- TOU Program Manager 163
- Transient module 168

U

- unit ID 33, 79, 84
- using this guide 18

V

- vector diagram 177

W

- Waveform Recorder module 146
- web config 52
- WebMeter 85
- WebReach 16, 86
- WECO 222

MRP: 70000-0285-00
Revision Date: June 26, 2006